

Long-life grade capacitors

Applications

- Switch-mode power supplies in industrial and entertainment electronics
- Frequency converters

Features

- Long useful life
- High reliability and high ripple current capability
- Low equivalent series resistance *ESR*
- High *CU* product, i.e. compact
- Different case sizes available for each capacitance value

Construction

- Charge-discharge proof, polar
- Aluminum case, fully insulated
- Snap-in solder pins to hold component in place on PC-board
- Minus pole marking on case surface
- Minus pole not insulated from case
- Overload protection (safety vent)

Terminals

- Standard version with 2 terminals
2 lengths available: 6,3 and 4,5 mm
- 3 terminals: length 4,5 mm
(terminal arrangement ensures correct insertion)

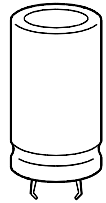

KAL0274-A

Specifications and characteristics in brief

Rated voltage U_R	160 ... 450 VDC	
Surge voltage U_S	$1,15 \cdot U_R$ (for $U_R \leq 250$ VDC) $1,10 \cdot U_R$ (for $U_R \geq 385$ VDC)	
Rated capacitance C_R	47 ... 2 200 μ F	
Capacitance tolerance	$\pm 20 \% \triangleq M$	
Leakage current I_L (5 min, 20 °C)	$I_L \leq 0,3 \mu A \cdot \left(\frac{C_R}{\mu F} \cdot \frac{U_R}{V} \right)^{0,7} + 4 \mu A$	
Self-inductance L_{ESL}	Approx. 20 nH	
Useful life 85 °C; U_R ; I_{R-} 40 °C; U_R ; $1,4 \cdot I_{R-}$	> 10 000 h > 200 000 h	Requirements: $\Delta C/C \leq \pm 30 \%$ of initial value $ESR \leq 3$ times initial specified limit $I_L \leq$ initial specified limit Failure percentage: $\leq 1 \%$ Failure rate: ≤ 50 fit ($\leq 50 \cdot 10^{-9}/h$) (for definiton "fit", refer to chapter "Quality", page 62)
Voltage endurance test 85 °C; U_R	5 000 h	Post test requirements: $\Delta C/C \leq \pm 10 \%$ of initial value $ESR \leq 1,3$ times initial specified limit $I_L \leq$ initial specified limit
Vibration resistance	To IEC 60068-2-6, test Fc: displacement amplitude 0,35 mm, frequency range 10 ... 55 Hz, acceleration max. 5 g, duration 3×2 h	
IEC climatic category	To IEC 60068-1: $U_R \leq 400$ VDC: 40/085/56 (– 40 °C/+ 85 °C/56 days damp heat test) $U_R \geq 420$ VDC: 25/085/56 (– 25 °C/+ 85 °C/56 days damp heat test)	
Detail specification	Similar to CECC 30301-811	
Sectional specification	IEC 60384-4	

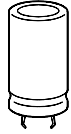
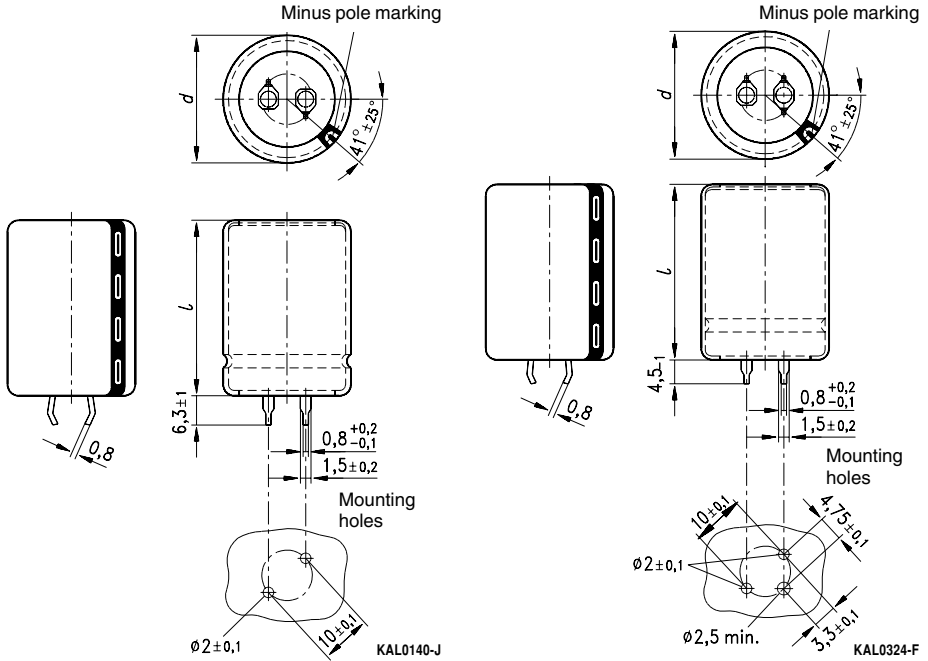
Dimensional drawings

Snap-in terminals, standard (length $6,3 \pm 1$ mm). Also available in a shorter version with a length of $4,5 - 1$ mm. For packing mode and ordering example see next page.

Snap-in capacitors are also available with 3 terminals (length $4,5 - 1$ mm).

For packing mode and ordering example see next page.

Dimensions (mm)		Approx. weight (g)	Packing units (pieces)
$d + 1$	$l \pm 2$		
22	25	9	160
22	30	12	160
22	35	15	160
22	40	18	160
25	25	13	130
25	30	17	130
25	35	19	130
25	40	22	130

Dimensions (mm)		Approx. weight (g)	Packing units (pieces)
$d + 1$	$l \pm 2$		
30	25	17	80
30	30	23	80
30	35	29	80
30	40	36	80
30	45	41	80
30	50	47	80
35	35	36	60
35	40	41	60
35	45	57	60
35	50	72	60



B43501

Long Life – 85 °C

Packing of snap-in capacitors



For ecological reasons the packing is pure cardboard. Components can be withdrawn (in full or in part) in the correct position for insertion.

Ordering codes

Snap-in terminals Version	Identification in 3rd block of ordering code
Standard terminals (6,3 ± 1) mm	M000
Short terminals (4,5 – 1) mm	M007
3 terminals (4,5 – 1) mm	M002

Ordering example:

B43501A3107M007 } snap-in capacitor with short terminals
B43501A3107M002 } snap-in capacitor with 3 terminals

Overview of available types

U_R (VDC)	160	200	250	385	400	420	450
C_R (μ F)	Case dimensions $d \times l$ (mm)						
47							22 × 25
68				22 × 25	22 × 25		22 × 30 25 × 25
100				22 × 30 25 × 25	22 × 30 25 × 25	22 × 30 25 × 25	22 × 40 25 × 30 30 × 25
120					22 × 35	25 × 30	
150			22 × 25	22 × 40 25 × 30	22 × 40 30 × 25	22 × 40 25 × 35	25 × 40 30 × 30
180					30 × 30	25 × 30 30 × 33	30 × 35
220	22 × 25	22 × 25	22 × 30 25 × 25	25 × 40 30 × 30	25 × 40 30 × 35	25 × 40 30 × 35	30 × 40
270					30 × 35	30 × 35 35 × 30	30 × 45
330	22 × 30	22 × 30 25 × 25	22 × 40 25 × 30	30 × 40	30 × 45	30 × 45 35 × 35	35 × 40
390					30 × 50	30 × 50	
470	22 × 35	22 × 40 30 × 25	25 × 40 30 × 30	35 × 40	35 × 45	35 × 45	35 × 50
560				35 × 45	35 × 50	35 × 50	
680	25 × 35	25 × 40 30 × 30	30 × 40				
1 000	30 × 35	30 × 40 35 × 35	35 × 40				
1 500	30 × 45	35 × 45					
2 200	35 × 50						

The capacitance and voltage ratings listed above are available in different cases upon request. Other voltage and capacitance ratings are also available upon request.

Technical data and ordering codes

U_R	C_R 100 Hz 20 °C μF	Case dimensions $d \times l$ mm	ESR_{typ} 100 Hz 20 °C mΩ	ESR_{max} 100 Hz 20 °C mΩ	Z_{max} 10 kHz 20 °C mΩ	$I_{~max}$ 100 Hz 40 °C A	$I_{~R}^{(1)}$ 100 Hz 85 °C A	Ordering code ²⁾
160	220	22 × 25	530	910	730	2,4	1,1	B43501A1227M000
	330	22 × 30	360	610	490	3,2	1,4	B43501A1337M000
	470	22 × 35	250	430	350	4,0	1,8	B43501A1477M000
	680	25 × 35	180	300	240	5,2	2,4	B43501A1687M000
	1 000	30 × 35	120	200	160	6,9	3,1	B43501A1108M000
	1 500	30 × 45	80	140	120	9,2	4,2	B43501A1158M000
	2 200	35 × 50	60	91	80	13	5,8	B43501A1228M000
200	220	22 × 25	380	610	490	2,4	1,1	B43501A2227M000
	330	22 × 30	260	410	330	3,2	1,4	B43501A2337M000
	330	25 × 25	260	410	330	3,2	1,5	B43501J2337M000
	470	22 × 40	180	290	240	4,2	1,9	B43501A2477M000
	470	30 × 25	180	290	350	4,2	1,9	B43501J2477M000
	680	25 × 40	130	200	160	5,5	2,5	B43501A2687M000
	680	30 × 30	130	200	160	5,4	2,4	B43501J2687M000
	1 000	30 × 40	83	140	120	7,2	3,3	B43501A2108M000
	1 000	35 × 35	83	140	120	7,6	3,5	B43501J2108M000
	1 500	35 × 45	56	90	80	10	4,6	B43501A2158M000
	250	150	22 × 25	560	890	800	2,0	0,91
220		22 × 30	380	610	500	2,6	1,2	B43501B2227M000
220		25 × 25	380	610	490	2,6	1,2	B43501K2227M000
330		22 × 40	260	410	330	3,5	1,6	B43501B2337M000
330		25 × 30	260	410	330	3,4	1,6	B43501K2337M000
470		25 × 40	180	290	240	4,5	2,1	B43501B2477M000
470		30 × 30	180	290	240	4,5	2,0	B43501K2477M000
680		30 × 40	130	200	160	5,9	2,7	B43501B2687M000
1 000		35 × 40	83	140	120	8,0	3,6	B43501B2108M000

Preferred types

1) 120 Hz conversion factor of ripple current: $I_{~}(120 \text{ Hz}) = 1,03 \cdot I_{~}(100 \text{ Hz})$

2) Ordering code for standard terminals (6,3 mm).

To determine the ordering code for short terminals (4,5 mm) and 3 terminals (4,5 mm) see page 238.

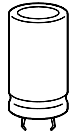

U_R	C_R 100 Hz 20 °C	Case dimensions $d \times l$ mm	ESR_{typ} 100 Hz 20 °C mΩ	ESR_{max} 100 Hz 20 °C mΩ	Z_{max} 10 kHz 20 °C mΩ	$I_{~max}$ 100 Hz 40 °C A	$I_{~R}^{(1)}$ 100 Hz 85 °C A	Ordering code ²⁾
385	68	22 × 25	980	1960	1570	1,3	0,61	B43501A3686M000
	100	22 × 30	670	1330	1070	1,7	0,79	B43501A3107M000
	100	25 × 25	670	1330	1070	1,8	0,80	B43501B3107M000
	150	22 × 40	450	890	720	2,4	1,1	B43501A3157M000
	150	25 × 30	450	890	720	2,3	1,0	B43501B3157M000
	220	25 × 40	310	610	490	3,1	1,4	B43501A3227M000
	220	30 × 30	310	610	490	3,1	1,4	B43501B3227M000
	330	30 × 40	210	410	330	4,1	1,9	B43501A3337M000
	470	35 × 40	150	290	240	5,5	2,5	B43501A3477M000
	560	35 × 45	120	240	200	6,2	2,8	B43501A3567M000
400	68	22 × 25	980	1960	1570	1,3	0,61	B43501A9686M000
	100	22 × 30	670	1330	1070	1,7	0,79	B43501A9107M000
	100	25 × 25	670	1330	1070	1,8	0,80	B43501B9107M000
	120	22 × 35	560	1100	890	2,0	0,92	B43501A9127M000
	150	22 × 40	450	890	720	2,4	1,1	B43501A9157M000
	150	30 × 25	450	890	720	2,4	1,1	B43501B9157M000
	180	30 × 30	370	740	600	2,7	1,2	B43501A9187M000
	220	25 × 40	310	610	490	3,1	1,4	B43501A9227M000
	220	30 × 35	310	610	490	3,2	1,5	B43501B9227M000
	270	30 × 35	250	490	400	3,5	1,6	B43501A9277M000
	330	30 × 45	210	410	330	4,3	2,0	B43501A9337M000
	390	30 × 50	180	340	280	4,8	2,2	B43501A9397M000
	470	35 × 45	150	290	240	5,7	2,6	B43501A9477M000
	560	35 × 50	120	240	200	6,4	2,9	B43501A9567M000

Preferred types

1) 120 Hz conversion factor of ripple current: $I_{~}(120 \text{ Hz}) = 1,03 \cdot I_{~}(100 \text{ Hz})$

2) Ordering code for standard terminals (6,3 mm).

To determine the ordering code for short terminals (4,5 mm) and 3 terminals (4,5 mm) see page 238.

B43501
Long Life – 85 °C

U_R	C_R 100 Hz 20 °C	Case dimensions $d \times l$ mm	ESR_{typ} 100 Hz 20 °C mΩ	ESR_{max} 100 Hz 20 °C mΩ	Z_{max} 10 kHz 20 °C mΩ	$I_{~max}$ 100 Hz 40 °C A	$I_{~R^{(1)}}$ 100 Hz 85 °C A	Ordering code ²⁾	
VDC	420	100	22 × 30	1330	1990	1600	1,74	0,79	B43501A0107M000
	100	25 × 25	1330	1990	1600	1,77	0,80	B43501E0107M000	
	120	22 × 30	1110	1660	1330	2,06	0,94	B43501A0127M000	
	150	22 × 40	890	1330	1070	2,37	1,08	B43501A0157M000	
	150	25 × 35	890	1330	1070	2,44	1,11	B43501E0157M000	
	180	25 × 35	740	1110	890	2,67	1,21	B43501A0187M000	
	180	30 × 30	740	1110	890	2,76	1,26	B43501E0187M000	
	220	25 × 40	610	910	730	3,11	1,41	B43501A0227M000	
	220	30 × 35	610	910	730	3,22	1,46	B43501E0227M000	
	270	30 × 35	500	740	590	3,57	1,62	B43501A0277M000	
	270	35 × 30	500	740	590	3,76	1,71	B43501E0277M000	
	330	30 × 45	410	610	490	4,32	1,96	B43501A0337M000	
	330	35 × 35	410	610	490	4,37	1,98	B43501E0337M000	
	390	30 × 50	350	520	410	4,89	2,22	B43501A0397M000	
	470	35 × 45	290	430	340	5,69	2,58	B43501A0477M000	
	560	35 × 50	240	360	290	6,45	2,93	B43501A0567M000	
VDC	450	47	22 × 25	2830	4240	3400	1,1	0,51	B43501A5476M000
	68	22 × 30	1960	2930	2350	1,4	0,65	B43501A5686M000	
	68	25 × 25	1960	2930	2350	1,5	0,66	B43501B5686M000	
	100	22 × 40	1330	1990	1600	1,9	0,88	B43501A5107M000	
	100	25 × 30	1330	1990	1600	1,9	0,86	B43501B5107M000	
	100	30 × 25	1330	1990	1600	1,9	0,90	B43501C5107M000	
	150	25 × 40	890	1330	1070	2,6	1,2	B43501A5157M000	
	150	30 × 30	890	1330	1070	2,5	1,1	B43501B5157M000	
	180	30 × 35	750	1100	890	2,9	1,3	B43501A5187M000	
	220	30 × 40	610	910	730	3,4	1,5	B43501A5227M000	
	270	30 × 45	500	740	600	3,9	1,8	B43501A5277M000	
	330	35 × 40	410	610	490	4,6	2,1	B43501A5337M000	
	470	35 × 50	290	430	350	5,9	2,7	B43501A5477M000	

Preferred types

1) 120 Hz conversion factor of ripple current: $I_{~(120\text{ Hz})} = 1,03 \cdot I_{~(100\text{ Hz})}$

2) Ordering code for standard terminals (6,3 mm).

To determine the ordering code for short terminals (4,5 mm) and 3 terminals (4,5 mm) see page 238.

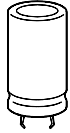

Useful life

depending on ambient temperature T_A under ripple current operating conditions¹⁾

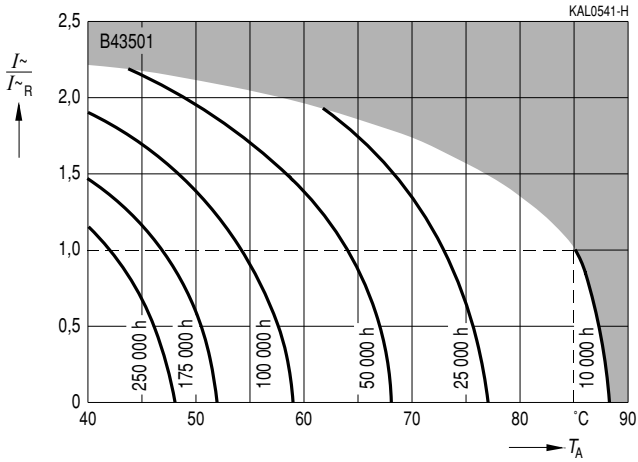

Frequency factor of permissible ripple current I_{\sim} versus frequency f

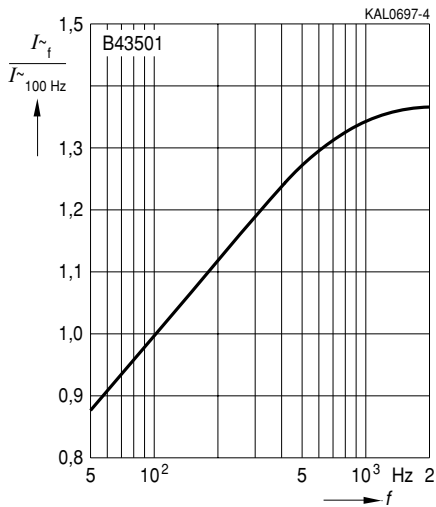

1) Refer to page 40 for an explanation on how to interpret the useful life graphs.

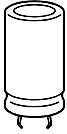

B43501

Long Life – 85 °C

Frequency characteristics of ESR

Typical behavior

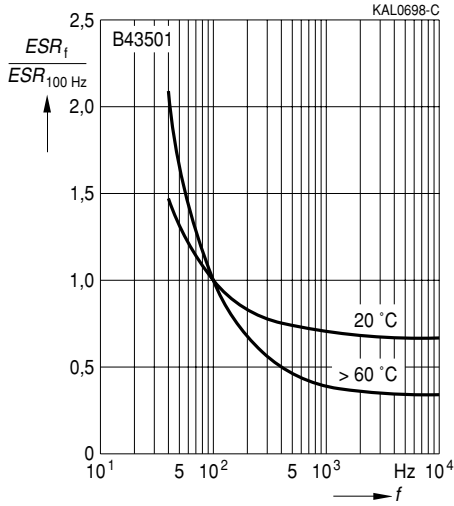

Impedance Z

versus frequency f

Typical behavior at 20 °C

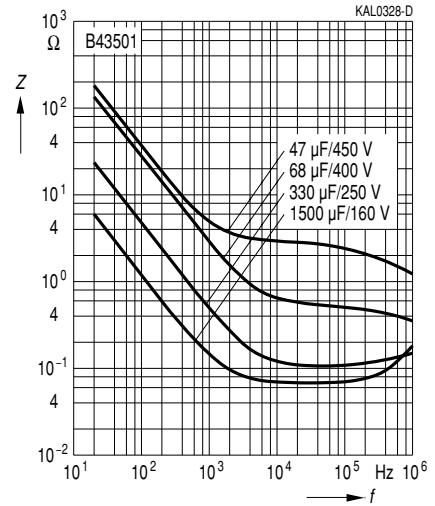

Herausgegeben von EPCOS AG

Unternehmenskommunikation, Postfach 80 17 09, 81617 München, DEUTSCHLAND

☎ ++49 89 636 09, FAX (0 89) 636-2 26 89

© EPCOS AG 2002. Vervielfältigung, Veröffentlichung, Verbreitung und Verwertung dieser Broschüre und ihres Inhalts ohne ausdrückliche Genehmigung der EPCOS AG nicht gestattet.

Bestellungen unterliegen den vom ZVEI empfohlenen Allgemeinen Lieferbedingungen für Erzeugnisse und Leistungen der Elektroindustrie, soweit nichts anderes vereinbart wird.

Diese Broschüre ersetzt die vorige Ausgabe.

Fragen über Technik, Preise und Liefermöglichkeiten richten Sie bitte an den Ihnen nächstgelegenen Vertrieb der EPCOS AG oder an unsere Vertriebsgesellschaften im Ausland. Bauelemente können aufgrund technischer Erfordernisse Gefahrstoffe enthalten. Auskünfte darüber bitten wir unter Angabe des betreffenden Typs ebenfalls über die zuständige Vertriebsgesellschaft einzuholen.

Published by EPCOS AG

Corporate Communications, P.O. Box 80 17 09, 81617 Munich, GERMANY

☎ ++49 89 636 09, FAX (0 89) 636-2 26 89

© EPCOS AG 2002. Reproduction, publication and dissemination of this brochure and the information contained therein without EPCOS' prior express consent is prohibited.

Purchase orders are subject to the General Conditions for the Supply of Products and Services of the Electrical and Electronics Industry recommended by the ZVEI (German Electrical and Electronic Manufacturers' Association), unless otherwise agreed.

This brochure replaces the previous edition.

For questions on technology, prices and delivery please contact the Sales Offices of EPCOS AG or the international Representatives.

Due to technical requirements components may contain dangerous substances. For information on the type in question please also contact one of our Sales Offices.