



Aluminum electrolytic capacitors

Single-ended capacitors

Series/Type: B41890
Date: December 2010

Long-life grade capacitors for automotive electronics and lighting applications

Applications

- High-reliability equipment in automotive, LED lighting and industrial electronics

Features

- High reliability and long useful life
- High ripple current capability
- Extra long useful life (10000 to 15000 h/105 °C)
- RoHS-compatible

Construction

- Charge-discharge proof, polar
- Aluminum case with insulating sleeve
- Minus pole marking on the insulating sleeve
- Case with safety vent

Delivery mode

Terminal configurations and packing:

- Bulk
- Taped, Ammo pack
- Cut (see chapter "Single-ended – Taping, packing and lead configurations, Cut leads (Chapter B)")
- Kinked (see chapter "Single-ended – Taping, packing and lead configurations, Kinked leads (Chapter B)")
- PAPR (protection against polarity reversal):
crimped leads, J leads, bent leads

Refer to chapter "Single-ended capacitors – Taping, packing and lead configurations" for further details.



Specifications and characteristics in brief

Rated voltage V_R	16 ... 50 V DC			
Surge voltage V_S	$1.15 \cdot V_R$			
Rated capacitance C_R	100 ... 6800 μF			
Capacitance tolerance	$\pm 20\% \triangleq M$			
Dissipation factor $\tan \delta$ (20 °C, 120 Hz)	For capacitance higher than 1000 μF add 0.02 for every increase of 1000 μF .			
	V_R (V DC)	16 ... 25	35	50
	$\tan \delta$ (max.)	0.17	0.12	0.10
Leakage current I_{leak} (20 °C, 5 min)	$I_{\text{leak}} = 0.01 \mu\text{A} \cdot \left(\frac{C_R}{\mu\text{F}} \cdot \frac{V_R}{\text{V}} \right)$ or 3 μA , whichever is greater			
Self-inductance ESL	Diameter (mm)	8 ... 12.5	16	18
	ESL (nH)	20	26	34
Useful life 105 °C; V_R ; $I_{\text{AC,R}}$	> 10000 h for $\varnothing \leq 10$ mm > 15000 h for $\varnothing \geq 12.5$ mm			
Requirements	$\Delta C/C \leq \pm 35\%$ of initial value $\tan \delta \leq 3$ times initial specified limit $I_{\text{leak}} \leq$ initial specified limit			
Voltage endurance test 105 °C; V_R	10000 h for $\varnothing \leq 10$ mm 15000 h for $\varnothing \geq 12.5$ mm			
Post test requirements	$\Delta C/C \leq \pm 30\%$ of initial value $\tan \delta \leq 2$ times initial specified limit $I_{\text{leak}} \leq$ initial specified limit			
Vibration resistance test	To IEC 60068-2-6, test Fc: Frequency range 10 Hz ... 2 kHz, displacement amplitude max. 1.5 mm, acceleration max. 20 g, duration 3×2 h. Capacitor rigidly clamped by the aluminum case.			
IEC climatic category	To IEC 60068-1: 55/105/56 (–55 °C/+105 °C/56 days damp heat test)			
Sectional specification	IEC 60384-4, AEC-Q200			



B41890

Extended useful life – 105 °C

Dimensional drawing

With stand-off rubber seal

Diameters (mm): 10, 12.5, 16, 18

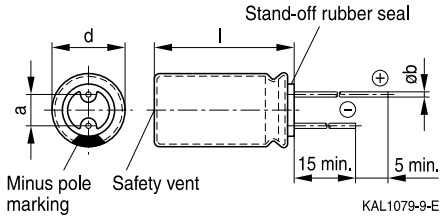

Dimensions and weights

Dimensions (mm)				Approx. weight
d +0.5	l	a ±0.5	b	g
10	16 +1.0	5.0	0.60 ±0.05	1.9
10	20 +2.0	5.0	0.60 ±0.05	2.6
12.5	20 +2.0	5.0	0.60 ±0.05	3.6
12.5	25 +2.0	5.0	0.60 ±0.05	4.5
12.5	30 +2.0	5.0	0.80 ±0.05	5.3
12.5	40 +2.0	5.0	0.80 ±0.05	7.4
16	20 +2.0	7.5	0.80 ±0.05	5.5
16	25 +2.0	7.5	0.80 ±0.05	7.5
16	31.5 +2.0	7.5	0.80 ±0.05	7.8
18	20 +2.0	7.5	0.80 ±0.1	8.0
18	25 +2.0	7.5	0.80 ±0.1	9.0
18	31.5 +2.0	7.5	0.80 ±0.1	11.0
18	35 +2.0	7.5	0.80 ±0.1	13.0
18	40 +2.0	7.5	0.80 ±0.1	16.0

Overview of available types

V_R (V DC)	16	25	35	50
	Case dimensions $d \times l$ (mm)			
C_R (μ F)				
100		10 × 16	10 × 16	10 × 16
120		10 × 16	10 × 16	10 × 16
150		10 × 16	10 × 16	10 × 16
180		10 × 16	10 × 16	10 × 20
220	10 × 16	10 × 16	10 × 16	10 × 20
270	10 × 16	10 × 16	10 × 20	12.5 × 20
330	10 × 16	10 × 16	10 × 20	12.5 × 20
390	10 × 16	10 × 16	12.5 × 20	12.5 × 25
470	10 × 16	10 × 20	12.5 × 20	12.5 × 25 16 × 20
560	10 × 16	10 × 20	12.5 × 25	16 × 20
680	10 × 16	10 × 20	12.5 × 25	16 × 25 18 × 20
820	10 × 20	12.5 × 20	16 × 20	16 × 31.5
1000	12.5 × 20	12.5 × 25 16 × 20	12.5 × 40 16 × 25 18 × 20	16 × 31.5
1200	12.5 × 20	12.5 × 25	16 × 25 18 × 20	18 × 31.5
1500	12.5 × 25	16 × 20	16 × 31.5	18 × 35
1800	12.5 × 25	12.5 × 40 16 × 25 18 × 20	18 × 31.5	18 × 40
2200	12.5 × 30 16 × 20	16 × 31.5 18 × 25	18 × 35	
2700	16 × 25 18 × 20	16 × 31.5	18 × 40	
3300	16 × 31.5	18 × 31.5		
3900	16 × 31.5	18 × 35		
4700	18 × 31.5	18 × 40		
5600	18 × 35			
6800	18 × 40			

Other voltage and capacitance ratings are available upon request.

Technical data and ordering codes

C_R	Case dimensions	ESR_{max} 10 kHz −40 °C	ESR_{max} 10 kHz 20 °C	Z_{max} 100 kHz 20 °C	$I_{AC,R}$ 100 kHz 105 °C	Ordering code (composition see below)
120 Hz 20 °C μF	d × l mm	Ω	Ω	Ω	mA	
$V_R = 16 V DC$						
220	10 × 16	1.104	0.138	0.115	965	B41890A4227M***
270	10 × 16	1.104	0.138	0.115	965	B41890A4277M***
330	10 × 16	1.104	0.138	0.115	965	B41890A4337M***
390	10 × 16	1.104	0.138	0.115	965	B41890A4397M***
470	10 × 16	1.104	0.138	0.115	965	B41890A4477M***
560	10 × 16	1.104	0.138	0.115	965	B41890A4567M***
680	10 × 16	1.104	0.138	0.115	965	B41890A4687M***
820	10 × 20	0.595	0.074	0.062	1205	B41890A4827M***
1000	12.5 × 20	0.528	0.066	0.055	1820	B41890A4108M***
1200	12.5 × 20	0.528	0.066	0.055	1820	B41890A4128M***
1500	12.5 × 25	0.365	0.046	0.038	2280	B41890A4158M***
1800	12.5 × 25	0.365	0.046	0.038	2280	B41890A4188M***
2200	12.5 × 30	0.298	0.037	0.031	2860	B41890A4228M***
2200	16 × 20	0.365	0.046	0.038	2280	B41890B4228M***
2700	16 × 25	0.288	0.036	0.030	2860	B41890A4278M***
2700	18 × 20	0.336	0.042	0.035	2490	B41890B4278M***
3300	16 × 31.5	0.240	0.030	0.025	3160	B41890A4338M***
3900	16 × 31.5	0.240	0.030	0.025	3160	B41890A4398M***
4700	18 × 31.5	0.230	0.029	0.024	3500	B41890A4478M***
5600	18 × 35	0.211	0.026	0.022	3840	B41890A4568M***
6800	18 × 40	0.173	0.022	0.018	4230	B41890A4688M***

Composition of ordering code

*** = Version

000 = for standard leads, bulk

001 = for kinked leads, bulk (for d × l = 10 × 20 ... 12.5 × 25 mm and Ø 16 ... 18 mm)

002 = for cut leads, bulk (for Ø 10 ... 18 mm, excluding d × l = 12.5 × 30/40 mm)

003 = for crimped leads, blister (for Ø 16 ... 18 mm)

004 = for J leads, blister (for Ø 10 ... 18 mm, excluding d × l = 12.5 × 30/40 and 18 × 40 mm)

008 = for taped leads, Ammo pack, lead spacing F = 5.0 mm (for d × l = 10 × 16 ... 12.5 × 25 mm)

009 = for taped leads, Ammo pack, lead spacing F = 7.5 mm (for Ø 16 mm and d × l = 18 × 20 ... 18 × 31.5 mm)

012 = for bent 90° leads, blister (for Ø 16 ... 18 mm)

Technical data and ordering codes

C_R	Case dimensions	ESR_{max} 10 kHz -40 °C	ESR_{max} 10 kHz 20 °C	Z_{max} 100 kHz 20 °C	$I_{AC,R}$ 100 kHz 105 °C	Ordering code (composition see below)
μF	d × l mm	Ω	Ω	Ω	mA	
$V_R = 25 V DC$						
100	10 × 16	1.104	0.138	0.115	965	B41890A5107M***
120	10 × 16	1.104	0.138	0.115	965	B41890A5127M***
150	10 × 16	1.104	0.138	0.115	965	B41890A5157M***
180	10 × 16	1.104	0.138	0.115	965	B41890A5187M***
220	10 × 16	1.104	0.138	0.115	965	B41890A5227M***
270	10 × 16	1.104	0.138	0.115	965	B41890A5277M***
330	10 × 16	1.104	0.138	0.115	965	B41890A5337M***
390	10 × 16	1.104	0.138	0.115	965	B41890A5397M***
470	10 × 20	0.595	0.074	0.062	1205	B41890A5477M***
560	10 × 20	0.595	0.074	0.062	1205	B41890A5567M***
680	10 × 20	0.595	0.074	0.062	1205	B41890A5687M***
820	12.5 × 20	0.528	0.066	0.055	1820	B41890A5827M***
1000	12.5 × 25	0.365	0.046	0.038	2280	B41890A5108M***
1000	16 × 20	0.365	0.046	0.038	2280	B41890B5108M***
1200	12.5 × 25	0.365	0.046	0.038	2280	B41890A5128M***
1500	16 × 20	0.365	0.046	0.038	2280	B41890A5158M***
1800	12.5 × 40	0.250	0.031	0.026	3340	B41890A5188M***
1800	16 × 25	0.288	0.036	0.030	2860	B41890B5188M***
1800	18 × 20	0.336	0.042	0.035	2490	B41890C5188M***
2200	16 × 31.5	0.240	0.030	0.025	3160	B41890A5228M***
2200	18 × 25	0.269	0.034	0.028	3010	B41890B5228M***
2700	16 × 31.5	0.240	0.030	0.025	3160	B41890A5278M***
3300	18 × 31.5	0.230	0.029	0.024	3500	B41890A5338M***
3900	18 × 35	0.211	0.026	0.022	3840	B41890A5398M***
4700	18 × 40	0.173	0.022	0.018	4230	B41890A5478M***

Composition of ordering code

*** = Version

- 000 = for standard leads, bulk
- 001 = for kinked leads, bulk (for d × l = 10 × 20 ... 12.5 × 25 mm and \varnothing 16 ... 18 mm)
- 002 = for cut leads, bulk (for \varnothing 10 ... 18 mm, excluding d × l = 12.5 × 30/40 mm)
- 003 = for crimped leads, blister (for \varnothing 16 ... 18 mm)
- 004 = for J leads, blister (for \varnothing 10 ... 18 mm, excluding d × l = 12.5 × 30/40 and 18 × 40 mm)
- 008 = for taped leads, Ammo pack, lead spacing F = 5.0 mm (for d × l = 10 × 16 ... 12.5 × 25 mm)
- 009 = for taped leads, Ammo pack, lead spacing F = 7.5 mm (for \varnothing 16 mm and d × l = 18 × 20 ... 18 × 31.5 mm)
- 012 = for bent 90° leads, blister (for \varnothing 16 ... 18 mm)

B41890
Extended useful life – 105 °C
Technical data and ordering codes

C_R	Case dimensions	ESR_{max}	ESR_{max}	Z_{max}	$I_{AC,R}$	Ordering code (composition see below)
120 Hz 20 °C μF	$d \times l$ mm	10 kHz –40 °C Ω	10 kHz 20 °C Ω	100 kHz 20 °C Ω	100 kHz 105 °C mA	
$V_R = 35 V DC$						
100	10 × 16	1.104	0.138	0.115	965	B41890A7107M***
120	10 × 16	1.104	0.138	0.115	965	B41890A7127M***
150	10 × 16	1.104	0.138	0.115	965	B41890A7157M***
180	10 × 16	1.104	0.138	0.115	965	B41890A7187M***
220	10 × 16	1.104	0.138	0.115	965	B41890A7227M***
270	10 × 20	0.595	0.074	0.062	1205	B41890A7277M***
330	10 × 20	0.595	0.074	0.062	1205	B41890A7337M***
390	12.5 × 20	0.528	0.066	0.055	1820	B41890A7397M***
470	12.5 × 20	0.528	0.066	0.055	1820	B41890A7477M***
560	12.5 × 25	0.365	0.046	0.038	2280	B41890A7567M***
680	12.5 × 25	0.365	0.046	0.038	2280	B41890A7687M***
820	16 × 20	0.365	0.046	0.038	2280	B41890A7827M***
1000	12.5 × 40	0.250	0.031	0.026	3340	B41890A7108M***
1000	16 × 25	0.288	0.036	0.030	2860	B41890B7108M***
1000	18 × 20	0.336	0.042	0.035	2490	B41890C7108M***
1200	16 × 25	0.288	0.036	0.030	2860	B41890A7128M***
1200	18 × 20	0.336	0.042	0.035	2490	B41890B7128M***
1500	16 × 31.5	0.240	0.030	0.025	3160	B41890A7158M***
1800	18 × 31.5	0.230	0.029	0.024	3500	B41890A7188M***
2200	18 × 35	0.211	0.026	0.022	3840	B41890A7228M***
2700	18 × 40	0.173	0.022	0.018	4230	B41890A7278M***

Composition of ordering code

*** = Version

000 = for standard leads, bulk

 001 = for kinked leads, bulk (for $d \times l = 10 \times 20 \dots 12.5 \times 25$ mm and $\varnothing 16 \dots 18$ mm)

 002 = for cut leads, bulk (for $\varnothing 10 \dots 18$ mm, excluding $d \times l = 12.5 \times 30/40$ mm)

 003 = for crimped leads, blister (for $\varnothing 16 \dots 18$ mm)

 004 = for J leads, blister (for $\varnothing 10 \dots 18$ mm, excluding $d \times l = 12.5 \times 30/40$ and 18×40 mm)

 008 = for taped leads, Ammo pack, lead spacing $F = 5.0$ mm (for $d \times l = 10 \times 16 \dots 12.5 \times 25$ mm)

 009 = for taped leads, Ammo pack, lead spacing $F = 7.5$ mm (for $\varnothing 16$ mm and $d \times l = 18 \times 20 \dots$
 18×31.5 mm)

 012 = for bent 90° leads, blister (for $\varnothing 16 \dots 18$ mm)

Technical data and ordering codes

C_R	Case dimensions	ESR_{max}	ESR_{max}	Z_{max}	$I_{AC,R}$	Ordering code (composition see below)
120 Hz	$d \times l$	10 kHz	10 kHz	100 kHz	100 kHz	
20 °C	mm	-40 °C	20 °C	20 °C	105 °C	
μF		Ω	Ω	Ω	mA	
$V_R = 50 V DC$						
100	10 × 16	1.248	0.156	0.130	965	B41890A6107M***
120	10 × 16	1.248	0.156	0.130	965	B41890A6127M***
150	10 × 16	1.248	0.156	0.130	965	B41890A6157M***
180	10 × 20	0.672	0.084	0.070	1205	B41890A6187M***
220	10 × 20	0.672	0.084	0.070	1205	B41890A6227M***
270	12.5 × 20	0.576	0.072	0.060	1820	B41890A6277M***
330	12.5 × 20	0.576	0.072	0.060	1820	B41890A6337M***
390	12.5 × 25	0.413	0.052	0.043	2280	B41890A6397M***
470	12.5 × 25	0.413	0.050	0.043	2280	B41890A6477M***
470	16 × 20	0.403	0.052	0.042	2280	B41890B6477M***
560	16 × 20	0.403	0.050	0.042	2280	B41890A6567M***
680	16 × 25	0.326	0.041	0.034	2860	B41890A6687M***
680	18 × 20	0.365	0.046	0.038	2490	B41890B6687M***
820	16 × 31.5	0.269	0.034	0.028	3160	B41890A6827M***
1000	16 × 31.5	0.269	0.034	0.028	3160	B41890A6108M***
1200	18 × 31.5	0.259	0.032	0.027	3500	B41890A6128M***
1500	18 × 35	0.240	0.030	0.025	3840	B41890A6158M***
1800	18 × 40	0.192	0.024	0.020	4230	B41890A6188M***

Composition of ordering code

*** = Version

000 = for standard leads, bulk

 001 = for kinked leads, bulk (for $d \times l = 10 \times 20 \dots 12.5 \times 25$ mm and $\varnothing 16 \dots 18$ mm)

 002 = for cut leads, bulk (for $\varnothing 10 \dots 18$ mm, excluding $d \times l = 12.5 \times 30/40$ mm)

 003 = for crimped leads, blister (for $\varnothing 16 \dots 18$ mm)

 004 = for J leads, blister (for $\varnothing 10 \dots 18$ mm, excluding $d \times l = 12.5 \times 30/40$ and 18×40 mm)

 008 = for taped leads, Ammo pack, lead spacing $F = 5.0$ mm (for $d \times l = 10 \times 16 \dots 12.5 \times 25$ mm)

 009 = for taped leads, Ammo pack, lead spacing $F = 7.5$ mm (for $\varnothing 16$ mm and $d \times l = 18 \times 20 \dots 18 \times 31.5$ mm)

 012 = for bent 90° leads, blister (for $\varnothing 16 \dots 18$ mm)



B41890

Extended useful life – 105 °C

Useful life

depending on ambient temperature T_A under ripple current operating conditions¹⁾

$d = 10 \text{ mm}$

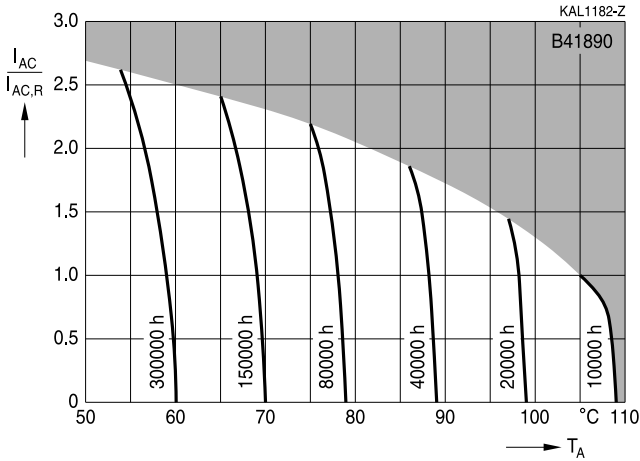

Useful life

depending on ambient temperature T_A under ripple current operating conditions¹⁾

$d \geq 12.5 \text{ mm}$

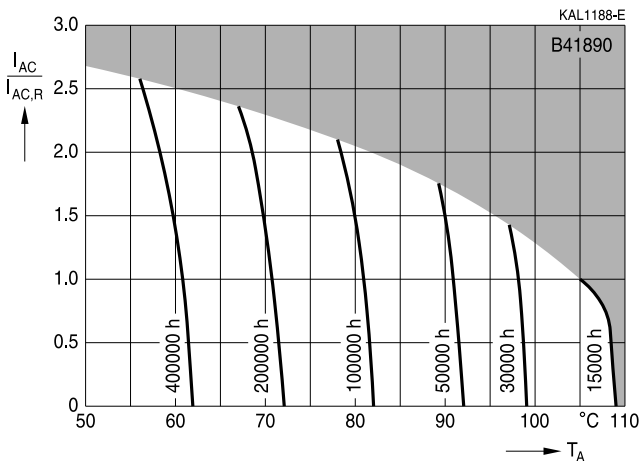

1) Refer to chapter "General technical information, 5.3 Calculation of useful life" for an explanation on how to interpret the useful life graphs.



Frequency factor of permissible ripple current I_{AC} versus frequency f

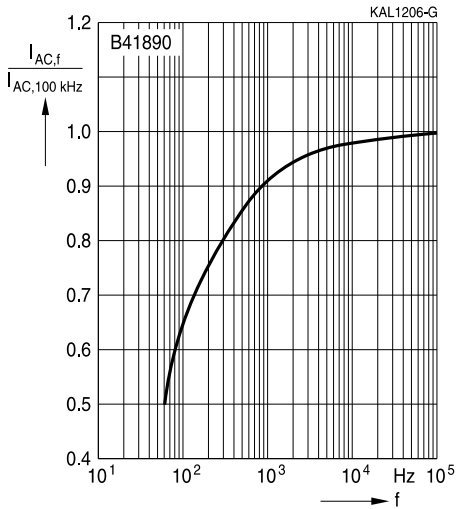



B41890

Extended useful life – 105 °C

Taping, packing and lead configurations

Taping

Single-ended capacitors are available taped in Ammo pack from diameter 4 to 18 mm as follows:

Lead spacing $F = 2.0$ mm ($\varnothing d = 4 \dots 5$ mm)

Lead spacing $F = 2.5$ mm ($\varnothing d = 4 \dots 6.3$ mm)

Lead spacing $F = 3.5$ mm ($\varnothing d = 8$ mm)

Lead spacing $F = 5.0$ mm ($\varnothing d = 4 \dots 12.5$ mm)

Lead spacing $F = 7.5$ mm ($\varnothing d = 16 \dots 18$ mm).

Lead spacing 2.0 mm ($\varnothing d = 4 \dots 5$ mm)

Last 3 digits of ordering code: 016

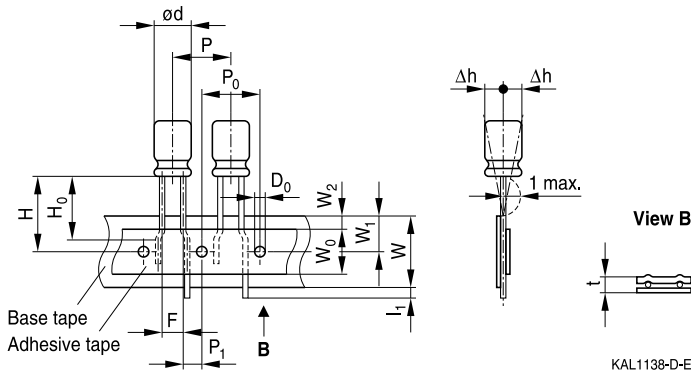

Dimensions in mm

$\varnothing d$	F	H	W	W_0	W_1	W_2	P	P_0	P_1	l_1	t	Δh	D_0
4 ... 5	2.0	18.5	18.0	7.0	9.0	3.0	12.7	12.7	5.10	1.0	0.7	1	4.0
	+0.8 -0.2	±0.75	±0.5	min.	±0.5	max.	±1.0	±0.3	±0.7	max.	±0.2	±1.0	±0.2

Lead spacing 2.5 mm ($\varnothing d = 4 \dots 6.3$ mm)

Last 3 digits of ordering code: 007

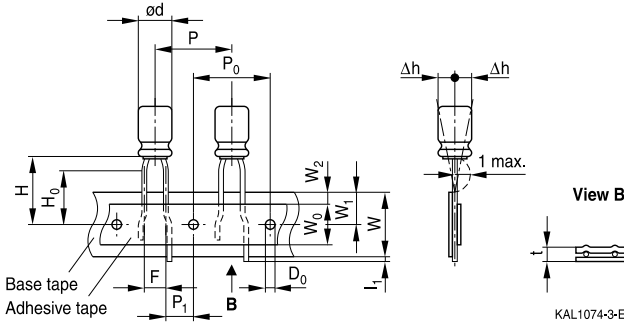
Dimensions in mm

$\varnothing d$	F	H	W	W_0	W_1	W_2	H_0	P	P_0	P_1	l_1	t	Δh	D_0
4 ... 6.3	2.5	18.5	18.0	5.5	9.0	1.5	16.0	12.7	12.7	5.1	1.0	0.7	1.0	4.0
Tolerance	+0.8 -0.2	± 0.75	± 0.5	min.	± 0.5	max.	± 0.5	± 1.0	± 0.2	± 0.5	max.	± 0.2	max.	± 0.2

Lead spacing 3.5 mm ($\varnothing d = 8$ mm)

Last 3 digits of ordering code: 006

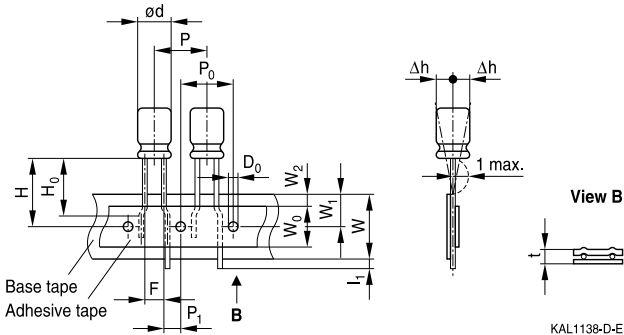
Dimensions in mm

$\varnothing d$	F	H	W	W_0	W_1	W_2	P	P_0	P_1	l_1	t	Δh	D_0
8	3.5	18.5	18.0	10	9.0	3.0	12.7	12.7	4.6	1.0	0.7	1.0	4.0
Tolerance	+0.8 -0.2	± 1.0	± 0.5	min.	± 0.5	max.	± 1.0	± 0.3	± 0.6	max.	± 0.2	max.	± 0.2

Leads can also run straight through the taping area. Taping is available up to dimensions $d \times l = 8 \times 15$ mm.



B41890

Extended useful life – 105 °C

Lead spacing 5.0 mm (∅ d = 4 ... 8 mm)

Last 3 digits of ordering code: 008

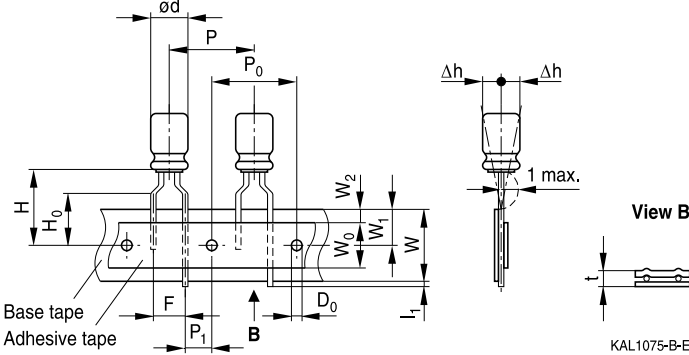

Lead spacing 5.0 mm (∅ d = 10 ... 12.5 mm)

Last 3 digits of ordering code: 008

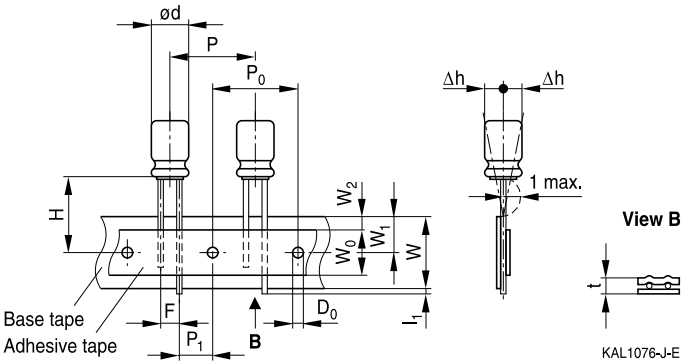

Dimensions in mm

∅ d	F	H	W	W ₀	W ₁	W ₂	H ₀	P	P ₀	P ₁	l ₁	t	Δh	D ₀
4 ... 6.3	5.0	18.5	18.0	5.5	9.0	1.5	16.0	12.7	12.7	3.85	1.0	0.6	1.0	4.0
8	5.0	20.0	18.0	10.0	9.0	1.5	16.0	12.7	12.7	3.85	1.0	0.6	1.0	4.0
10		19.0		12.5			–	12.7	12.7	3.85				
12.5		19.0		12.5			–	15.0	15.0	5.0				
Tolerance	+0.8 –0.2	±0.75	±0.5	min.	±0.5	max.	±0.5	±1.0	±0.2	±0.5	max.	+0.3 –0.2	max.	±0.2

Taping is available up to dimensions d × l = 10 × 31.5 mm and 12.5 × 25 mm.

Taping is not available for d × l = 8 × 20 mm.

Lead spacing 7.5 mm (∅ d = 16 ...18 mm)

Last 3 digits of ordering code: 009

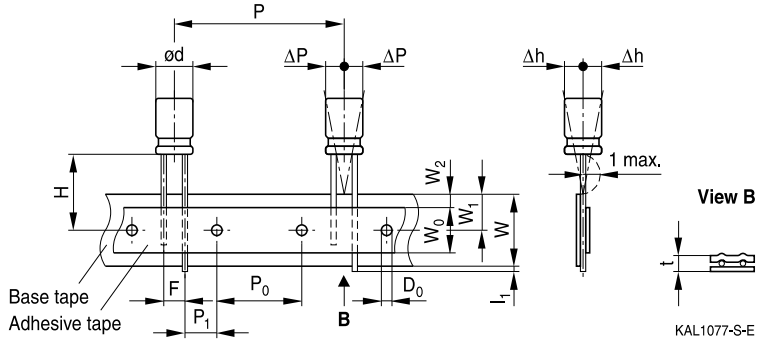
Dimensions in mm

$\varnothing d$	F	H	W	W_0	W_1	W_2	P	P_0	P_1	I_1	t	ΔP	Δh	D_0
16	7.5	18.5	18.0	12.5	9.0	1.5	30.0	15.0	3.75	1.0	0.7	0	0	4.0
18														
Tolerance	± 0.8	-0.5 $+0.75$	± 0.5	min.	± 0.5	max.	± 1.0	± 0.2	± 0.5	max.	± 0.2	± 1.0	± 1.0	± 0.2

 Taping is available up to dimensions $d \times l = 16 \times 31.5 \text{ mm}$ and $18 \times 31.5 \text{ mm}$.



B41890

Extended useful life – 105 °C

Cut or kinked leads

Single-ended capacitors are available with cut or kinked leads. Other lead configurations also available upon request.

Cut leads (Chapter A)

Available for series B41002, B41022, B41044, B41827, B41828, B43044, B43082, B43086, B43088, B43827, B43828.

Last 3 digits of ordering code: 002

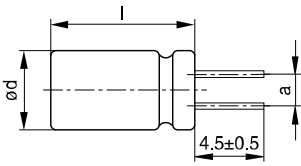

KAL1086-R

Case size d x l (mm)	Dimensions (mm) a ±0.5
4 x 7	1.5
5 x 7	2.0
5 x 11	2.0
6.3 x 7	2.5
6.3 x 11	2.5
8 x 7	3.5
8 x 11.5	3.5
8 x 15	3.5
8 x 20	3.5
10 x 12.5	5.0
10 x 16	5.0
10 x 20	5.0
10 x 25	5.0
10 x 31.5	5.0

Case size d x l (mm)	Dimensions (mm) a ±0.5
12.5 x 16	5.0
12.5 x 20	5.0
12.5 x 25	5.0
12.5 x 31.5	5.0
12.5 x 35.5	5.0
12.5 x 40	5.0
16 x 20	7.5
16 x 25	7.5
16 x 31.5	7.5
16 x 35.5	7.5
16 x 40	7.5
18 x 20	7.5
18 x 25	7.5
18 x 31.5	7.5
18 x 35.5	7.5
18 x 40	7.5



Cut leads (Chapter B)

Available for series B41858, B41859, B41863, B41866, B41868, B41888, B41890, B41896, B42824, B42851, B43866, B43867, B43890, B43896.

Last 3 digits of ordering code: 002

With stand-off rubber seal

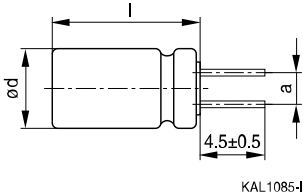

With flat rubber seal

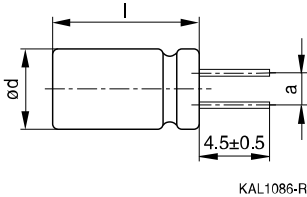

Case size $d \times l$ (mm)	Dimensions (mm) $a \pm 0.5$
10 × 12.5	5.0
10 × 16	5.0
10 × 20	5.0
12.5 × 20	5.0
12.5 × 25	5.0
16 × 20	7.5
16 × 25	7.5
16 × 31.5	7.5
16 × 35.5	7.5
18 × 20	7.5
18 × 25	7.5
18 × 31.5	7.5
18 × 35	7.5
18 × 40	7.5



B41890

Extended useful life – 105 °C

Kinked leads (Chapter A)

Available for series B41002, B41022, B41044, B41827, B41828, B43044, B43082, B43086, B43088, B43827, B43828.

Last 3 digits of ordering code: 001

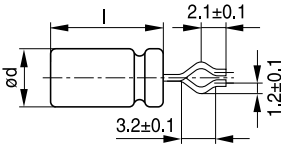

KAL1137-5

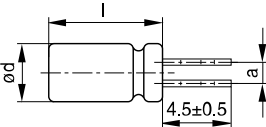

KAL1084-A

Case size d x l (mm)	Dimensions (mm) a ±0.5
4 x 7	1.5
5 x 7	2.0
5 x 11	2.0
6.3 x 7	2.5
6.3 x 11	2.5
8 x 7	3.5
8 x 11.5	3.5
8 x 15	3.5
8 x 20	3.5
10 x 12.5	5.0
10 x 16	5.0
10 x 20	5.0
10 x 25	5.0
10 x 31.5	5.0

Case size d x l (mm)	Dimensions (mm) a ±0.5
12.5 x 16	5.0
12.5 x 20	5.0
12.5 x 25	5.0
12.5 x 31.5	5.0
12.5 x 35.5	5.0
12.5 x 40	5.0
16 x 20	7.5
16 x 25	7.5
16 x 31.5	7.5
16 x 35.5	7.5
16 x 40	7.5
18 x 20	7.5
18 x 25	7.5
18 x 31.5	7.5
18 x 35.5	7.5
18 x 40	7.5



Kinked leads (Chapter B)

Available for series B41858, B41859, B41863, B41866, B41868, B41888, B41890, B41896, B42824, B42851, B43866, B43867, B43890, B43896.

Last 3 digits of ordering code: 001

With stand-off rubber seal

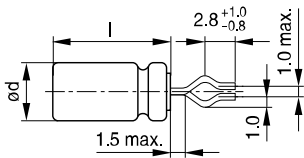

KAL1081-K

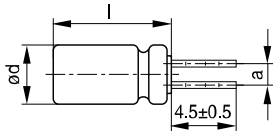

KAL1083-2

With flat rubber seal

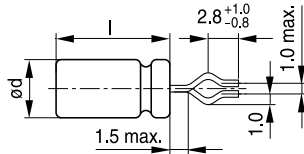

KAL1082-T

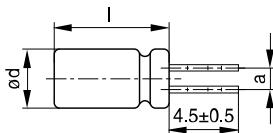

KAL1084-A

Case size d × l (mm)	Dimensions (mm) a ±0.5
10 × 20	5.0
12.5 × 20	5.0
12.5 × 25	5.0
16 × 20	7.5
16 × 25	7.5
16 × 31.5	7.5
16 × 35.5	7.5
18 × 20	7.5
18 × 25	7.5
18 × 31.5	7.5
18 × 35	7.5
18 × 40	7.5



B41890

Extended useful life – 105 °C

PAPR leads (Protection Against Polarity Reversal)

These lead configurations ensure correct placement of the capacitor on the PCB with regard to polarity. PAPR leads are available for diameters from 10 mm up to 18 mm.

There are three configurations available: Crimped leads, J leads, bent 90° leads

Available for series B41858, B41859, B41863, B41866, B41868, B41888, B41890, B41896, B42824, B42851, B43866, B43867, B43890, B43896.

Crimped leads

Last 3 digits of ordering code: 003

With stand-off rubber seal

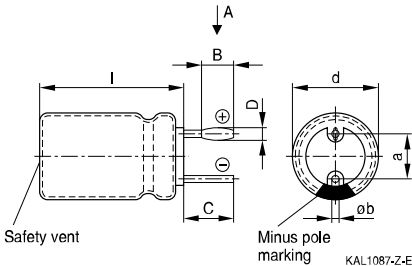

With flat rubber seal

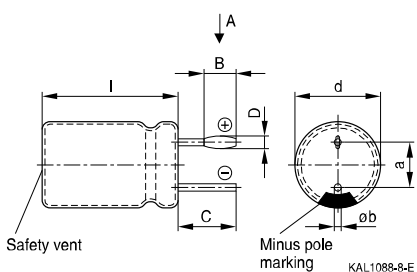

Suggestion for PCB hole diameter

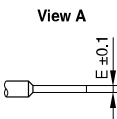

Suggestion for PCB hole diameter, wire ø0.8 mm

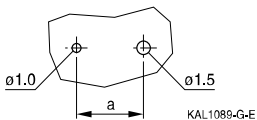

Suggestion for PCB hole diameter, wire ø1.0 mm

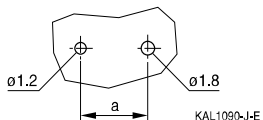

Case size d × l (mm)	Dimensions (mm)					
	B ±0.2	C ±0.5	D ±0.1	E ±0.1	a ±0.5	Øb
16 × 20	1.5	3.0	1.3	0.3	7.5	0.8 ±0.05
16 × 25	1.5	3.0	1.3	0.3	7.5	0.8 ±0.05
16 × 31.5	1.5	3.0	1.3	0.3	7.5	0.8 ±0.05
16 × 35.5	1.5	3.0	1.3	0.3	7.5	0.8 ±0.05
18 × 20	1.5	3.0	1.3	0.3	7.5	0.8 ±0.1
18 × 25	1.5	3.0	1.3	0.3	7.5	0.8 ±0.1
18 × 31.5	1.5	3.0	1.3	0.3	7.5	0.8 ±0.1
18 × 35	1.5	3.0	1.3	0.3	7.5	0.8 ±0.1
18 × 40	1.5	3.0	1.3	0.3	7.5	0.8 ±0.1

J leads

Last 3 digits of ordering code: 004

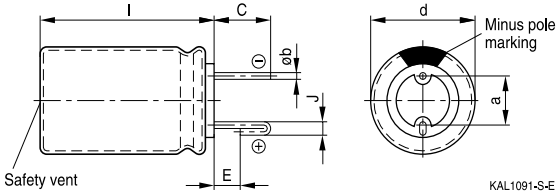
Suggestion for PCB hole diameter

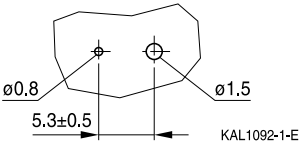
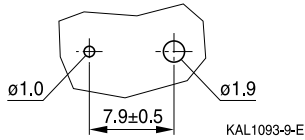
 Suggestion for PCB hole diameter,
wire $\varnothing 0.6$ mm

 Suggestion for PCB hole diameter,
wire $\varnothing 0.8$ mm

Case size $d \times l$ (mm)	Dimensions (mm)				
	$C \pm 0.5$	$E \pm 0.5$	$J \pm 0.2$	$a \pm 0.5$	$\varnothing b$
10 × 12.5	3.2	0.7	1.2	5.0	0.6 ± 0.05
10 × 16	3.2	0.7	1.2	5.0	0.6 ± 0.05
10 × 20	3.2	0.7	1.2	5.0	0.6 ± 0.05
12.5 × 20	3.2	0.7	1.2	5.0	0.6 ± 0.05
12.5 × 25	3.2	0.7	1.2	5.0	0.6 ± 0.05
16 × 20	3.5	0.7	1.6	7.5	0.8 ± 0.05
16 × 25	3.5	0.7	1.6	7.5	0.8 ± 0.05
16 × 31.5	3.5	0.7	1.6	7.5	0.8 ± 0.05
16 × 35.5	3.5	0.7	1.6	7.5	0.8 ± 0.05
18 × 20	3.5	0.7	1.6	7.5	0.8 ± 0.1
18 × 25	3.5	0.7	1.6	7.5	0.8 ± 0.1
18 × 31.5	3.5	0.7	1.6	7.5	0.8 ± 0.1
18 × 35	3.5	0.7	1.6	7.5	0.8 ± 0.1



B41890

Extended useful life – 105 °C

Bent 90° leads for horizontal mounting pinning

Last 3 digits of ordering code: 012

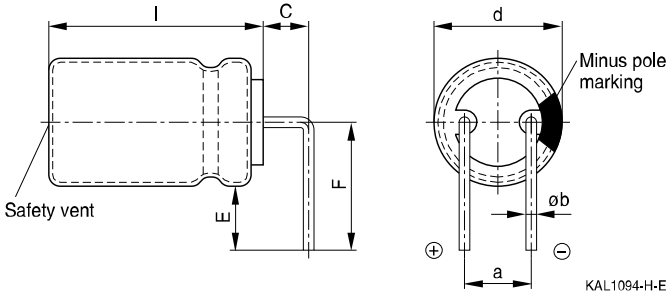

Case size $d \times l$ (mm)	Dimensions (mm)				
	$C \pm 0.5$	$E \pm 0.5$	$F \pm 0.5$	$a \pm 0.5$	$\varnothing b$
16 × 20	4.0	4.0	12.0	7.5	0.8 ±0.05
16 × 25	4.0	4.0	12.0	7.5	0.8 ±0.05
16 × 31.5	4.0	4.0	12.0	7.5	0.8 ±0.05
16 × 35.5	4.0	4.0	12.0	7.5	0.8 ±0.05
18 × 20	4.0	4.0	13.0	7.5	0.8 ±0.1
18 × 25	4.0	4.0	13.0	7.5	0.8 ±0.1
18 × 31.5	4.0	4.0	13.0	7.5	0.8 ±0.1
18 × 35	4.0	4.0	13.0	7.5	0.8 ±0.1
18 × 40	4.0	4.0	13.0	7.5	0.8 ±0.1

Bent leads for diameter 12.5 mm available upon request.



Packing units and box dimensions

Ammo pack

Valid for series B41002, B41022, B41044, B41827, B41828, B43044, B43082, B43086, B43088, B43827, B43828.

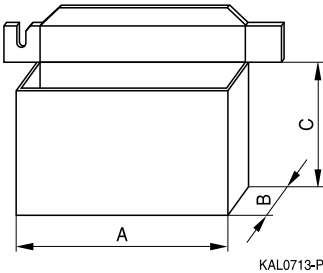

Case size d × l mm	Dimensions (mm)			Packing units pcs.
	A _{max}	B _{max}	C _{max}	
4 × 7	330	50	196	2000
5 × 7	330	50	226	2000
5 × 11	330	50	226	2000
6.3 × 7	330	50	286	2000
6.3 × 11	330	50	286	2000
8 × 7	330	50	246	1000
8 × 11.5	330	50	246	1000
8 × 15	330	50	246	500
10 × 12.5	330	50	196	500
10 × 16	330	54	196	500
10 × 20	330	58	196	500
12.5 × 20	341	60	272	500
12.5 × 25	341	65	272	500
16 × 25	320	65	270	300
16 × 31.5	315	65	275	300
18 × 20	315	65	275	250
18 × 25	315	65	275	250
18 × 31.5	315	65	275	250



B41890

Extended useful life – 105 °C

Ammo pack

Valid for series B41858, B41859, B41863, B41866, B41868, B41888, B41890, B41896, B42824, B42851, B43866, B43867, B43890, B43896.

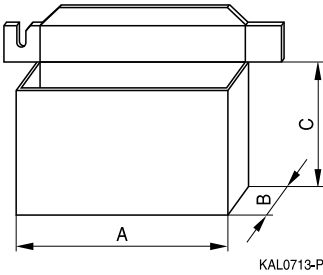

Case size d × l mm	Dimensions (mm)			Packing units pcs.
	A _{max}	B _{max}	C _{max}	
8 × 11.5	345	55	240	1000
10 × 12.5	345	55	280	750
10 × 16	345	60	200	500
10 × 20	345	60	200	500
12.5 × 20	345	65	280	500
12.5 × 25	345	65	280	500
16 × 20	315	65	275	300
16 × 25	315	65	275	300
16 × 31.5	315	65	275	300
18 × 20	315	65	275	250
18 × 25	315	65	275	250
18 × 31.5	315	65	275	250

Overview of packing units and code numbers for case sizes 4 x 7 ... 16 x 40

Valid for series B41002, B41022, B41044, B41827, B41828, B43044, B43082, B43086, B43088, B43827, B43828.

Case size d x l mm	Standard, bulk pcs.	Taped, Ammo pack pcs.	Kinked leads, bulk pcs.	Cut leads, bulk pcs.		
4 x 7	10000	2000	15000	15000		
5 x 7	7500	2000	10000	10000		
5 x 11	5000	2000	10000	10000		
6.3 x 7	5000	2000	10000	10000		
6.3 x 11	5000	2000	5000	5000		
8 x 7	5000	1000	5000	5000		
8 x 11.5	2500	1000	4000	4000		
8 x 15	2000	1000	2500	2500		
8 x 20	1500	–	2000	2000		
10 x 12.5	2000	500	2500	2500		
10 x 16	1500	500	2000	2000		
10 x 20	1000	500	1500	1500		
10 x 25	1000	500	1250	1250		
12.5 x 16	750	500	1000	1000		
12.5 x 20	750	500	500	500		
12.5 x 25	750	500	500	500		
12.5 x 31.5	500	–	750	750		
12.5 x 35.5	500	–	750	750		
12.5 x 40	500	–	750	750		
16 x 20	375	300	500	500		
16 x 25	375	300	500	500		
16 x 31.5	250	300	375	375		
16 x 35.5	250	–	375	375		
16 x 40	250	–	375	375		
The last three digits of the complete ordering code state the lead configuration	000	Code	F (mm)	d (mm)	001	002
		006	3.5	8		
		007	2.5	4 ... 6.3		
		008	5.0	4 ... 12.5		
		009	7.5	16 ... 18		
		016	2.0	4 ... 5		

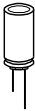
B41890
Extended useful life – 105 °C
Overview of packing units and code numbers for case sizes 18 x 20 ... 18 x 40

Valid for series B41002, B41022, B41044, B41827, B41828, B43044, B43082, B43086, B43088, B43827, B43828.

Case size d x l mm	Standard, bulk pcs.	Taped, Ammo pack pcs.			Kinked leads, bulk pcs.	Cut leads, bulk pcs.
18 x 20	250	250			100	100
18 x 25	250	250			100	100
18 x 31.5	250	250			100	100
18 x 35.5	250	–			100	100
18 x 40	250	–			100	100
The last three digits of the complete ordering code state the lead configuration	000	Code	F (mm)	d (mm)	001	002
		009	7.5	16 ... 18		

Overview of packing units and code numbers for case sizes 8 × 11.5 ... 16 × 35.5

Valid for series B41858, B41859, B41863, B41866, B41868, B41888, B41890, B41896, B42824, B42851, B43866, B43867, B43890, B43896.

					PAPR				
Case size d × l	Stan- dard, bulk	Taped, Ammo pack			Kinked leads, bulk	Cut leads, bulk	Crimped leads, blister	J leads, blister	Bent 90° leads, blister
mm	pcs.	pcs.		pcs.	pcs.	pcs.	pcs.	pcs.	
8 × 11.5	1000	1000		–	–	–	–		
10 × 12.5	1000	750		–	1000	–	675		
10 × 16	1000	500		–	1000	–	675		
10 × 20	500	500		500	500	–	500		
12.5 × 20	350	500		350	350	–	300	1)	
12.5 × 25	250	500		500	500	–	225	1)	
12.5 × 30	200	–		–	–	–	–		
12.5 × 35	175	–		–	–	–	–		
12.5 × 40	175	–		–	–	–	–		
16 × 20	250	300		200	200	200	200	120	
16 × 25	250	300		200	200	200	200	120	
16 × 31.5	200	300		250	250	344	344	120	
16 × 35.5	100	–		100	100	150	150	150	
The last three digits of the complete ordering code state the lead configuration	000	Code	F (mm)	d (mm)	001	002	003	004	012
		006	3.5	8					
		008	5	5...12.5					
		009	7.5	16...18					

1) Available upon request



B41890

Extended useful life – 105 °C

Overview of packing units and code numbers for case sizes 18 × 20 ... 18 × 40

Valid for series B41858, B41859, B41863, B41866, B41868, B41888, B41890, B41896, B42824, B42851, B43866, B43867, B43890, B43896.

					PAPR				
Case size d × l mm	Standard, bulk pcs.	Taped, Ammo pack pcs.			Kinked leads, bulk pcs.	Cut leads, bulk pcs.	Crimped leads, blister pcs.	J leads, blister pcs.	Bent 90° leads, blister pcs.
18 × 20	175	250			175	175	200	200	120
18 × 25	150	250			150	150	200	200	120
18 × 31.5	100	250			100	100	150	150	120
18 × 35	100	–			100	100	150	150	150
18 × 40	125	–			100	100	120	–	72
The last three digits of the complete ordering code state the lead configuration	000	Code	F (mm)	d (mm)	001	002	003	004	012
		009	7.5	16...18					



Cautions and warnings

Personal safety

The electrolytes used by EPCOS have not only been optimized with a view to the intended application, but also with regard to health and environmental compatibility. They do not contain any solvents that are detrimental to health, e.g. dimethyl formamide (DMF) or dimethyl acetamide (DMAC).

Furthermore, part of the high-voltage electrolytes used by EPCOS are self-extinguishing. They contain flame-retarding substances which will quickly extinguish any flame that may have been ignited.

As far as possible, EPCOS does not use any dangerous chemicals or compounds to produce operating electrolytes. However, in exceptional cases, such materials must be used in order to achieve specific physical and electrical properties because no safe substitute materials are currently known. However, the amount of dangerous materials used in our products has been limited to an absolute minimum. Nevertheless, the following rules should be observed when handling aluminum electrolytic capacitors:

- Any escaping electrolyte should not come into contact with eyes or skin.
- If electrolyte does come into contact with the skin, wash the affected parts immediately with running water. If the eyes are affected, rinse them for 10 minutes with plenty of water. If symptoms persist, seek medical treatment.
- Avoid breathing in electrolyte vapor or mists. Workplaces and other affected areas should be well ventilated. Clothing that has been contaminated by electrolyte must be changed and rinsed in water.



Product safety

The table below summarizes the safety instructions that must be observed without fail. A detailed description can be found in the relevant sections of chapter "General technical information".

Topic	Safety information	Reference chapter "General technical information"
Polarity	Make sure that polar capacitors are connected with the right polarity.	1 "Basic construction of aluminum electrolytic capacitors"
Reverse voltage	Voltages polarity classes should be prevented by connecting a diode.	3.1.6 "Reverse voltage"
Upper category temperature	Do not exceed the upper category temperature.	7.2 "Maximum permissible operating temperature"
Maintenance	Make periodic inspections of the capacitors. Before the inspection, make sure that the power supply is turned off and carefully discharge the electricity of the capacitors. Do not apply any mechanical stress to the capacitor terminals.	10 "Maintenance"
Mounting position of screw-terminal capacitors	Do not mount the capacitor with the terminals (safety vent) upside down.	11.1. "Mounting positions of capacitors with screw terminals"
Mounting of single-ended capacitors	The internal structure of single-ended capacitors might be damaged if excessive force is applied to the lead wires. Avoid any compressive, tensile or flexural stress. Do not move the capacitor after soldering to PC board. Do not pick up the PC board by the soldered capacitor. Do not insert the capacitor on the PC board with a hole space different to the lead space specified.	11.4 "Mounting considerations for single-ended capacitors"
Robustness of terminals	The following maximum tightening torques must not be exceeded when connecting screw terminals: M5: 2 Nm M6: 2.5 Nm	11.3 "Mounting torques"
Soldering	Do not exceed the specified time or temperature limits during soldering.	11.5 "Soldering"



Topic	Safety information	Reference chapter "General technical information"
Soldering, cleaning agents	Do not allow halogenated hydrocarbons to come into contact with aluminum electrolytic capacitors.	11.6 "Cleaning agents"
Passive flammability	Avoid external energy, such as fire or electricity.	8.1 "Passive flammability"
Active flammability	Avoid overload of the capacitors.	8.2 "Active flammability"
		Reference chapter "Capacitors with screw terminals"
Breakdown strength of insulating sleeves	Do not damage the insulating sleeve, especially when ring clips are used for mounting.	"Screw terminals – accessories"

B41890
Extended useful life – 105 °C
Symbols and terms

Symbol	English	German
C	Capacitance	Kapazität
C_R	Rated capacitance	Nennkapazität
C_S	Series capacitance	Serienkapazität
$C_{S,T}$	Series capacitance at temperature T	Serienkapazität bei Temperatur T
C_f	Capacitance at frequency f	Kapazität bei Frequenz f
d	Case diameter, nominal dimension	Gehäusedurchmesser, Nennmaß
d_{max}	Maximum case diameter	Maximaler Gehäusedurchmesser
ESL	Self-inductance	Eigeninduktivität
ESR	Equivalent series resistance	Ersatzserienwiderstand
ESR_f	Equivalent series resistance at frequency f	Ersatzserienwiderstand bei Frequenz f
ESR_T	Equivalent series resistance at temperature T	Ersatzserienwiderstand bei Temperatur T
f	Frequency	Frequenz
I	Current	Strom
I_{AC}	Alternating current (ripple current)	Wechselstrom
$I_{AC,rms}$	Root-mean-square value of alternating current	Wechselstrom, Effektivwert
$I_{AC,f}$	Ripple current at frequency f	Wechselstrom bei Frequenz f
$I_{AC,max}$	Maximum permissible ripple current	Maximal zulässiger Wechselstrom
$I_{AC,R}$	Rated ripple current	Nennwechselstrom
$I_{AC,R} (B)$	Rated ripple current for base cooling	Nennwechselstromstrom für Bodenkühlung
I_{leak}	Leakage current	Reststrom
$I_{leak,op}$	Operating leakage current	Betriebsreststrom
l	Case length, nominal dimension	Gehäuselänge, Nennmaß
l_{max}	Maximum case length (without terminals and mounting stud)	Maximale Gehäuselänge (ohne Anschlüsse und Gewindebolzen)
R	Resistance	Widerstand
R_{ins}	Insulation resistance	Isolationswiderstand
R_{symm}	Balancing resistance	Symmetrierwiderstand
T	Temperature	Temperatur
ΔT	Temperature difference	Temperaturdifferenz
T_A	Ambient temperature	Umgebungstemperatur
T_C	Case temperature	Gehäusetemperatur
T_B	Capacitor base temperature	Temperatur des Becherbodens
t	Time	Zeit
Δt	Period	Zeitraum
t_b	Service life (operating hours)	Brauchbarkeitsdauer (Betriebszeit)



Symbol	English	German
V	Voltage	Spannung
V _F	Forming voltage	Formierspannung
V _{op}	Operating voltage	Betriebsspannung
V _R	Rated voltage, DC voltage	Nennspannung, Gleichspannung
V _S	Surge voltage	Spitzenspannung
X _C	Capacitive reactance	Kapazitiver Blindwiderstand
X _L	Inductive reactance	Induktiver Blindwiderstand
Z	Impedance	Scheinwiderstand
Z _T	Impedance at temperature T	Scheinwiderstand bei Temperatur T
tan δ	Dissipation factor	Verlustfaktor
λ	Failure rate	Ausfallrate
ε ₀	Absolute permittivity	Elektrische Feldkonstante
ε _r	Relative permittivity	Dielektrizitätszahl
ω	Angular velocity; 2 · π · f	Kreisfrequenz; 2 · π · f

Note

All dimensions are given in mm.

Important notes

The following applies to all products named in this publication:

1. Some parts of this publication contain **statements about the suitability of our products for certain areas of application**. These statements are based on our knowledge of typical requirements that are often placed on our products in the areas of application concerned. We nevertheless expressly point out **that such statements cannot be regarded as binding statements about the suitability of our products for a particular customer application**. As a rule, EPCOS is either unfamiliar with individual customer applications or less familiar with them than the customers themselves. For these reasons, it is always ultimately incumbent on the customer to check and decide whether an EPCOS product with the properties described in the product specification is suitable for use in a particular customer application.
2. We also point out that **in individual cases, a malfunction of electronic components or failure before the end of their usual service life cannot be completely ruled out in the current state of the art, even if they are operated as specified**. In customer applications requiring a very high level of operational safety and especially in customer applications in which the malfunction or failure of an electronic component could endanger human life or health (e.g. in accident prevention or lifesaving systems), it must therefore be ensured by means of suitable design of the customer application or other action taken by the customer (e.g. installation of protective circuitry or redundancy) that no injury or damage is sustained by third parties in the event of malfunction or failure of an electronic component.
3. **The warnings, cautions and product-specific notes must be observed.**
4. In order to satisfy certain technical requirements, **some of the products described in this publication may contain substances subject to restrictions in certain jurisdictions (e.g. because they are classed as hazardous)**. Useful information on this will be found in our Material Data Sheets on the Internet (www.epcos.com/material). Should you have any more detailed questions, please contact our sales offices.
5. We constantly strive to improve our products. Consequently, **the products described in this publication may change from time to time**. The same is true of the corresponding product specifications. Please check therefore to what extent product descriptions and specifications contained in this publication are still applicable before or when you place an order. We also **reserve the right to discontinue production and delivery of products**. Consequently, we cannot guarantee that all products named in this publication will always be available. The aforementioned does not apply in the case of individual agreements deviating from the foregoing for customer-specific products.
6. Unless otherwise agreed in individual contracts, **all orders are subject to the current version of the "General Terms of Delivery for Products and Services in the Electrical Industry" published by the German Electrical and Electronics Industry Association (ZVEI)**.
7. The trade names EPCOS, BAOKE, Alu-X, CeraDiode, CSMP, CSSP, CTVS, DeltaCap, DigiSiMic, DSSP, FormFit, MiniBlue, MiniCell, MKK, MKD, MLSC, MotorCap, PCC, PhaseCap, PhaseCube, PhaseMod, PhiCap, SIFERRIT, SIFI, SIKOREL, SilverCap, SIMDAD, SiMic, SIMID, SineFormer, SIOV, SIP5D, SIP5K, ThermoFuse, WindCap are **trade-marks registered or pending** in Europe and in other countries. Further information will be found on the Internet at www.epcos.com/trademarks.