



Aluminum electrolytic capacitors

Single-ended capacitors

Series/Type: B41890
Date: December 2010

Long-life grade capacitors for automotive electronics and lighting applications

Applications

- High-reliability equipment in automotive, LED lighting and industrial electronics

Features

- High reliability and long useful life
- High ripple current capability
- Extra long useful life (10000 to 15000 h/105 °C)
- RoHS-compatible

Construction

- Charge-discharge proof, polar
- Aluminum case with insulating sleeve
- Minus pole marking on the insulating sleeve
- Case with safety vent

Delivery mode

Terminal configurations and packing:

- Bulk
- Taped, Ammo pack
- Cut (see chapter "Single-ended – Taping, packing and lead configurations, Cut leads (Chapter B)")
- Kinked (see chapter "Single-ended – Taping, packing and lead configurations, Kinked leads (Chapter B)")
- PAPR (protection against polarity reversal):
crimped leads, J leads, bent leads

Refer to chapter "Single-ended capacitors – Taping, packing and lead configurations" for further details.

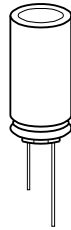

Specifications and characteristics in brief

| | | | | |
|---|---|------------|------|------|
| Rated voltage V_R | 16 ... 50 V DC | | | |
| Surge voltage V_S | $1.15 \cdot V_R$ | | | |
| Rated capacitance C_R | 100 ... 6800 μ F | | | |
| Capacitance tolerance | $\pm 20\% \triangleq M$ | | | |
| Dissipation factor $\tan \delta$ (20 °C, 120 Hz) | For capacitance higher than 1000 μ F add 0.02 for every increase of 1000 μ F. | | | |
| | V_R (V DC) | 16 ... 25 | 35 | 50 |
| | $\tan \delta$ (max.) | 0.17 | 0.12 | 0.10 |
| Leakage current I_{leak} (20 °C, 5 min) | $I_{leak} = 0.01 \mu A \cdot \left(\frac{C_R}{\mu F} \cdot \frac{V_R}{V} \right)$ or 3 μ A, whichever is greater | | | |
| Self-inductance ESL | Diameter (mm) | 8 ... 12.5 | 16 | 18 |
| | ESL (nH) | 20 | 26 | 34 |
| Useful life 105 °C; V_R ; $I_{AC,R}$ | > 10000 h for $\varnothing \leq 10$ mm > 15000 h for $\varnothing \geq 12.5$ mm | | | |
| Requirements | $\Delta C/C \leq \pm 35\%$ of initial value $\tan \delta \leq 3$ times initial specified limit $I_{leak} \leq$ initial specified limit | | | |
| Voltage endurance test 105 °C; V_R | 10000 h for $\varnothing \leq 10$ mm 15000 h for $\varnothing \geq 12.5$ mm | | | |
| Post test requirements | $\Delta C/C \leq \pm 30\%$ of initial value $\tan \delta \leq 2$ times initial specified limit $I_{leak} \leq$ initial specified limit | | | |
| Vibration resistance test | To IEC 60068-2-6, test Fc: Frequency range 10 Hz ... 2 kHz, displacement amplitude max. 1.5 mm, acceleration max. 20 g, duration 3×2 h. Capacitor rigidly clamped by the aluminum case. | | | |
| IEC climatic category | To IEC 60068-1: 55/105/56 (–55 °C/+105 °C/56 days damp heat test) | | | |
| Sectional specification | IEC 60384-4, AEC-Q200 | | | |



B41890

Extended useful life – 105 °C

Dimensional drawing

With stand-off rubber seal

Diameters (mm): 10, 12.5, 16, 18

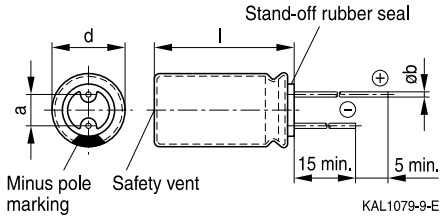

Dimensions and weights

| Dimensions (mm) | | | | Approx. weight |
|-----------------|-----------|--------|------------|----------------|
| d +0.5 | l | a ±0.5 | b | g |
| 10 | 16 +1.0 | 5.0 | 0.60 ±0.05 | 1.9 |
| 10 | 20 +2.0 | 5.0 | 0.60 ±0.05 | 2.6 |
| 12.5 | 20 +2.0 | 5.0 | 0.60 ±0.05 | 3.6 |
| 12.5 | 25 +2.0 | 5.0 | 0.60 ±0.05 | 4.5 |
| 12.5 | 30 +2.0 | 5.0 | 0.80 ±0.05 | 5.3 |
| 12.5 | 40 +2.0 | 5.0 | 0.80 ±0.05 | 7.4 |
| 16 | 20 +2.0 | 7.5 | 0.80 ±0.05 | 5.5 |
| 16 | 25 +2.0 | 7.5 | 0.80 ±0.05 | 7.5 |
| 16 | 31.5 +2.0 | 7.5 | 0.80 ±0.05 | 7.8 |
| 18 | 20 +2.0 | 7.5 | 0.80 ±0.1 | 8.0 |
| 18 | 25 +2.0 | 7.5 | 0.80 ±0.1 | 9.0 |
| 18 | 31.5 +2.0 | 7.5 | 0.80 ±0.1 | 11.0 |
| 18 | 35 +2.0 | 7.5 | 0.80 ±0.1 | 13.0 |
| 18 | 40 +2.0 | 7.5 | 0.80 ±0.1 | 16.0 |

Overview of available types

| V_R (V DC) | 16 | 25 | 35 | 50 |
|------------------|-----------------------------------|---------------------------------|---------------------------------|----------------------|
| | Case dimensions $d \times l$ (mm) | | | |
| C_R (μ F) | | | | |
| 100 | | 10 × 16 | 10 × 16 | 10 × 16 |
| 120 | | 10 × 16 | 10 × 16 | 10 × 16 |
| 150 | | 10 × 16 | 10 × 16 | 10 × 16 |
| 180 | | 10 × 16 | 10 × 16 | 10 × 20 |
| 220 | 10 × 16 | 10 × 16 | 10 × 16 | 10 × 20 |
| 270 | 10 × 16 | 10 × 16 | 10 × 20 | 12.5 × 20 |
| 330 | 10 × 16 | 10 × 16 | 10 × 20 | 12.5 × 20 |
| 390 | 10 × 16 | 10 × 16 | 12.5 × 20 | 12.5 × 25 |
| 470 | 10 × 16 | 10 × 20 | 12.5 × 20 | 12.5 × 25 16 × 20 |
| 560 | 10 × 16 | 10 × 20 | 12.5 × 25 | 16 × 20 |
| 680 | 10 × 16 | 10 × 20 | 12.5 × 25 | 16 × 25 18 × 20 |
| 820 | 10 × 20 | 12.5 × 20 | 16 × 20 | 16 × 31.5 |
| 1000 | 12.5 × 20 | 12.5 × 25 16 × 20 | 12.5 × 40 16 × 25 18 × 20 | 16 × 31.5 |
| 1200 | 12.5 × 20 | 12.5 × 25 | 16 × 25 18 × 20 | 18 × 31.5 |
| 1500 | 12.5 × 25 | 16 × 20 | 16 × 31.5 | 18 × 35 |
| 1800 | 12.5 × 25 | 12.5 × 40 16 × 25 18 × 20 | 18 × 31.5 | 18 × 40 |
| 2200 | 12.5 × 30 16 × 20 | 16 × 31.5 18 × 25 | 18 × 35 | |
| 2700 | 16 × 25 18 × 20 | 16 × 31.5 | 18 × 40 | |
| 3300 | 16 × 31.5 | 18 × 31.5 | | |
| 3900 | 16 × 31.5 | 18 × 35 | | |
| 4700 | 18 × 31.5 | 18 × 40 | | |
| 5600 | 18 × 35 | | | |
| 6800 | 18 × 40 | | | |

Other voltage and capacitance ratings are available upon request.

Technical data and ordering codes

| C_R | Case dimensions | ESR_{max} 10 kHz –40 °C | ESR_{max} 10 kHz 20 °C | Z_{max} 100 kHz 20 °C | $I_{AC,R}$ 100 kHz 105 °C | Ordering code (composition see below) |
|-----------------------------------|--------------------|---------------------------------|--------------------------------|-------------------------------|---------------------------------|--|
| 120 Hz 20 °C μF | $d \times l$ mm | Ω | Ω | Ω | mA | |
| $V_R = 16 V DC$ | | | | | | |
| 220 | 10 × 16 | 1.104 | 0.138 | 0.115 | 965 | B41890A4227M*** |
| 270 | 10 × 16 | 1.104 | 0.138 | 0.115 | 965 | B41890A4277M*** |
| 330 | 10 × 16 | 1.104 | 0.138 | 0.115 | 965 | B41890A4337M*** |
| 390 | 10 × 16 | 1.104 | 0.138 | 0.115 | 965 | B41890A4397M*** |
| 470 | 10 × 16 | 1.104 | 0.138 | 0.115 | 965 | B41890A4477M*** |
| 560 | 10 × 16 | 1.104 | 0.138 | 0.115 | 965 | B41890A4567M*** |
| 680 | 10 × 16 | 1.104 | 0.138 | 0.115 | 965 | B41890A4687M*** |
| 820 | 10 × 20 | 0.595 | 0.074 | 0.062 | 1205 | B41890A4827M*** |
| 1000 | 12.5 × 20 | 0.528 | 0.066 | 0.055 | 1820 | B41890A4108M*** |
| 1200 | 12.5 × 20 | 0.528 | 0.066 | 0.055 | 1820 | B41890A4128M*** |
| 1500 | 12.5 × 25 | 0.365 | 0.046 | 0.038 | 2280 | B41890A4158M*** |
| 1800 | 12.5 × 25 | 0.365 | 0.046 | 0.038 | 2280 | B41890A4188M*** |
| 2200 | 12.5 × 30 | 0.298 | 0.037 | 0.031 | 2860 | B41890A4228M*** |
| 2200 | 16 × 20 | 0.365 | 0.046 | 0.038 | 2280 | B41890B4228M*** |
| 2700 | 16 × 25 | 0.288 | 0.036 | 0.030 | 2860 | B41890A4278M*** |
| 2700 | 18 × 20 | 0.336 | 0.042 | 0.035 | 2490 | B41890B4278M*** |
| 3300 | 16 × 31.5 | 0.240 | 0.030 | 0.025 | 3160 | B41890A4338M*** |
| 3900 | 16 × 31.5 | 0.240 | 0.030 | 0.025 | 3160 | B41890A4398M*** |
| 4700 | 18 × 31.5 | 0.230 | 0.029 | 0.024 | 3500 | B41890A4478M*** |
| 5600 | 18 × 35 | 0.211 | 0.026 | 0.022 | 3840 | B41890A4568M*** |
| 6800 | 18 × 40 | 0.173 | 0.022 | 0.018 | 4230 | B41890A4688M*** |

Composition of ordering code

*** = Version

000 = for standard leads, bulk

 001 = for kinked leads, bulk (for $d \times l = 10 \times 20 \dots 12.5 \times 25$ mm and $\varnothing 16 \dots 18$ mm)

 002 = for cut leads, bulk (for $\varnothing 10 \dots 18$ mm, excluding $d \times l = 12.5 \times 30/40$ mm)

 003 = for crimped leads, blister (for $\varnothing 16 \dots 18$ mm)

 004 = for J leads, blister (for $\varnothing 10 \dots 18$ mm, excluding $d \times l = 12.5 \times 30/40$ and 18×40 mm)

 008 = for taped leads, Ammo pack, lead spacing $F = 5.0$ mm (for $d \times l = 10 \times 16 \dots 12.5 \times 25$ mm)

 009 = for taped leads, Ammo pack, lead spacing $F = 7.5$ mm (for $\varnothing 16$ mm and $d \times l = 18 \times 20 \dots 18 \times 31.5$ mm)

 012 = for bent 90° leads, blister (for $\varnothing 16 \dots 18$ mm)

Technical data and ordering codes

| C_R | Case dimensions | ESR_{max} 10 kHz -40 °C | ESR_{max} 10 kHz 20 °C | Z_{max} 100 kHz 20 °C | $I_{AC,R}$ 100 kHz 105 °C | Ordering code (composition see below) |
|-----------------------------------|-----------------|---------------------------------|--------------------------------|-------------------------------|---------------------------------|--|
| μF | d × l mm | Ω | Ω | Ω | mA | |
| $V_R = 25 V DC$ | | | | | | |
| 100 | 10 × 16 | 1.104 | 0.138 | 0.115 | 965 | B41890A5107M*** |
| 120 | 10 × 16 | 1.104 | 0.138 | 0.115 | 965 | B41890A5127M*** |
| 150 | 10 × 16 | 1.104 | 0.138 | 0.115 | 965 | B41890A5157M*** |
| 180 | 10 × 16 | 1.104 | 0.138 | 0.115 | 965 | B41890A5187M*** |
| 220 | 10 × 16 | 1.104 | 0.138 | 0.115 | 965 | B41890A5227M*** |
| 270 | 10 × 16 | 1.104 | 0.138 | 0.115 | 965 | B41890A5277M*** |
| 330 | 10 × 16 | 1.104 | 0.138 | 0.115 | 965 | B41890A5337M*** |
| 390 | 10 × 16 | 1.104 | 0.138 | 0.115 | 965 | B41890A5397M*** |
| 470 | 10 × 20 | 0.595 | 0.074 | 0.062 | 1205 | B41890A5477M*** |
| 560 | 10 × 20 | 0.595 | 0.074 | 0.062 | 1205 | B41890A5567M*** |
| 680 | 10 × 20 | 0.595 | 0.074 | 0.062 | 1205 | B41890A5687M*** |
| 820 | 12.5 × 20 | 0.528 | 0.066 | 0.055 | 1820 | B41890A5827M*** |
| 1000 | 12.5 × 25 | 0.365 | 0.046 | 0.038 | 2280 | B41890A5108M*** |
| 1000 | 16 × 20 | 0.365 | 0.046 | 0.038 | 2280 | B41890B5108M*** |
| 1200 | 12.5 × 25 | 0.365 | 0.046 | 0.038 | 2280 | B41890A5128M*** |
| 1500 | 16 × 20 | 0.365 | 0.046 | 0.038 | 2280 | B41890A5158M*** |
| 1800 | 12.5 × 40 | 0.250 | 0.031 | 0.026 | 3340 | B41890A5188M*** |
| 1800 | 16 × 25 | 0.288 | 0.036 | 0.030 | 2860 | B41890B5188M*** |
| 1800 | 18 × 20 | 0.336 | 0.042 | 0.035 | 2490 | B41890C5188M*** |
| 2200 | 16 × 31.5 | 0.240 | 0.030 | 0.025 | 3160 | B41890A5228M*** |
| 2200 | 18 × 25 | 0.269 | 0.034 | 0.028 | 3010 | B41890B5228M*** |
| 2700 | 16 × 31.5 | 0.240 | 0.030 | 0.025 | 3160 | B41890A5278M*** |
| 3300 | 18 × 31.5 | 0.230 | 0.029 | 0.024 | 3500 | B41890A5338M*** |
| 3900 | 18 × 35 | 0.211 | 0.026 | 0.022 | 3840 | B41890A5398M*** |
| 4700 | 18 × 40 | 0.173 | 0.022 | 0.018 | 4230 | B41890A5478M*** |

Composition of ordering code

*** = Version

- 000 = for standard leads, bulk
- 001 = for kinked leads, bulk (for d × l = 10 × 20 ... 12.5 × 25 mm and \varnothing 16 ... 18 mm)
- 002 = for cut leads, bulk (for \varnothing 10 ... 18 mm, excluding d × l = 12.5 × 30/40 mm)
- 003 = for crimped leads, blister (for \varnothing 16 ... 18 mm)
- 004 = for J leads, blister (for \varnothing 10 ... 18 mm, excluding d × l = 12.5 × 30/40 and 18 × 40 mm)
- 008 = for taped leads, Ammo pack, lead spacing F = 5.0 mm (for d × l = 10 × 16 ... 12.5 × 25 mm)
- 009 = for taped leads, Ammo pack, lead spacing F = 7.5 mm (for \varnothing 16 mm and d × l = 18 × 20 ... 18 × 31.5 mm)
- 012 = for bent 90° leads, blister (for \varnothing 16 ... 18 mm)

B41890
Extended useful life – 105 °C
Technical data and ordering codes

| C_R | Case dimensions | ESR_{max} | ESR_{max} | Z_{max} | $I_{AC,R}$ | Ordering code (composition see below) |
|-----------------------------------|--------------------|------------------------------|-----------------------------|------------------------------|-------------------------|--|
| 120 Hz 20 °C μF | $d \times l$ mm | 10 kHz –40 °C Ω | 10 kHz 20 °C Ω | 100 kHz 20 °C Ω | 100 kHz 105 °C mA | |
| $V_R = 35 V DC$ | | | | | | |
| 100 | 10 × 16 | 1.104 | 0.138 | 0.115 | 965 | B41890A7107M*** |
| 120 | 10 × 16 | 1.104 | 0.138 | 0.115 | 965 | B41890A7127M*** |
| 150 | 10 × 16 | 1.104 | 0.138 | 0.115 | 965 | B41890A7157M*** |
| 180 | 10 × 16 | 1.104 | 0.138 | 0.115 | 965 | B41890A7187M*** |
| 220 | 10 × 16 | 1.104 | 0.138 | 0.115 | 965 | B41890A7227M*** |
| 270 | 10 × 20 | 0.595 | 0.074 | 0.062 | 1205 | B41890A7277M*** |
| 330 | 10 × 20 | 0.595 | 0.074 | 0.062 | 1205 | B41890A7337M*** |
| 390 | 12.5 × 20 | 0.528 | 0.066 | 0.055 | 1820 | B41890A7397M*** |
| 470 | 12.5 × 20 | 0.528 | 0.066 | 0.055 | 1820 | B41890A7477M*** |
| 560 | 12.5 × 25 | 0.365 | 0.046 | 0.038 | 2280 | B41890A7567M*** |
| 680 | 12.5 × 25 | 0.365 | 0.046 | 0.038 | 2280 | B41890A7687M*** |
| 820 | 16 × 20 | 0.365 | 0.046 | 0.038 | 2280 | B41890A7827M*** |
| 1000 | 12.5 × 40 | 0.250 | 0.031 | 0.026 | 3340 | B41890A7108M*** |
| 1000 | 16 × 25 | 0.288 | 0.036 | 0.030 | 2860 | B41890B7108M*** |
| 1000 | 18 × 20 | 0.336 | 0.042 | 0.035 | 2490 | B41890C7108M*** |
| 1200 | 16 × 25 | 0.288 | 0.036 | 0.030 | 2860 | B41890A7128M*** |
| 1200 | 18 × 20 | 0.336 | 0.042 | 0.035 | 2490 | B41890B7128M*** |
| 1500 | 16 × 31.5 | 0.240 | 0.030 | 0.025 | 3160 | B41890A7158M*** |
| 1800 | 18 × 31.5 | 0.230 | 0.029 | 0.024 | 3500 | B41890A7188M*** |
| 2200 | 18 × 35 | 0.211 | 0.026 | 0.022 | 3840 | B41890A7228M*** |
| 2700 | 18 × 40 | 0.173 | 0.022 | 0.018 | 4230 | B41890A7278M*** |

Composition of ordering code

*** = Version

000 = for standard leads, bulk

 001 = for kinked leads, bulk (for $d \times l = 10 \times 20 \dots 12.5 \times 25$ mm and $\varnothing 16 \dots 18$ mm)

 002 = for cut leads, bulk (for $\varnothing 10 \dots 18$ mm, excluding $d \times l = 12.5 \times 30/40$ mm)

 003 = for crimped leads, blister (for $\varnothing 16 \dots 18$ mm)

 004 = for J leads, blister (for $\varnothing 10 \dots 18$ mm, excluding $d \times l = 12.5 \times 30/40$ and 18×40 mm)

 008 = for taped leads, Ammo pack, lead spacing $F = 5.0$ mm (for $d \times l = 10 \times 16 \dots 12.5 \times 25$ mm)

 009 = for taped leads, Ammo pack, lead spacing $F = 7.5$ mm (for $\varnothing 16$ mm and $d \times l = 18 \times 20 \dots$
 18×31.5 mm)

 012 = for bent 90° leads, blister (for $\varnothing 16 \dots 18$ mm)

Technical data and ordering codes

| C_R | Case dimensions | ESR_{max} | ESR_{max} | Z_{max} | $I_{AC,R}$ | Ordering code (composition see below) |
|-----------------------------------|-----------------|-------------|-------------|-----------|------------|--|
| 120 Hz | $d \times l$ | 10 kHz | 10 kHz | 100 kHz | 100 kHz | |
| 20 °C | mm | -40 °C | 20 °C | 20 °C | 105 °C | |
| μF | | Ω | Ω | Ω | mA | |
| $V_R = 50$ V DC | | | | | | |
| 100 | 10 × 16 | 1.248 | 0.156 | 0.130 | 965 | B41890A6107M*** |
| 120 | 10 × 16 | 1.248 | 0.156 | 0.130 | 965 | B41890A6127M*** |
| 150 | 10 × 16 | 1.248 | 0.156 | 0.130 | 965 | B41890A6157M*** |
| 180 | 10 × 20 | 0.672 | 0.084 | 0.070 | 1205 | B41890A6187M*** |
| 220 | 10 × 20 | 0.672 | 0.084 | 0.070 | 1205 | B41890A6227M*** |
| 270 | 12.5 × 20 | 0.576 | 0.072 | 0.060 | 1820 | B41890A6277M*** |
| 330 | 12.5 × 20 | 0.576 | 0.072 | 0.060 | 1820 | B41890A6337M*** |
| 390 | 12.5 × 25 | 0.413 | 0.052 | 0.043 | 2280 | B41890A6397M*** |
| 470 | 12.5 × 25 | 0.413 | 0.050 | 0.043 | 2280 | B41890A6477M*** |
| 470 | 16 × 20 | 0.403 | 0.052 | 0.042 | 2280 | B41890B6477M*** |
| 560 | 16 × 20 | 0.403 | 0.050 | 0.042 | 2280 | B41890A6567M*** |
| 680 | 16 × 25 | 0.326 | 0.041 | 0.034 | 2860 | B41890A6687M*** |
| 680 | 18 × 20 | 0.365 | 0.046 | 0.038 | 2490 | B41890B6687M*** |
| 820 | 16 × 31.5 | 0.269 | 0.034 | 0.028 | 3160 | B41890A6827M*** |
| 1000 | 16 × 31.5 | 0.269 | 0.034 | 0.028 | 3160 | B41890A6108M*** |
| 1200 | 18 × 31.5 | 0.259 | 0.032 | 0.027 | 3500 | B41890A6128M*** |
| 1500 | 18 × 35 | 0.240 | 0.030 | 0.025 | 3840 | B41890A6158M*** |
| 1800 | 18 × 40 | 0.192 | 0.024 | 0.020 | 4230 | B41890A6188M*** |

Composition of ordering code

*** = Version

000 = for standard leads, bulk

 001 = for kinked leads, bulk (for $d \times l = 10 \times 20 \dots 12.5 \times 25$ mm and $\varnothing 16 \dots 18$ mm)

 002 = for cut leads, bulk (for $\varnothing 10 \dots 18$ mm, excluding $d \times l = 12.5 \times 30/40$ mm)

 003 = for crimped leads, blister (for $\varnothing 16 \dots 18$ mm)

 004 = for J leads, blister (for $\varnothing 10 \dots 18$ mm, excluding $d \times l = 12.5 \times 30/40$ and 18×40 mm)

 008 = for taped leads, Ammo pack, lead spacing $F = 5.0$ mm (for $d \times l = 10 \times 16 \dots 12.5 \times 25$ mm)

 009 = for taped leads, Ammo pack, lead spacing $F = 7.5$ mm (for $\varnothing 16$ mm and $d \times l = 18 \times 20 \dots 18 \times 31.5$ mm)

 012 = for bent 90° leads, blister (for $\varnothing 16 \dots 18$ mm)



B41890

Extended useful life – 105 °C

Useful life

depending on ambient temperature T_A under ripple current operating conditions¹⁾

$d = 10 \text{ mm}$

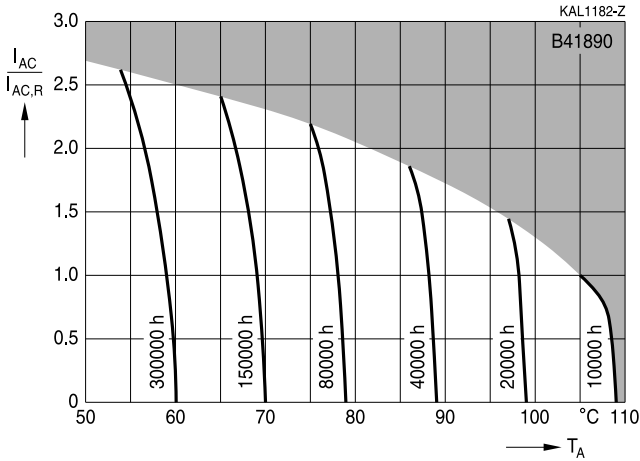

Useful life

depending on ambient temperature T_A under ripple current operating conditions¹⁾

$d \geq 12.5 \text{ mm}$

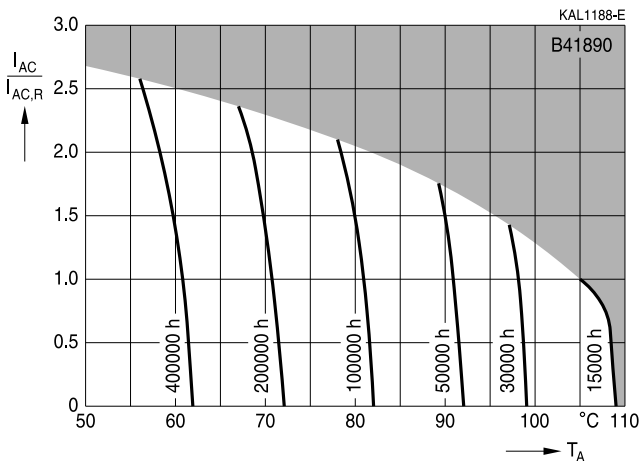

1) Refer to chapter "General technical information, 5.3 Calculation of useful life" for an explanation on how to interpret the useful life graphs.



Frequency factor of permissible ripple current I_{AC} versus frequency f

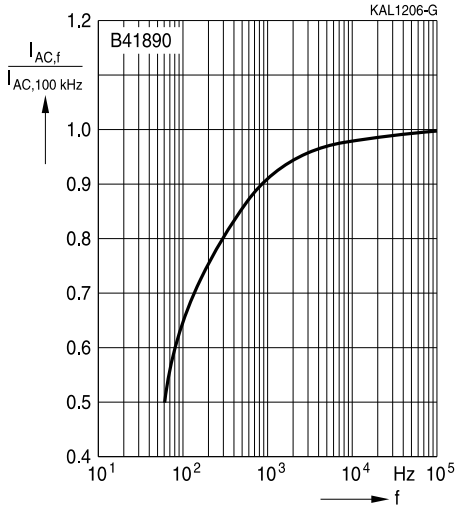



B41890

Extended useful life – 105 °C

Taping, packing and lead configurations

Taping

Single-ended capacitors are available taped in Ammo pack from diameter 4 to 18 mm as follows:

Lead spacing $F = 2.0$ mm ($\varnothing d = 4 \dots 5$ mm)

Lead spacing $F = 2.5$ mm ($\varnothing d = 4 \dots 6.3$ mm)

Lead spacing $F = 3.5$ mm ($\varnothing d = 8$ mm)

Lead spacing $F = 5.0$ mm ($\varnothing d = 4 \dots 12.5$ mm)

Lead spacing $F = 7.5$ mm ($\varnothing d = 16 \dots 18$ mm).

Lead spacing 2.0 mm ($\varnothing d = 4 \dots 5$ mm)

Last 3 digits of ordering code: 016

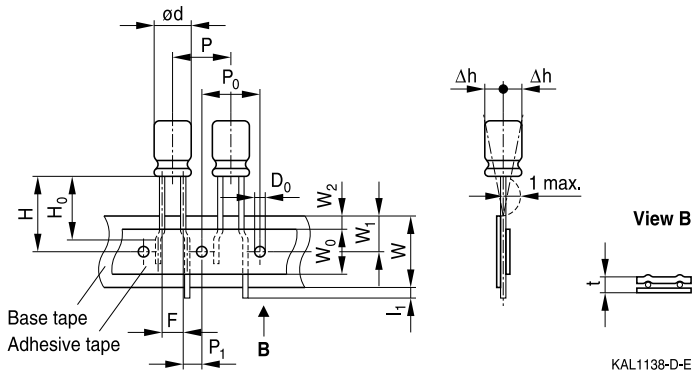

Dimensions in mm

| $\varnothing d$ | F | H | W | W_0 | W_1 | W_2 | P | P_0 | P_1 | l_1 | t | Δh | D_0 |
|-----------------|--------------|-------|------|-------|-------|-------|------|-------|-------|-------|------|------------|-------|
| 4 ... 5 | 2.0 | 18.5 | 18.0 | 7.0 | 9.0 | 3.0 | 12.7 | 12.7 | 5.10 | 1.0 | 0.7 | 1 | 4.0 |
| | +0.8 -0.2 | ±0.75 | ±0.5 | min. | ±0.5 | max. | ±1.0 | ±0.3 | ±0.7 | max. | ±0.2 | ±1.0 | ±0.2 |

Lead spacing 2.5 mm (∅ d = 4 ... 6.3 mm)

Last 3 digits of ordering code: 007

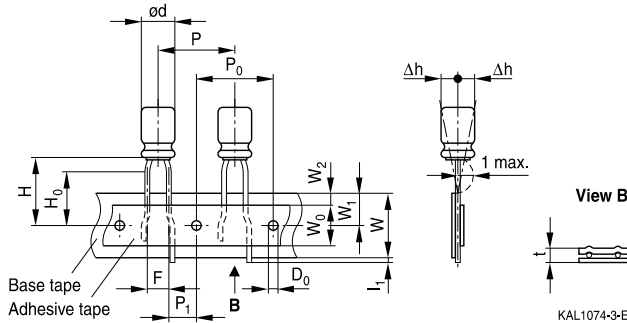
Dimensions in mm

| ∅ d | F | H | W | W ₀ | W ₁ | W ₂ | H ₀ | P | P ₀ | P ₁ | l ₁ | t | ∆h | D ₀ |
|-----------|--------------|-------|------|----------------|----------------|----------------|----------------|------|----------------|----------------|----------------|------|------|----------------|
| 4 ... 6.3 | 2.5 | 18.5 | 18.0 | 5.5 | 9.0 | 1.5 | 16.0 | 12.7 | 12.7 | 5.1 | 1.0 | 0.7 | 1.0 | 4.0 |
| Tolerance | +0.8 -0.2 | ±0.75 | ±0.5 | min. | ±0.5 | max. | ±0.5 | ±1.0 | ±0.2 | ±0.5 | max. | ±0.2 | max. | ±0.2 |

Lead spacing 3.5 mm (∅ d = 8 mm)

Last 3 digits of ordering code: 006

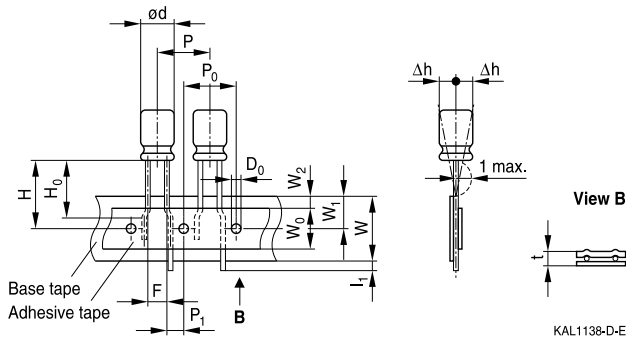
Dimensions in mm

| ∅ d | F | H | W | W ₀ | W ₁ | W ₂ | P | P ₀ | P ₁ | l ₁ | t | ∆h | D ₀ |
|-----------|--------------|------|------|----------------|----------------|----------------|------|----------------|----------------|----------------|------|------|----------------|
| 8 | 3.5 | 18.5 | 18.0 | 10 | 9.0 | 3.0 | 12.7 | 12.7 | 4.6 | 1.0 | 0.7 | 1.0 | 4.0 |
| Tolerance | +0.8 -0.2 | ±1.0 | ±0.5 | min. | ±0.5 | max. | ±1.0 | ±0.3 | ±0.6 | max. | ±0.2 | max. | ±0.2 |

Leads can also run straight through the taping area. Taping is available up to dimensions $d \times l = 8 \times 15$ mm.



B41890

Extended useful life – 105 °C

Lead spacing 5.0 mm (∅ d = 4 ... 8 mm)

Last 3 digits of ordering code: 008

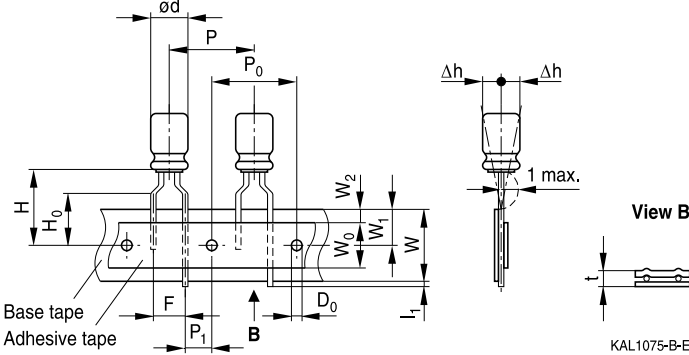

Lead spacing 5.0 mm (∅ d = 10 ... 12.5 mm)

Last 3 digits of ordering code: 008

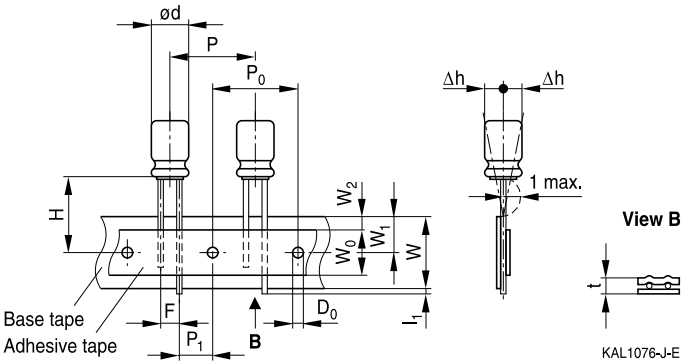

Dimensions in mm

| ∅ d | F | H | W | W ₀ | W ₁ | W ₂ | H ₀ | P | P ₀ | P ₁ | l ₁ | t | Δh | D ₀ |
|-----------|--------------|-------|------|----------------|----------------|----------------|----------------|------|----------------|----------------|----------------|--------------|------|----------------|
| 4 ... 6.3 | 5.0 | 18.5 | 18.0 | 5.5 | 9.0 | 1.5 | 16.0 | 12.7 | 12.7 | 3.85 | 1.0 | 0.6 | 1.0 | 4.0 |
| 8 | 5.0 | 20.0 | 18.0 | 10.0 | 9.0 | 1.5 | 16.0 | 12.7 | 12.7 | 3.85 | 1.0 | 0.6 | 1.0 | 4.0 |
| | | 19.0 | | 12.5 | | | 12.7 | 3.85 | | | | | | |
| 10 | 5.0 | 19.0 | 18.0 | 12.5 | 9.0 | 1.5 | – | 12.7 | 12.7 | 3.85 | 1.0 | 0.6 | 1.0 | 4.0 |
| 12.5 | 19.0 | 12.5 | | – | | | 15.0 | 15.0 | 5.0 | | | | | |
| Tolerance | +0.8 –0.2 | ±0.75 | ±0.5 | min. | ±0.5 | max. | ±0.5 | ±1.0 | ±0.2 | ±0.5 | max. | +0.3 –0.2 | max. | ±0.2 |

Taping is available up to dimensions d × l = 10 × 31.5 mm and 12.5 × 25 mm.

Taping is not available for d × l = 8 × 20 mm.

Lead spacing 7.5 mm (∅ d = 16 ...18 mm)

Last 3 digits of ordering code: 009

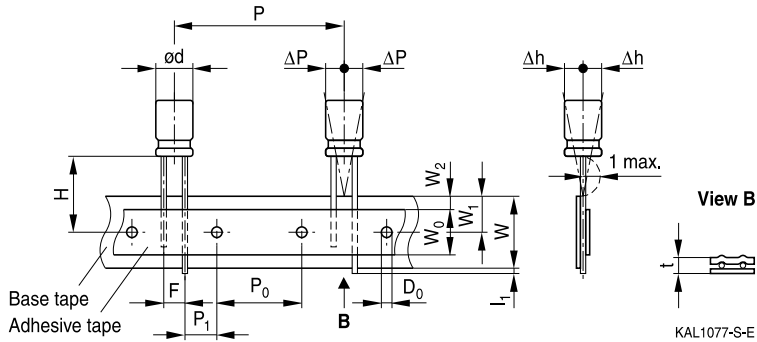
Dimensions in mm

| ∅ d | F | H | W | W ₀ | W ₁ | W ₂ | P | P ₀ | P ₁ | I ₁ | t | ΔP | Δh | D ₀ |
|-----------|------|---------------|------|----------------|----------------|----------------|------|----------------|----------------|----------------|------|------|------|----------------|
| 16 | 7.5 | 18.5 | 18.0 | 12.5 | 9.0 | 1.5 | 30.0 | 15.0 | 3.75 | 1.0 | 0.7 | 0 | 0 | 4.0 |
| 18 | | | | | | | | | | | | | | |
| Tolerance | ±0.8 | -0.5 +0.75 | ±0.5 | min. | ±0.5 | max. | ±1.0 | ±0.2 | ±0.5 | max. | ±0.2 | ±1.0 | ±1.0 | ±0.2 |

Taping is available up to dimensions d × l = 16 × 31.5 mm and 18 × 31.5 mm.



B41890

Extended useful life – 105 °C

Cut or kinked leads

Single-ended capacitors are available with cut or kinked leads. Other lead configurations also available upon request.

Cut leads (Chapter A)

Available for series B41002, B41022, B41044, B41827, B41828, B43044, B43082, B43086, B43088, B43827, B43828.

Last 3 digits of ordering code: 002

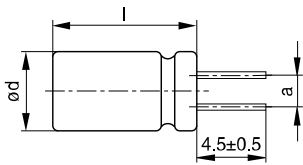

KAL1086-R

| Case size d x l (mm) | Dimensions (mm) a ±0.5 |
|----------------------|---------------------------|
| 4 x 7 | 1.5 |
| 5 x 7 | 2.0 |
| 5 x 11 | 2.0 |
| 6.3 x 7 | 2.5 |
| 6.3 x 11 | 2.5 |
| 8 x 7 | 3.5 |
| 8 x 11.5 | 3.5 |
| 8 x 15 | 3.5 |
| 8 x 20 | 3.5 |
| 10 x 12.5 | 5.0 |
| 10 x 16 | 5.0 |
| 10 x 20 | 5.0 |
| 10 x 25 | 5.0 |
| 10 x 31.5 | 5.0 |

| Case size d x l (mm) | Dimensions (mm) a ±0.5 |
|----------------------|---------------------------|
| 12.5 x 16 | 5.0 |
| 12.5 x 20 | 5.0 |
| 12.5 x 25 | 5.0 |
| 12.5 x 31.5 | 5.0 |
| 12.5 x 35.5 | 5.0 |
| 12.5 x 40 | 5.0 |
| 16 x 20 | 7.5 |
| 16 x 25 | 7.5 |
| 16 x 31.5 | 7.5 |
| 16 x 35.5 | 7.5 |
| 16 x 40 | 7.5 |
| 18 x 20 | 7.5 |
| 18 x 25 | 7.5 |
| 18 x 31.5 | 7.5 |
| 18 x 35.5 | 7.5 |
| 18 x 40 | 7.5 |



Cut leads (Chapter B)

Available for series B41858, B41859, B41863, B41866, B41868, B41888, B41890, B41896, B42824, B42851, B43866, B43867, B43890, B43896.

Last 3 digits of ordering code: 002

With stand-off rubber seal

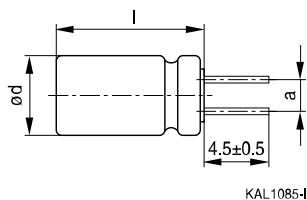

With flat rubber seal

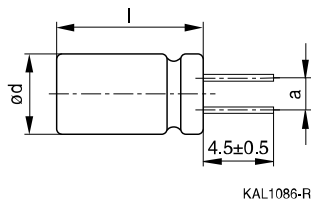

| Case size $d \times l$ (mm) | Dimensions (mm) $a \pm 0.5$ |
|--------------------------------|--------------------------------|
| 10 × 12.5 | 5.0 |
| 10 × 16 | 5.0 |
| 10 × 20 | 5.0 |
| 12.5 × 20 | 5.0 |
| 12.5 × 25 | 5.0 |
| 16 × 20 | 7.5 |
| 16 × 25 | 7.5 |
| 16 × 31.5 | 7.5 |
| 16 × 35.5 | 7.5 |
| 18 × 20 | 7.5 |
| 18 × 25 | 7.5 |
| 18 × 31.5 | 7.5 |
| 18 × 35 | 7.5 |
| 18 × 40 | 7.5 |



B41890

Extended useful life – 105 °C

Kinked leads (Chapter A)

Available for series B41002, B41022, B41044, B41827, B41828, B43044, B43082, B43086, B43088, B43827, B43828.

Last 3 digits of ordering code: 001

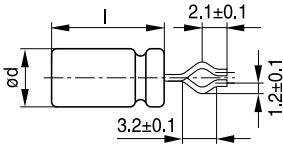

KAL1137-5

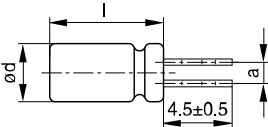

KAL1084-A

| Case size d x l (mm) | Dimensions (mm) a ±0.5 |
|----------------------|---------------------------|
| 4 x 7 | 1.5 |
| 5 x 7 | 2.0 |
| 5 x 11 | 2.0 |
| 6.3 x 7 | 2.5 |
| 6.3 x 11 | 2.5 |
| 8 x 7 | 3.5 |
| 8 x 11.5 | 3.5 |
| 8 x 15 | 3.5 |
| 8 x 20 | 3.5 |
| 10 x 12.5 | 5.0 |
| 10 x 16 | 5.0 |
| 10 x 20 | 5.0 |
| 10 x 25 | 5.0 |
| 10 x 31.5 | 5.0 |

| Case size d x l (mm) | Dimensions (mm) a ±0.5 |
|----------------------|---------------------------|
| 12.5 x 16 | 5.0 |
| 12.5 x 20 | 5.0 |
| 12.5 x 25 | 5.0 |
| 12.5 x 31.5 | 5.0 |
| 12.5 x 35.5 | 5.0 |
| 12.5 x 40 | 5.0 |
| 16 x 20 | 7.5 |
| 16 x 25 | 7.5 |
| 16 x 31.5 | 7.5 |
| 16 x 35.5 | 7.5 |
| 16 x 40 | 7.5 |
| 18 x 20 | 7.5 |
| 18 x 25 | 7.5 |
| 18 x 31.5 | 7.5 |
| 18 x 35.5 | 7.5 |
| 18 x 40 | 7.5 |



Kinked leads (Chapter B)

Available for series B41858, B41859, B41863, B41866, B41868, B41888, B41890, B41896, B42824, B42851, B43866, B43867, B43890, B43896.

Last 3 digits of ordering code: 001

With stand-off rubber seal

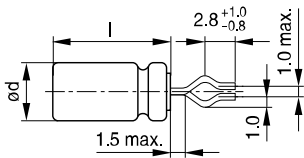

KAL1081-K

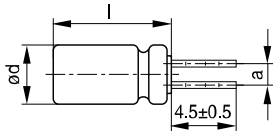

KAL1083-2

With flat rubber seal

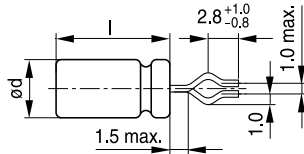

KAL1082-T

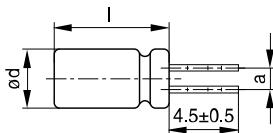

KAL1084-A

| Case size d × l (mm) | Dimensions (mm) a ±0.5 |
|-------------------------|---------------------------|
| 10 × 20 | 5.0 |
| 12.5 × 20 | 5.0 |
| 12.5 × 25 | 5.0 |
| 16 × 20 | 7.5 |
| 16 × 25 | 7.5 |
| 16 × 31.5 | 7.5 |
| 16 × 35.5 | 7.5 |
| 18 × 20 | 7.5 |
| 18 × 25 | 7.5 |
| 18 × 31.5 | 7.5 |
| 18 × 35 | 7.5 |
| 18 × 40 | 7.5 |



B41890

Extended useful life – 105 °C

PAPR leads (Protection Against Polarity Reversal)

These lead configurations ensure correct placement of the capacitor on the PCB with regard to polarity. PAPR leads are available for diameters from 10 mm up to 18 mm.

There are three configurations available: Crimped leads, J leads, bent 90° leads

Available for series B41858, B41859, B41863, B41866, B41868, B41888, B41890, B41896, B42824, B42851, B43866, B43867, B43890, B43896.

Crimped leads

Last 3 digits of ordering code: 003

With stand-off rubber seal

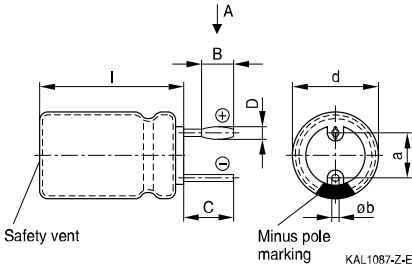

With flat rubber seal

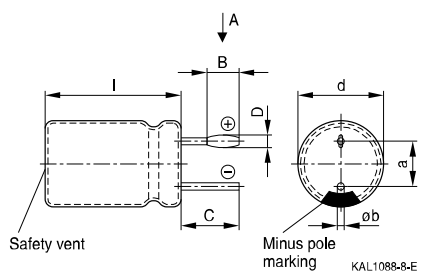

Suggestion for PCB hole diameter

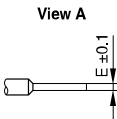

Suggestion for PCB hole diameter, wire ø0.8 mm

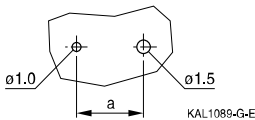

Suggestion for PCB hole diameter, wire ø1.0 mm

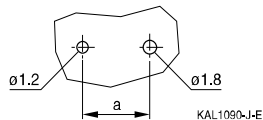

| Case size d × l (mm) | Dimensions (mm) | | | | | |
|-------------------------|-----------------|--------|--------|--------|--------|-----------|
| | B ±0.2 | C ±0.5 | D ±0.1 | E ±0.1 | a ±0.5 | Øb |
| 16 × 20 | 1.5 | 3.0 | 1.3 | 0.3 | 7.5 | 0.8 ±0.05 |
| 16 × 25 | 1.5 | 3.0 | 1.3 | 0.3 | 7.5 | 0.8 ±0.05 |
| 16 × 31.5 | 1.5 | 3.0 | 1.3 | 0.3 | 7.5 | 0.8 ±0.05 |
| 16 × 35.5 | 1.5 | 3.0 | 1.3 | 0.3 | 7.5 | 0.8 ±0.05 |
| 18 × 20 | 1.5 | 3.0 | 1.3 | 0.3 | 7.5 | 0.8 ±0.1 |
| 18 × 25 | 1.5 | 3.0 | 1.3 | 0.3 | 7.5 | 0.8 ±0.1 |
| 18 × 31.5 | 1.5 | 3.0 | 1.3 | 0.3 | 7.5 | 0.8 ±0.1 |
| 18 × 35 | 1.5 | 3.0 | 1.3 | 0.3 | 7.5 | 0.8 ±0.1 |
| 18 × 40 | 1.5 | 3.0 | 1.3 | 0.3 | 7.5 | 0.8 ±0.1 |

J leads

Last 3 digits of ordering code: 004

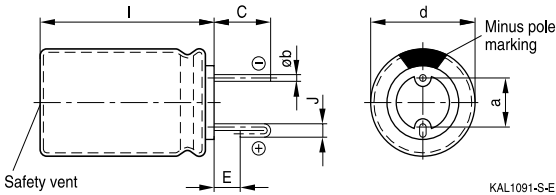
Suggestion for PCB hole diameter

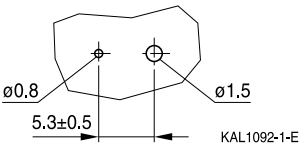
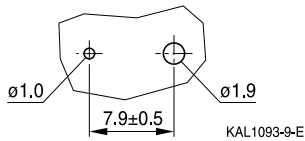
 Suggestion for PCB hole diameter,
wire $\varnothing 0.6$ mm

 Suggestion for PCB hole diameter,
wire $\varnothing 0.8$ mm

| Case size $d \times l$ (mm) | Dimensions (mm) | | | | |
|--------------------------------|-----------------|-------------|-------------|-------------|-----------------|
| | $C \pm 0.5$ | $E \pm 0.5$ | $J \pm 0.2$ | $a \pm 0.5$ | $\varnothing b$ |
| 10 × 12.5 | 3.2 | 0.7 | 1.2 | 5.0 | 0.6 ±0.05 |
| 10 × 16 | 3.2 | 0.7 | 1.2 | 5.0 | 0.6 ±0.05 |
| 10 × 20 | 3.2 | 0.7 | 1.2 | 5.0 | 0.6 ±0.05 |
| 12.5 × 20 | 3.2 | 0.7 | 1.2 | 5.0 | 0.6 ±0.05 |
| 12.5 × 25 | 3.2 | 0.7 | 1.2 | 5.0 | 0.6 ±0.05 |
| 16 × 20 | 3.5 | 0.7 | 1.6 | 7.5 | 0.8 ±0.05 |
| 16 × 25 | 3.5 | 0.7 | 1.6 | 7.5 | 0.8 ±0.05 |
| 16 × 31.5 | 3.5 | 0.7 | 1.6 | 7.5 | 0.8 ±0.05 |
| 16 × 35.5 | 3.5 | 0.7 | 1.6 | 7.5 | 0.8 ±0.05 |
| 18 × 20 | 3.5 | 0.7 | 1.6 | 7.5 | 0.8 ±0.1 |
| 18 × 25 | 3.5 | 0.7 | 1.6 | 7.5 | 0.8 ±0.1 |
| 18 × 31.5 | 3.5 | 0.7 | 1.6 | 7.5 | 0.8 ±0.1 |
| 18 × 35 | 3.5 | 0.7 | 1.6 | 7.5 | 0.8 ±0.1 |



B41890

Extended useful life – 105 °C

Bent 90° leads for horizontal mounting pinning

Last 3 digits of ordering code: 012

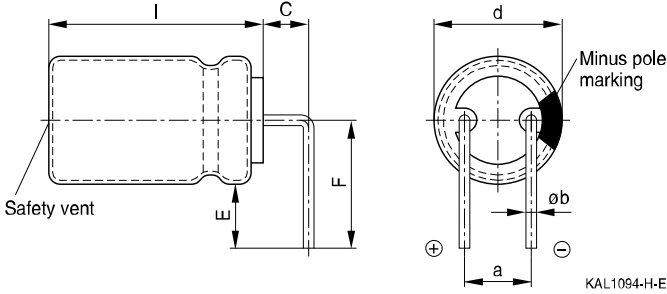

| Case size $d \times l$ (mm) | Dimensions (mm) | | | | |
|--------------------------------|-----------------|-------------|-------------|-------------|-----------------|
| | $C \pm 0.5$ | $E \pm 0.5$ | $F \pm 0.5$ | $a \pm 0.5$ | $\varnothing b$ |
| 16 × 20 | 4.0 | 4.0 | 12.0 | 7.5 | 0.8 ± 0.05 |
| 16 × 25 | 4.0 | 4.0 | 12.0 | 7.5 | 0.8 ± 0.05 |
| 16 × 31.5 | 4.0 | 4.0 | 12.0 | 7.5 | 0.8 ± 0.05 |
| 16 × 35.5 | 4.0 | 4.0 | 12.0 | 7.5 | 0.8 ± 0.05 |
| 18 × 20 | 4.0 | 4.0 | 13.0 | 7.5 | 0.8 ± 0.1 |
| 18 × 25 | 4.0 | 4.0 | 13.0 | 7.5 | 0.8 ± 0.1 |
| 18 × 31.5 | 4.0 | 4.0 | 13.0 | 7.5 | 0.8 ± 0.1 |
| 18 × 35 | 4.0 | 4.0 | 13.0 | 7.5 | 0.8 ± 0.1 |
| 18 × 40 | 4.0 | 4.0 | 13.0 | 7.5 | 0.8 ± 0.1 |

Bent leads for diameter 12.5 mm available upon request.



Packing units and box dimensions

Ammo pack

Valid for series B41002, B41022, B41044, B41827, B41828, B43044, B43082, B43086, B43088, B43827, B43828.

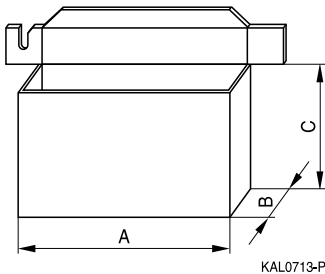

| Case size d × l mm | Dimensions (mm) | | | Packing units pcs. |
|--------------------------|------------------|------------------|------------------|--------------------------|
| | A _{max} | B _{max} | C _{max} | |
| 4 × 7 | 330 | 50 | 196 | 2000 |
| 5 × 7 | 330 | 50 | 226 | 2000 |
| 5 × 11 | 330 | 50 | 226 | 2000 |
| 6.3 × 7 | 330 | 50 | 286 | 2000 |
| 6.3 × 11 | 330 | 50 | 286 | 2000 |
| 8 × 7 | 330 | 50 | 246 | 1000 |
| 8 × 11.5 | 330 | 50 | 246 | 1000 |
| 8 × 15 | 330 | 50 | 246 | 500 |
| 10 × 12.5 | 330 | 50 | 196 | 500 |
| 10 × 16 | 330 | 54 | 196 | 500 |
| 10 × 20 | 330 | 58 | 196 | 500 |
| 12.5 × 20 | 341 | 60 | 272 | 500 |
| 12.5 × 25 | 341 | 65 | 272 | 500 |
| 16 × 25 | 320 | 65 | 270 | 300 |
| 16 × 31.5 | 315 | 65 | 275 | 300 |
| 18 × 20 | 315 | 65 | 275 | 250 |
| 18 × 25 | 315 | 65 | 275 | 250 |
| 18 × 31.5 | 315 | 65 | 275 | 250 |



B41890

Extended useful life – 105 °C

Ammo pack

Valid for series B41858, B41859, B41863, B41866, B41868, B41888, B41890, B41896, B42824, B42851, B43866, B43867, B43890, B43896.

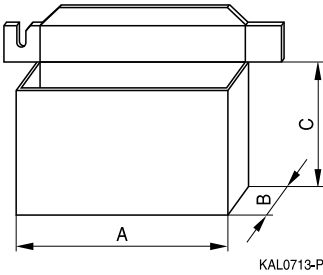

| Case size d × l mm | Dimensions (mm) | | | Packing units pcs. |
|--------------------------|------------------|------------------|------------------|--------------------------|
| | A _{max} | B _{max} | C _{max} | |
| 8 × 11.5 | 345 | 55 | 240 | 1000 |
| 10 × 12.5 | 345 | 55 | 280 | 750 |
| 10 × 16 | 345 | 60 | 200 | 500 |
| 10 × 20 | 345 | 60 | 200 | 500 |
| 12.5 × 20 | 345 | 65 | 280 | 500 |
| 12.5 × 25 | 345 | 65 | 280 | 500 |
| 16 × 20 | 315 | 65 | 275 | 300 |
| 16 × 25 | 315 | 65 | 275 | 300 |
| 16 × 31.5 | 315 | 65 | 275 | 300 |
| 18 × 20 | 315 | 65 | 275 | 250 |
| 18 × 25 | 315 | 65 | 275 | 250 |
| 18 × 31.5 | 315 | 65 | 275 | 250 |

Overview of packing units and code numbers for case sizes 4 x 7 ... 16 x 40

Valid for series B41002, B41022, B41044, B41827, B41828, B43044, B43082, B43086, B43088, B43827, B43828.

| Case size d x l mm | Standard, bulk pcs. | Taped, Ammo pack pcs. | Kinked leads, bulk pcs. | Cut leads, bulk pcs. | | |
|---|---------------------------|-----------------------------|-------------------------------|----------------------------|------------|------------|
| 4 x 7 | 10000 | 2000 | 15000 | 15000 | | |
| 5 x 7 | 7500 | 2000 | 10000 | 10000 | | |
| 5 x 11 | 5000 | 2000 | 10000 | 10000 | | |
| 6.3 x 7 | 5000 | 2000 | 10000 | 10000 | | |
| 6.3 x 11 | 5000 | 2000 | 5000 | 5000 | | |
| 8 x 7 | 5000 | 1000 | 5000 | 5000 | | |
| 8 x 11.5 | 2500 | 1000 | 4000 | 4000 | | |
| 8 x 15 | 2000 | 1000 | 2500 | 2500 | | |
| 8 x 20 | 1500 | – | 2000 | 2000 | | |
| 10 x 12.5 | 2000 | 500 | 2500 | 2500 | | |
| 10 x 16 | 1500 | 500 | 2000 | 2000 | | |
| 10 x 20 | 1000 | 500 | 1500 | 1500 | | |
| 10 x 25 | 1000 | 500 | 1250 | 1250 | | |
| 12.5 x 16 | 750 | 500 | 1000 | 1000 | | |
| 12.5 x 20 | 750 | 500 | 500 | 500 | | |
| 12.5 x 25 | 750 | 500 | 500 | 500 | | |
| 12.5 x 31.5 | 500 | – | 750 | 750 | | |
| 12.5 x 35.5 | 500 | – | 750 | 750 | | |
| 12.5 x 40 | 500 | – | 750 | 750 | | |
| 16 x 20 | 375 | 300 | 500 | 500 | | |
| 16 x 25 | 375 | 300 | 500 | 500 | | |
| 16 x 31.5 | 250 | 300 | 375 | 375 | | |
| 16 x 35.5 | 250 | – | 375 | 375 | | |
| 16 x 40 | 250 | – | 375 | 375 | | |
| The last three digits of the complete ordering code state the lead configuration | 000 | Code | F (mm) | d (mm) | 001 | 002 |
| | | 006 | 3.5 | 8 | | |
| | | 007 | 2.5 | 4 ... 6.3 | | |
| | | 008 | 5.0 | 4 ... 12.5 | | |
| | | 009 | 7.5 | 16 ... 18 | | |
| | | 016 | 2.0 | 4 ... 5 | | |

B41890
Extended useful life – 105 °C
Overview of packing units and code numbers for case sizes 18 x 20 ... 18 x 40

Valid for series B41002, B41022, B41044, B41827, B41828, B43044, B43082, B43086, B43088, B43827, B43828.

| Case size d x l mm | Standard, bulk pcs. | Taped, Ammo pack pcs. | | | Kinked leads, bulk pcs. | Cut leads, bulk pcs. |
|---|---------------------------|-----------------------------|--------|-----------|-------------------------------|----------------------------|
| 18 x 20 | 250 | 250 | | | 100 | 100 |
| 18 x 25 | 250 | 250 | | | 100 | 100 |
| 18 x 31.5 | 250 | 250 | | | 100 | 100 |
| 18 x 35.5 | 250 | – | | | 100 | 100 |
| 18 x 40 | 250 | – | | | 100 | 100 |
| The last three digits of the complete ordering code state the lead configuration | 000 | Code | F (mm) | d (mm) | 001 | 002 |
| | | 009 | 7.5 | 16 ... 18 | | |

Overview of packing units and code numbers for case sizes 8 × 11.5 ... 16 × 35.5

Valid for series B41858, B41859, B41863, B41866, B41868, B41888, B41890, B41896, B42824, B42851, B43866, B43867, B43890, B43896.

| | | | | | PAPR | | | | |
|---|------------------------|---------------------|--------|--------------------------|-----------------------|------------------------------|---------------------|-------------------------------|------------|
| Case size d × l | Stan- dard, bulk | Taped, Ammo pack | | Kinked leads, bulk | Cut leads, bulk | Crimped leads, blister | J leads, blister | Bent 90° leads, blister | |
| mm | pcs. | pcs. | | pcs. | pcs. | pcs. | pcs. | pcs. | |
| 8 × 11.5 | 1000 | 1000 | | – | – | – | – | | |
| 10 × 12.5 | 1000 | 750 | | – | 1000 | – | 675 | | |
| 10 × 16 | 1000 | 500 | | – | 1000 | – | 675 | | |
| 10 × 20 | 500 | 500 | | 500 | 500 | – | 500 | | |
| 12.5 × 20 | 350 | 500 | | 350 | 350 | – | 300 | 1) | |
| 12.5 × 25 | 250 | 500 | | 500 | 500 | – | 225 | 1) | |
| 12.5 × 30 | 200 | – | | – | – | – | – | | |
| 12.5 × 35 | 175 | – | | – | – | – | – | | |
| 12.5 × 40 | 175 | – | | – | – | – | – | | |
| 16 × 20 | 250 | 300 | | 200 | 200 | 200 | 200 | 120 | |
| 16 × 25 | 250 | 300 | | 200 | 200 | 200 | 200 | 120 | |
| 16 × 31.5 | 200 | 300 | | 250 | 250 | 344 | 344 | 120 | |
| 16 × 35.5 | 100 | – | | 100 | 100 | 150 | 150 | 150 | |
| The last three digits of the complete ordering code state the lead configuration | 000 | Code | F (mm) | d (mm) | 001 | 002 | 003 | 004 | 012 |
| | | 006 | 3.5 | 8 | | | | | |
| | | 008 | 5 | 5...12.5 | | | | | |
| | | 009 | 7.5 | 16...18 | | | | | |

1) Available upon request

B41890
Extended useful life – 105 °C
Overview of packing units and code numbers for case sizes 18 × 20 ... 18 × 40

Valid for series B41858, B41859, B41863, B41866, B41868, B41888, B41890, B41896, B42824, B42851, B43866, B43867, B43890, B43896.

| | | | | | PAPR | | | | |
|---|---------------------------|-----------------------------|--------|---------|----------------------------------|-------------------------------|--------------------------------------|-----------------------------|---------------------------------------|
| Case size d × l mm | Standard, bulk pcs. | Taped, Ammo pack pcs. | | | Kinked leads, bulk pcs. | Cut leads, bulk pcs. | Crimped leads, blister pcs. | J leads, blister pcs. | Bent 90° leads, blister pcs. |
| 18 × 20 | 175 | 250 | | | 175 | 175 | 200 | 200 | 120 |
| 18 × 25 | 150 | 250 | | | 150 | 150 | 200 | 200 | 120 |
| 18 × 31.5 | 100 | 250 | | | 100 | 100 | 150 | 150 | 120 |
| 18 × 35 | 100 | – | | | 100 | 100 | 150 | 150 | 150 |
| 18 × 40 | 125 | – | | | 100 | 100 | 120 | – | 72 |
| The last three digits of the complete ordering code state the lead configuration | 000 | Code | F (mm) | d (mm) | 001 | 002 | 003 | 004 | 012 |
| | | 009 | 7.5 | 16...18 | | | | | |



Cautions and warnings

Personal safety

The electrolytes used by EPCOS have not only been optimized with a view to the intended application, but also with regard to health and environmental compatibility. They do not contain any solvents that are detrimental to health, e.g. dimethyl formamide (DMF) or dimethyl acetamide (DMAC).

Furthermore, part of the high-voltage electrolytes used by EPCOS are self-extinguishing. They contain flame-retarding substances which will quickly extinguish any flame that may have been ignited.

As far as possible, EPCOS does not use any dangerous chemicals or compounds to produce operating electrolytes. However, in exceptional cases, such materials must be used in order to achieve specific physical and electrical properties because no safe substitute materials are currently known. However, the amount of dangerous materials used in our products has been limited to an absolute minimum. Nevertheless, the following rules should be observed when handling aluminum electrolytic capacitors:

- Any escaping electrolyte should not come into contact with eyes or skin.
- If electrolyte does come into contact with the skin, wash the affected parts immediately with running water. If the eyes are affected, rinse them for 10 minutes with plenty of water. If symptoms persist, seek medical treatment.
- Avoid breathing in electrolyte vapor or mists. Workplaces and other affected areas should be well ventilated. Clothing that has been contaminated by electrolyte must be changed and rinsed in water.



Product safety

The table below summarizes the safety instructions that must be observed without fail. A detailed description can be found in the relevant sections of chapter "General technical information".

| Topic | Safety information | Reference chapter "General technical information" |
|--|---|--|
| Polarity | Make sure that polar capacitors are connected with the right polarity. | 1 "Basic construction of aluminum electrolytic capacitors" |
| Reverse voltage | Voltages polarity classes should be prevented by connecting a diode. | 3.1.6 "Reverse voltage" |
| Upper category temperature | Do not exceed the upper category temperature. | 7.2 "Maximum permissible operating temperature" |
| Maintenance | Make periodic inspections of the capacitors. Before the inspection, make sure that the power supply is turned off and carefully discharge the electricity of the capacitors. Do not apply any mechanical stress to the capacitor terminals. | 10 "Maintenance" |
| Mounting position of screw-terminal capacitors | Do not mount the capacitor with the terminals (safety vent) upside down. | 11.1. "Mounting positions of capacitors with screw terminals" |
| Mounting of single-ended capacitors | The internal structure of single-ended capacitors might be damaged if excessive force is applied to the lead wires. Avoid any compressive, tensile or flexural stress. Do not move the capacitor after soldering to PC board. Do not pick up the PC board by the soldered capacitor. Do not insert the capacitor on the PC board with a hole space different to the lead space specified. | 11.4 "Mounting considerations for single-ended capacitors" |
| Robustness of terminals | The following maximum tightening torques must not be exceeded when connecting screw terminals: M5: 2 Nm M6: 2.5 Nm | 11.3 "Mounting torques" |
| Soldering | Do not exceed the specified time or temperature limits during soldering. | 11.5 "Soldering" |



| Topic | Safety information | Reference chapter "General technical information" |
|--|---|---|
| Soldering, cleaning agents | Do not allow halogenated hydrocarbons to come into contact with aluminum electrolytic capacitors. | 11.6 "Cleaning agents" |
| Passive flammability | Avoid external energy, such as fire or electricity. | 8.1 "Passive flammability" |
| Active flammability | Avoid overload of the capacitors. | 8.2 "Active flammability" |
| | | Reference chapter "Capacitors with screw terminals" |
| Breakdown strength of insulating sleeves | Do not damage the insulating sleeve, especially when ring clips are used for mounting. | "Screw terminals – accessories" |

B41890
Extended useful life – 105 °C
Symbols and terms

| Symbol | English | German |
|----------------|---|---|
| C | Capacitance | Kapazität |
| C_R | Rated capacitance | Nennkapazität |
| C_S | Series capacitance | Serienkapazität |
| $C_{S,T}$ | Series capacitance at temperature T | Serienkapazität bei Temperatur T |
| C_f | Capacitance at frequency f | Kapazität bei Frequenz f |
| d | Case diameter, nominal dimension | Gehäusedurchmesser, Nennmaß |
| d_{max} | Maximum case diameter | Maximaler Gehäusedurchmesser |
| ESL | Self-inductance | Eigeninduktivität |
| ESR | Equivalent series resistance | Ersatzserienwiderstand |
| ESR_f | Equivalent series resistance at frequency f | Ersatzserienwiderstand bei Frequenz f |
| ESR_T | Equivalent series resistance at temperature T | Ersatzserienwiderstand bei Temperatur T |
| f | Frequency | Frequenz |
| I | Current | Strom |
| I_{AC} | Alternating current (ripple current) | Wechselstrom |
| $I_{AC,rms}$ | Root-mean-square value of alternating current | Wechselstrom, Effektivwert |
| $I_{AC,f}$ | Ripple current at frequency f | Wechselstrom bei Frequenz f |
| $I_{AC,max}$ | Maximum permissible ripple current | Maximal zulässiger Wechselstrom |
| $I_{AC,R}$ | Rated ripple current | Nennwechselstrom |
| $I_{AC,R} (B)$ | Rated ripple current for base cooling | Nennwechselstromstrom für Bodenkühlung |
| I_{leak} | Leakage current | Reststrom |
| $I_{leak,op}$ | Operating leakage current | Betriebsreststrom |
| l | Case length, nominal dimension | Gehäuselänge, Nennmaß |
| l_{max} | Maximum case length (without terminals and mounting stud) | Maximale Gehäuselänge (ohne Anschlüsse und Gewindebolzen) |
| R | Resistance | Widerstand |
| R_{ins} | Insulation resistance | Isolationswiderstand |
| R_{symm} | Balancing resistance | Symmetrierwiderstand |
| T | Temperature | Temperatur |
| ΔT | Temperature difference | Temperaturdifferenz |
| T_A | Ambient temperature | Umgebungstemperatur |
| T_C | Case temperature | Gehäusetemperatur |
| T_B | Capacitor base temperature | Temperatur des Becherbodens |
| t | Time | Zeit |
| Δt | Period | Zeitraum |
| t_b | Service life (operating hours) | Brauchbarkeitsdauer (Betriebszeit) |



| Symbol | English | German |
|-----------------|-----------------------------|-----------------------------------|
| V | Voltage | Spannung |
| V _F | Forming voltage | Formierspannung |
| V _{op} | Operating voltage | Betriebsspannung |
| V _R | Rated voltage, DC voltage | Nennspannung, Gleichspannung |
| V _S | Surge voltage | Spitzenspannung |
| X _C | Capacitive reactance | Kapazitiver Blindwiderstand |
| X _L | Inductive reactance | Induktiver Blindwiderstand |
| Z | Impedance | Scheinwiderstand |
| Z _T | Impedance at temperature T | Scheinwiderstand bei Temperatur T |
| tan δ | Dissipation factor | Verlustfaktor |
| λ | Failure rate | Ausfallrate |
| ε ₀ | Absolute permittivity | Elektrische Feldkonstante |
| ε _r | Relative permittivity | Dielektrizitätszahl |
| ω | Angular velocity; 2 · π · f | Kreisfrequenz; 2 · π · f |

Note

All dimensions are given in mm.

Important notes

The following applies to all products named in this publication:

1. Some parts of this publication contain **statements about the suitability of our products for certain areas of application**. These statements are based on our knowledge of typical requirements that are often placed on our products in the areas of application concerned. We nevertheless expressly point out **that such statements cannot be regarded as binding statements about the suitability of our products for a particular customer application**. As a rule, EPCOS is either unfamiliar with individual customer applications or less familiar with them than the customers themselves. For these reasons, it is always ultimately incumbent on the customer to check and decide whether an EPCOS product with the properties described in the product specification is suitable for use in a particular customer application.
2. We also point out that **in individual cases, a malfunction of electronic components or failure before the end of their usual service life cannot be completely ruled out in the current state of the art, even if they are operated as specified**. In customer applications requiring a very high level of operational safety and especially in customer applications in which the malfunction or failure of an electronic component could endanger human life or health (e.g. in accident prevention or lifesaving systems), it must therefore be ensured by means of suitable design of the customer application or other action taken by the customer (e.g. installation of protective circuitry or redundancy) that no injury or damage is sustained by third parties in the event of malfunction or failure of an electronic component.
3. **The warnings, cautions and product-specific notes must be observed.**
4. In order to satisfy certain technical requirements, **some of the products described in this publication may contain substances subject to restrictions in certain jurisdictions (e.g. because they are classed as hazardous)**. Useful information on this will be found in our Material Data Sheets on the Internet (www.epcos.com/material). Should you have any more detailed questions, please contact our sales offices.
5. We constantly strive to improve our products. Consequently, **the products described in this publication may change from time to time**. The same is true of the corresponding product specifications. Please check therefore to what extent product descriptions and specifications contained in this publication are still applicable before or when you place an order. We also **reserve the right to discontinue production and delivery of products**. Consequently, we cannot guarantee that all products named in this publication will always be available. The aforementioned does not apply in the case of individual agreements deviating from the foregoing for customer-specific products.
6. Unless otherwise agreed in individual contracts, **all orders are subject to the current version of the "General Terms of Delivery for Products and Services in the Electrical Industry" published by the German Electrical and Electronics Industry Association (ZVEI)**.
7. The trade names EPCOS, BAOKE, Alu-X, CeraDiode, CSMP, CSSP, CTVS, DeltaCap, DigiSiMic, DSSP, FormFit, MiniBlue, MiniCell, MKK, MKD, MLSC, MotorCap, PCC, PhaseCap, PhaseCube, PhaseMod, PhiCap, SIFERRIT, SIFI, SIKOREL, SilverCap, SIMDAD, SiMic, SIMID, SineFormer, SIOV, SIP5D, SIP5K, ThermoFuse, WindCap are **trade-marks registered or pending** in Europe and in other countries. Further information will be found on the Internet at www.epcos.com/trademarks.