

Very low impedance

Operating at temperatures up to 105° C

Construction

- Radial leads
- Charge-discharge proof, polar
- Aluminum case with insulating sleeve
- Minus pole marking on case surface
- Case with safety vent from diameter 8mm
- Stand off rubber seal

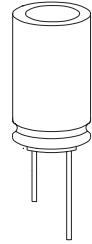

Features

- Very low impedance at high frequency
- Very low equivalent series resistance *ESR*
- High ripple current capability
- Wide temperature range

Applications

- For use in output circuits of switch-mode power supplies of compact design
- For professional industrial electronics, telecommunications and data processing equipment

Special terminals configurations and packaging

Refer to page 163 for information and examples on how to order them.

Specifications and characteristics in brief

Rated voltage V_R	10 ... 50 Vdc
Surge voltage V_S	$1,15 \cdot V_R$
Rated capacitance C_R	100 ... 4 700 μ F
Capacitance tolerance	± 20 % (M)
Useful life	
105 °C, V_R ; $I_{aC_{max}}$	> 3 000 h for $d = 8$ mm
105 °C, V_R ; $I_{aC_{max}}$	> 5 000 h for $d \geq 10$ mm
Fraction failure	≤ 1 % (during the useful life)
Failure rate (1 fit = $1 \cdot 10^{-9}$ /h)	≤ 100 fit

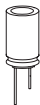

B41858

Voltage endurance test	2 000 h, 105 °C for d = 8 mm at V_R 5 000 h, 105 °C for ≥ 10 mm at V_R Evaluation criteria: $\Delta C/C \leq \pm 30$ % of initial measured value $\tan \delta \leq 2$ times initial specified value $I_L \leq$ initial specified value
Leakage current I_{lka} (5 min, 20 °C)	$I_{lka} \leq 0,01 \mu A \cdot \left(\frac{C_R}{\mu F} \cdot \frac{V_R}{V} \right)$
IEC climatic category	in accordance with IEC 68-1 55/105/56 (-55 0C/ +105 0C, 56 days of damp heat, stead state test
Sectional specifications	IEC 384-4 DIN 45 910 part 12
Vibration resistance	in accordance with IEC 68-2-6, test Fc: displacement amplitude 0,75 mm, frequency range 10 ... 2000 Hz, acceleration max. 10 g, duration 3 x 2 h

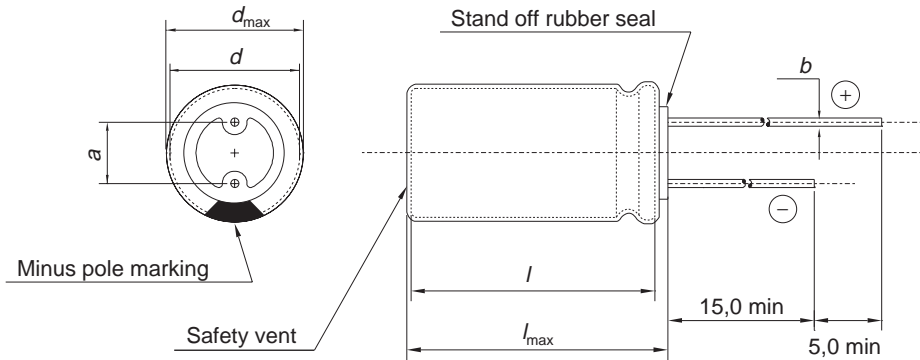
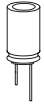

Dimensions (mm)				Approx. weight (g)
$d \times l$	$d_{max} \times l_{max}$	$a \pm 0,5$	$b \pm 0,05$	
8 x 11	8,5 x 12	3,5	0,6	1,0
10 x 16	10,5 x 17	5,0	0,6	1,9
10 x 20	10,5 x 22	5,0	0,6	2,6
12,5 x 25	13 x 27	5,0	0,6	4,5
16 x 20	16,5 x 22	7,5	0,8	5,5
16 x 25	16,5 x 27	7,5	0,8	7,5
16 x 31,5	16,5 x 33,5	7,5	0,8	7,8
18 x 31,5	18,5 x 32,5	7,5	0,8	11,0
18 x 35	18,5 x 36	7,5	0,8	13,0
18 x 40	18,5 x 41	7,5	0,8	16,0

For $d = 18$ mm tolerance $b = \pm 0,1$

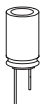

B41858

Packing units

Case dimensions $d \times l$ (mm)	Bulk PU (pcs.)	Cut / Kinked PU (pcs.)	AMMO packing PU (pcs.)
8 x 11	1000	500 / -	1000
10 x 16	1000	1000	500
10 x 20	500	500	500
12,5 x 25	250	500	500
16 x 20	250	200	
16 x 25	250	200	
16 x 31,5	200	250	
18 x 31,5	100	100	
18 x 35	100	100	
18 x 40	100	100	

Overview of available types

V_R (Vdc)	10	16	25	35	50
C_R (μ F)	Case dimensions $d \times l$ (mm)				
100			8 x 11	8 x 11	10 x 16
220		8 x 11	10 x 16	10 x 16	10 x 20
330	8 x 11	10 x 16	10 x 16	10 x 20	12,5 x 25
470	10 x 16	10 x 16	10 x 20	10 x 20	16 x 20
1 000	10 x 20	10 x 20	12,5 x 25	16 x 25	18 x 31,5
2 200	12,5 x 25	16 x 20	16 x 31,5	18 x 35	
3 300	16 x 20	16 x 31,5	18 x 35	18 x 40	
4 700	16 x 31,5	18 x 35	18 x 40		

Other voltage and capacitance ratings are also available upon request.

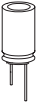

Technical data and ordering codes

V_R	C_R	Case Dimensions	I_{Lmax}	$\tan \delta_{max}$	ESR_{max}	I_{aC_R}	Z_{max}	Ordering code
V_{dc}	120 Hz 20 °C μF	$d \times l$ mm	5 min 20 °C μA	120 Hz 20 °C	120 Hz 20 °C Ω	100 kHz 105 °C mA	100 kHz 20 °C Ω	Short Code
10	330	8 x 11	33	0,19	0,95	440	0,170	-A3337-M
	470	10 x 16	47	0,19	0,67	640	0,120	-A3477-M
	1 000	10 x 20	100	0,19	0,31	1120	0,062	-A3108-M
	2 200	12,5 x 25	220	0,21	0,16	1620	0,034	-A3228-M
	3 300	16 x 20	330	0,23	0,12	1700	0,030	-A3338-M
	4 700	16 x 31,5	470	0,25	0,09	2210	0,024	-A3478-M
16	220	8 x 11	35	0,16	1,21	530	0,120	-A4227-M
	330	10 x 16	53	0,16	0,80	640	0,100	-A4337-M
	470	10 x 16	75	0,16	0,56	840	0,084	-A4477-M
	1 000	10 x 20	160	0,16	0,27	1340	0,050	-A4108-M
	2 200	16 x 20	352	0,18	0,14	1800	0,030	-A4228-M
	3 300	16 x 31,5	528	0,20	0,10	2310	0,024	-A4338-M
25	4 700	18 x 35	752	0,22	0,08	2790	0,018	-A4478-M
	100	8 x 11	25	0,14	2,32	340	0,180	-A5107-M
	220	10 x 16	55	0,14	1,06	620	0,120	-A5227-M
	330	10 x 16	83	0,14	0,70	830	0,084	-A5337-M
	470	10 x 20	118	0,14	0,49	1080	0,062	-A5477-M
	1 000	12,5 x 25	250	0,14	0,23	1690	0,034	-A5108-M
35	2 200	16 x 31,5	550	0,16	0,12	2310	0,024	-A5228-M
	3 300	18 x 35	825	0,18	0,09	2740	0,018	-A5338-M
	4 700	18 x 40	1175	0,20	0,07	3090	0,015	-A5478-M
	100	8 x 11	35	0,12	1,99	500	0,120	-A7107-M
	220	10 x 16	77	0,12	0,90	820	0,084	-A7227-M
	330	10 x 20	116	0,12	0,60	1090	0,062	-A7337-M
50	470	10 x 20	165	0,12	0,42	1200	0,052	-A7477-M
	1 000	16 x 25	350	0,12	0,20	1960	0,030	-A7108-M
	2 200	18 x 35	770	0,14	0,11	2850	0,018	-A7228-M
	3 300	18 x 40	1155	0,16	0,08	3150	0,015	-A7338-M
	100	10 x 16	50	0,10	1,66	640	0,130	-A6107-M
	220	10 x 20	110	0,10	0,75	1050	0,080	-A6227-M
50	330	12,5 x 25	165	0,10	0,50	1400	0,062	-A6337-M
	470	16 x 20	235	0,10	0,35	1240	0,048	-A6477-M
	1 000	18 x 31,5	500	0,10	0,17	2310	0,030	-A6108-M

How to determine the ordering code

To obtain the required ordering code, prefix the type number to the short code.
E.g.: B41858-A6107-M

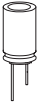

B41858

Useful life

versus temperature T_A under ripple operating conditions ¹⁾
 $V_R = 10 \dots 50$ Vdc

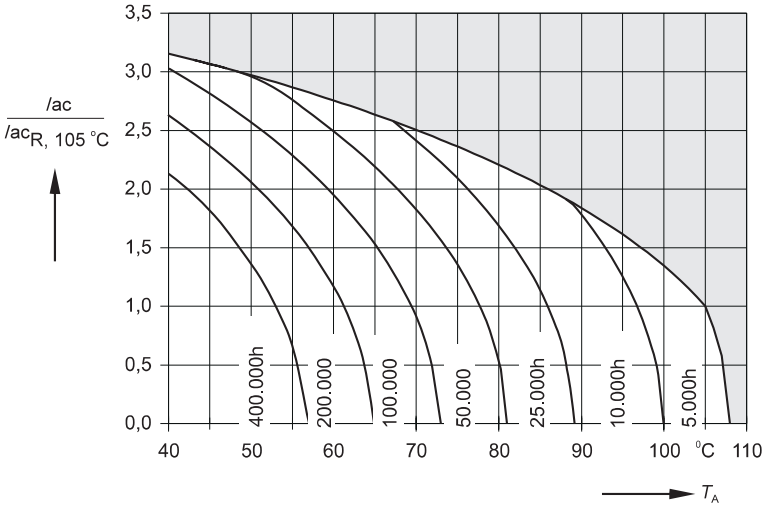

Permissible ripple current I_{ac} versus frequency f

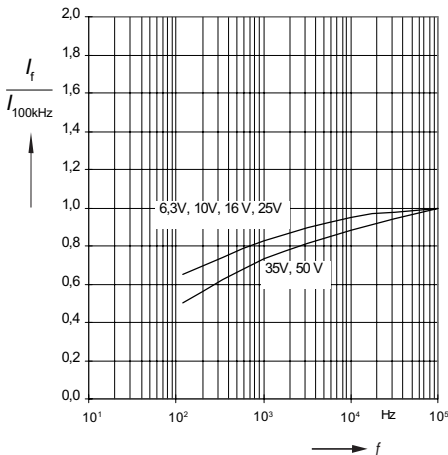

Impedance Z versus frequency f Typical values at 20 °C

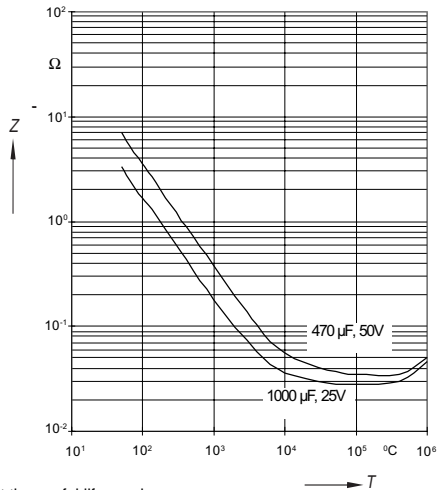

¹⁾ Refer to page 32 for an explanation on how to interpret the useful life graph.