



Aluminum electrolytic capacitors

Single-ended capacitors

Series/Type: B41827, B43827

Date: December 2010

General-purpose grade capacitors

Applications

- General-purpose applications
- Semi-professional to professional application range
- For filtering, coupling and pulse circuits

Features

- Miniaturized dimensions
- RoHS-compatible
- Useful life of 2000 h at 85 °C

Construction

- Radial leads
- Charge-discharge proof, polar
- Aluminum case with insulating sleeve
- Minus pole marking on the insulating sleeve
- Case with safety vent from diameter 8 mm

Delivery mode

- Bulk
- Taped, Ammo pack
- Cut (see chapter "Single-ended – Taping, packing and lead configurations, Cut leads (Chapter A)")
- Kinked (see chapter "Single-ended – Taping, packing and lead configurations, Kinked leads (Chapter A)")

Refer to chapter "Single-ended capacitors – Taping, packing and lead configurations" for further details.



Specifications and characteristics in brief

Series	B41827		B43827										
Rated voltage V_R	6.3 ... 100 V DC											160 ... 450 V DC	
Surge voltage V_S	$V_R \leq 250$ V DC: $1.15 \cdot V_R$ (at room temperature) $V_R > 250$ V DC: $1.1 \cdot V_R$ (at room temperature)												
Rated capacitance C_R	0.47 ... 22000 μ F						0.47 ... 330 μ F						
Capacitance tolerance	$\pm 20\% \triangleq M$						$\pm 20\% \triangleq M$						
Dissipation factor (max.) (20 °C, 120 Hz)	For capacitance higher than 1000 μ F add 0.02 for every increase of 1000 μ F.												
	V_R (V DC)	6.3	10	16	25	35	50	63	100	160 ... 250	350 ... 400	450	
	$\tan \delta$	0.22	0.20	0.16	0.14	0.12	0.10	0.09	0.08	0.18	0.20	0.23	
Leakage current I_{leak} (20 °C, after 5 minutes)	$I_{leak} \leq 0.01 \mu A \cdot \left(\frac{C_R}{\mu F} \cdot \frac{V_R}{V} \right)$ or 3 μA , whichever is greater						$I_{leak} \leq 0.03 \mu A \cdot \left(\frac{C_R}{\mu F} \cdot \frac{V_R}{V} \right) + 10 \mu A$						
Useful life 85 °C; V_R ; $I_{AC,R}$	> 2000 h												
Requirements	$\Delta C/C \leq \pm 20\%$ of initial value $\tan \delta \leq 2$ times initial specified value $I_{leak} \leq$ initial specified limit												
Shelf life	After storage for 1000 h at 85 °C, the capacitors shall meet the requirement of load life test after reforming process. After test: V_R to be applied for 30 minutes, 24 to 48 hours before measurement.												
Vibration resistance test	To IEC 60068-2-6, test Fc: Frequency range 10 ... 55 Hz, displacement amplitude 0.75 mm, acceleration max. 10 g, duration 3 \times 2 h. If can size D <16 mm, capacitor is mounted by the leads If can size D \geq 16 mm, capacitor rigidly clamped by the aluminum case												
IEC climatic category	To IEC 60068-1: $V_R \leq 100$ V DC: 40/085/56 (–40 °C/+85 °C/56 days damp heat test) $V_R > 100$ V DC: 25/085/56 (–25 °C/+85 °C/56 days damp heat test)												



B41827, B43827

Standard series – 85 °C

Dimensional drawing

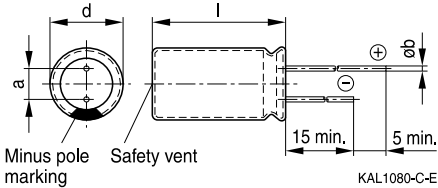

Safety vent for diameter ≥ 8 mm.

Case Dimensions

$d \times l$ mm	$d_{\max} \times l_{\max}$ mm	a mm	b mm
5 × 11	5.5 × 12.5	2.0 ±0.5	0.50 ±0.1
6.3 × 11	6.8 × 12.5	2.5 ±0.5	0.50 ±0.1
8 × 11.5	8.5 × 13.0	3.5 ±0.5	0.60 ±0.1
10 × 12.5	11.0 × 14.0	5.0 ±0.5	0.60 ±0.1
10 × 16	11.0 × 17.5	5.0 ±0.5	0.60 ±0.1
10 × 20	11.0 × 22.0	5.0 ±0.5	0.60 ±0.1
12.5 × 20	13.5 × 22.0	5.0 ±0.5	0.60 ±0.1
12.5 × 25	13.5 × 27.0	5.0 ±0.5	0.60 ±0.1
16 × 25	17.0 × 27.0	7.5 ±0.5	0.80 ±0.1
16 × 31.5	17.0 × 33.5	7.5 ±0.5	0.80 ±0.1
16 × 35.5	17.0 × 37.5	7.5 ±0.5	0.80 ±0.1
18 × 35.5	19.0 × 37.5	7.5 ±0.5	0.80 ±0.1
18 × 40	19.0 × 42.0	7.5 ±0.5	0.80 ±0.1

Overview of available types – B41827

V_R (V DC)	6.3	10	16	25
	Case dimensions $d \times l$ (mm)			
C_R (μF)				
47				5 × 11
100		5 × 11	5 × 11	6.3 × 11
220	5 × 11	6.3 × 11	6.3 × 11	8 × 11.5
330	6.3 × 11	6.3 × 11	8 × 11.5	10 × 12.5
470	6.3 × 11	8 × 11.5	8 × 11.5	10 × 12.5
1000	10 × 12.5	10 × 12.5	10 × 16	10 × 20
2200	10 × 20	10 × 20	12.5 × 20	12.5 × 25
3300	12.5 × 20	12.5 × 20	12.5 × 25	16 × 25
4700	12.5 × 25	12.5 × 25	16 × 25	16 × 31.5
6800	16 × 25			
10000	16 × 25	16 × 35.5	18 × 35.5	
15000	16 × 35.5	18 × 35.5		
22000	18 × 40			

B41827
Standard series – 85 °C

V_R (V DC)	35	50	63	100
	Case dimensions $d \times l$ (mm)			
C_R (μF)				
0.47				5 × 11
1.0				5 × 11
2.2				5 × 11
3.3				5 × 11
4.7				5 × 11
10		5 × 11	5 × 11	6.3 × 11
22		5 × 11	6.3 × 11	8 × 11.5
33	5 × 11	5 × 11	6.3 × 11	10 × 12.5
47	5 × 11	6.3 × 11	6.3 × 11	10 × 12.5
100	6.3 × 11	8 × 11.5	10 × 12.5	10 × 20
220	10 × 12.5	10 × 12.5	10 × 20	12.5 × 25
330	10 × 12.5	10 × 16	12.5 × 20	16 × 25
470	10 × 16	10 × 20	12.5 × 25	16 × 31.5
1000	12.5 × 25	16 × 20	16 × 31.5	18 × 40
2200	16 × 25	16 × 31.5		
3300	16 × 31.5			
4700	18 × 35.5			

Overview of available types – B43827

V_R (V DC)	160	200	250	350	400	450
	Case dimensions $d \times l$ (mm)					
C_R (μF)						
0.47	5 × 11		5 × 11		6.3 × 11	8 × 11.5
1.0	5 × 11		5 × 11	6.3 × 11	6.3 × 11	8 × 11.5
2.2	5 × 11		6.3 × 11	8 × 11.5	8 × 11.5	10 × 12.5
3.3	6.3 × 11	6.3 × 11	6.3 × 11	10 × 12.5	10 × 12.5	10 × 16
4.7	6.3 × 11	8 × 11.5	8 × 11.5	10 × 12.5	10 × 16	10 × 20
10	8 × 11.5	10 × 12.5	10 × 12.5	10 × 20	12.5 × 20	12.5 × 20
22	10 × 16	10 × 20	10 × 20	12.5 × 25	16 × 25	16 × 25
33	10 × 20	12.5 × 20	12.5 × 25	16 × 25	16 × 25	16 × 31.5
47	12.5 × 25	12.5 × 20	12.5 × 25	16 × 35.5	16 × 35.5	18 × 40
100	16 × 25	16 × 25	16 × 31.5	18 × 40		
220	16 × 35.5	18 × 35.5				
330	18 × 35.5					

B41827
Standard series – 85 °C
Technical data and ordering codes – B41827

C_R 120 Hz, 20 °C μF	Case dimensions $d \times l$ mm	$I_{AC,R}$ 120 Hz, 85 °C mA	Ordering code (composition see below)
$V_R = 6.3 \text{ V DC}$			
220	5 × 11	200	B41827A2227M***
330	6.3 × 11	270	B41827A2337M***
470	6.3 × 11	321	B41827A2477M***
1000	10 × 12.5	542	B41827A2108M***
2200	10 × 20	1005	B41827A2228M***
3300	12.5 × 20	1195	B41827A2338M***
4700	12.5 × 25	1560	B41827A2478M***
6800	16 × 25	1925	B41827A2688M***
10000	16 × 25	2360	B41827A2109M***
15000	16 × 35.5	2855	B41827A2159M***
22000	18 × 40	3345	B41827A2229M***
$V_R = 10 \text{ V DC}$			
100	5 × 11	130	B41827A3107M***
220	6.3 × 11	280	B41827A3227M***
330	6.3 × 11	290	B41827A3337M***
470	8 × 11.5	385	B41827A3477M***
1000	10 × 12.5	650	B41827A3108M***
2200	10 × 20	1082	B41827A3228M***
3300	12.5 × 20	1436	B41827A3338M***
4700	12.5 × 25	1783	B41827A3478M***
10000	16 × 35.5	2700	B41827A3109M***
15000	18 × 35.5	3100	B41827A3159M***
$V_R = 16 \text{ V DC}$			
100	5 × 11	160	B41827A4107M***
220	6.3 × 11	261	B41827A4227M***
330	8 × 11.5	373	B41827A4337M***
470	8 × 11.5	446	B41827A4477M***
1000	10 × 16	790	B41827A4108M***

Composition of ordering code

*** = Version

000 = for standard leads, bulk

001 = for kinked leads, bulk

002 = for cut leads, bulk

 016 = for taped leads, Ammo pack, lead spacing $F = 2.0 \text{ mm}$ (for $\varnothing 5 \text{ mm}$)

 007 = for taped leads, Ammo pack, lead spacing $F = 2.5 \text{ mm}$ for $\varnothing 5 \dots 6.3 \text{ mm}$

 006 = for taped leads, Ammo pack, lead spacing $F = 3.5 \text{ mm}$ (for $\varnothing 8 \text{ mm}$)

 008 = for taped leads, Ammo pack, lead spacing $F = 5.0 \text{ mm}$ (for $\varnothing 5 \dots 12.5 \text{ mm}$)

 009 = for taped leads, Ammo pack, lead spacing $F = 7.5 \text{ mm}$ (for $d \times l = 16 \times 25 \dots 16 \times 31.5 \text{ mm}$)

Technical data and ordering codes – B41827

C_R 120 Hz, 20 °C μF	Case dimensions $d \times l$ mm	$I_{AC,R}$ 120 Hz, 85 °C mA	Ordering code (composition see below)
$V_R = 16 \text{ V DC}$			
2200	12.5 × 20	1310	B41827A4228M***
3300	12.5 × 25	1695	B41827A4338M***
4700	16 × 25	2100	B41827A4478M***
10000	18 × 35.5	2980	B41827A4109M***
$V_R = 25 \text{ V DC}$			
47	5 × 11	108	B41827A5476M***
100	6.3 × 11	192	B41827A5107M***
220	8 × 11.5	335	B41827A5227M***
330	10 × 12.5	446	B41827A5337M***
470	10 × 12.5	547	B41827A5477M***
1000	10 × 20	962	B41827A5108M***
2200	12.5 × 25	1560	B41827A5228M***
3300	16 × 25	1985	B41827A5338M***
4700	16 × 31.5	2455	B41827A5478M***
$V_R = 35 \text{ V DC}$			
33	5 × 11	102	B41827A7336M***
47	5 × 11	130	B41827A7476M***
100	6.3 × 11	212	B41827A7107M***
220	10 × 12.5	390	B41827A7227M***
330	10 × 12.5	495	B41827A7337M***
470	10 × 16	652	B41827A7477M***
1000	12.5 × 25	1158	B41827A7108M***
2200	16 × 25	1810	B41827A7228M***
3300	16 × 31.5	2293	B41827A7338M***
4700	18 × 35.5	2710	B41827A7478M***

Composition of ordering code

*** = Version

000 = for standard leads, bulk

001 = for kinked leads, bulk

002 = for cut leads, bulk

016 = for taped leads, Ammo pack, lead spacing $F = 2.0 \text{ mm}$ (for $\varnothing 5 \text{ mm}$)

007 = for taped leads, Ammo pack, lead spacing $F = 2.5 \text{ mm}$ for $\varnothing 5 \dots 6.3 \text{ mm}$)

006 = for taped leads, Ammo pack, lead spacing $F = 3.5 \text{ mm}$ (for $\varnothing 8 \text{ mm}$)

008 = for taped leads, Ammo pack, lead spacing $F = 5.0 \text{ mm}$ (for $\varnothing 5 \dots 12.5 \text{ mm}$)

009 = for taped leads, Ammo pack, lead spacing $F = 7.5 \text{ mm}$ (for $d \times l = 16 \times 25 \dots 16 \times 31.5 \text{ mm}$)

B41827
Standard series – 85 °C
Technical data and ordering codes – B41827

C_R 120 Hz, 20 °C μF	Case dimensions $d \times l$ mm	$I_{AC,R}$ 120 Hz, 85 °C mA	Ordering code (composition see below)
$V_R = 50 \text{ V DC}$			
10	5 × 11	58	B41827A6106M***
22	5 × 11	85	B41827A6226M***
33	5 × 11	117	B41827A6336M***
47	6.3 × 11	155	B41827A6476M***
100	8 × 11.5	260	B41827A6107M***
220	10 × 12.5	430	B41827A6227M***
330	10 × 16	510	B41827A6337M***
470	10 × 20	700	B41827A6477M***
1000	16 × 20	1100	B41827A6108M***
2200	16 × 31.5	1540	B41827A6228M***
$V_R = 63 \text{ V DC}$			
10	5 × 11	60	B41827A8106M***
22	6.3 × 11	100	B41827A8226M***
33	6.3 × 11	140	B41827A8336M***
47	6.3 × 11	170	B41827A8476M***
100	10 × 12.5	300	B41827A8107M***
220	10 × 20	475	B41827A8227M***
330	12.5 × 20	710	B41827A8337M***
470	12.5 × 25	900	B41827A8477M***
1000	16 × 31.5	1300	B41827A8108M***
$V_R = 100 \text{ V DC}$			
0.47	5 × 11	13	B41827A9474M***
1.0	5 × 11	20	B41827A9105M***
2.2	5 × 11	29	B41827A9225M***
3.3	5 × 11	36	B41827A9335M***
4.7	5 × 11	43	B41827A9475M***
10	6.3 × 11	75	B41827A9106M***
22	8 × 11.5	130	B41827A9226M***

Composition of ordering code

*** = Version

000 = for standard leads, bulk

001 = for kinked leads, bulk

002 = for cut leads, bulk

 016 = for taped leads, Ammo pack, lead spacing $F = 2.0 \text{ mm}$ (for $\varnothing 5 \text{ mm}$)

 007 = for taped leads, Ammo pack, lead spacing $F = 2.5 \text{ mm}$ for $\varnothing 5 \dots 6.3 \text{ mm}$)

 006 = for taped leads, Ammo pack, lead spacing $F = 3.5 \text{ mm}$ (for $\varnothing 8 \text{ mm}$)

 008 = for taped leads, Ammo pack, lead spacing $F = 5.0 \text{ mm}$ (for $\varnothing 5 \dots 12.5 \text{ mm}$)

 009 = for taped leads, Ammo pack, lead spacing $F = 7.5 \text{ mm}$ (for $d \times l = 16 \times 25 \dots 16 \times 31.5 \text{ mm}$)

Technical data and ordering codes – B41827

C_R 120 Hz, 20 °C μF	Case dimensions $d \times l$ mm	$I_{AC,R}$ 120 Hz, 85 °C mA	Ordering code (composition see below)
$V_R = 100 \text{ V DC}$			
33	10 × 12.5	180	B41827A9336M***
47	10 × 12.5	230	B41827A9476M***
100	10 × 20	370	B41827A9107M***
220	12.5 × 25	620	B41827A9227M***
330	16 × 25	760	B41827A9337M***
470	16 × 31.5	1000	B41827A9477M***
1000	18 × 40	1380	B41827A9108M***

Composition of ordering code

*** = Version

000 = for standard leads, bulk

001 = for kinked leads, bulk

002 = for cut leads, bulk

016 = for taped leads, Ammo pack, lead spacing $F = 2.0 \text{ mm}$ (for $\varnothing 5 \text{ mm}$)

007 = for taped leads, Ammo pack, lead spacing $F = 2.5 \text{ mm}$ for $\varnothing 5 \dots 6.3 \text{ mm}$)

006 = for taped leads, Ammo pack, lead spacing $F = 3.5 \text{ mm}$ (for $\varnothing 8 \text{ mm}$)

008 = for taped leads, Ammo pack, lead spacing $F = 5.0 \text{ mm}$ (for $\varnothing 5 \dots 12.5 \text{ mm}$)

009 = for taped leads, Ammo pack, lead spacing $F = 7.5 \text{ mm}$ (for $d \times l = 16 \times 25 \dots 16 \times 31.5 \text{ mm}$)

B43827
Standard series – 85 °C
Technical data and ordering codes – B43827

C_R 120 Hz, 20 °C μF	Case dimensions $d \times l$ mm	$I_{AC,R}$ 120 Hz, 85 °C mA	Ordering code (composition see below)
$V_R = 160 \text{ V DC}$			
0.47	5 × 11	15	B43827A1474M***
1.0	5 × 11	22	B43827A1105M***
2.2	5 × 11	33	B43827A1225M***
3.3	6.3 × 11	40	B43827A1335M***
4.7	6.3 × 11	49	B43827A1475M***
10	8 × 11.5	80	B43827A1106M***
22	10 × 16	152	B43827A1226M***
33	10 × 20	203	B43827A1336M***
47	12.5 × 25	268	B43827A1476M***
100	16 × 25	423	B43827A1107M***
220	16 × 35.5	786	B43827A1227M***
330	18 × 35.5	945	B43827A1337M***
$V_R = 200 \text{ V DC}$			
3.3	6.3 × 11	40	B43827A2335M***
4.7	8 × 11.5	56	B43827A2475M***
10	10 × 12.5	95	B43827A2106M***
22	10 × 20	170	B43827A2226M***
33	12.5 × 20	225	B43827A2336M***
47	12.5 × 20	267	B43827A2476M***
100	16 × 25	490	B43827A2107M***
220	18 × 35.5	815	B43827A2227M***
$V_R = 250 \text{ V DC}$			
0.47	5 × 11	15	B43827F2474M***
1.0	5 × 11	22	B43827F2105M***
2.2	6.3 × 11	33	B43827F2225M***
3.3	6.3 × 11	47	B43827F2335M***
4.7	8 × 11.5	56	B43827F2475M***
10	10 × 12.5	103	B43827F2106M***

Composition of ordering code

*** = Version

000 = for standard leads, bulk

001 = for kinked leads, bulk

002 = for cut leads, bulk

 016 = for taped leads, Ammo pack, lead spacing $F = 2.0 \text{ mm}$ (for $\varnothing 5 \text{ mm}$)

 007 = for taped leads, Ammo pack, lead spacing $F = 2.5 \text{ mm}$ for $\varnothing 5 \dots 6.3 \text{ mm}$

 006 = for taped leads, Ammo pack, lead spacing $F = 3.5 \text{ mm}$ (for $\varnothing 8 \text{ mm}$)

 008 = for taped leads, Ammo pack, lead spacing $F = 5.0 \text{ mm}$ (for $\varnothing 5 \dots 12.5 \text{ mm}$)

 009 = for taped leads, Ammo pack, lead spacing $F = 7.5 \text{ mm}$ (for $d \times l = 16 \times 25 \dots 16 \times 31.5 \text{ mm}$)

Technical data and ordering codes – B43827

C_R 120 Hz, 20 °C μF	Case dimensions $d \times l$ mm	$I_{AC,R}$ 120 Hz, 85 °C mA	Ordering code (composition see below)
$V_R = 250 \text{ V DC}$			
22	10 × 20	185	B43827F2226M***
33	12.5 × 25	225	B43827F2336M***
47	12.5 × 25	268	B43827F2476M***
100	16 × 31.5	525	B43827F2107M***
$V_R = 350 \text{ V DC}$			
1.0	6.3 × 11	22	B43827A4105M***
2.2	8 × 11.5	38	B43827A4225M***
3.3	10 × 12.5	54	B43827A4335M***
4.7	10 × 12.5	65	B43827A4475M***
10	10 × 20	115	B43827A4106M***
22	12.5 × 25	185	B43827A4226M***
33	16 × 25	276	B43827A4336M***
47	16 × 35.5	334	B43827A4476M***
100	18 × 40	510	B43827A4107M***
$V_R = 400 \text{ V DC}$			
0.47	6.3 × 11	15	B43827A9474M***
1.0	6.3 × 11	23	B43827A9105M***
2.2	8 × 11.5	40	B43827A9225M***
3.3	10 × 12.5	55	B43827A9335M***
4.7	10 × 16	67	B43827A9475M***
10	12.5 × 20	118	B43827A9106M***
22	16 × 25	200	B43827A9226M***
33	16 × 25	280	B43827A9336M***
47	16 × 35.5	362	B43827A9476M***

Composition of ordering code

*** = Version

000 = for standard leads, bulk

001 = for kinked leads, bulk

002 = for cut leads, bulk

 016 = for taped leads, Ammo pack, lead spacing $F = 2.0 \text{ mm}$ (for $\varnothing 5 \text{ mm}$)

 007 = for taped leads, Ammo pack, lead spacing $F = 2.5 \text{ mm}$ for $\varnothing 5 \dots 6.3 \text{ mm}$)

 006 = for taped leads, Ammo pack, lead spacing $F = 3.5 \text{ mm}$ (for $\varnothing 8 \text{ mm}$)

 008 = for taped leads, Ammo pack, lead spacing $F = 5.0 \text{ mm}$ (for $\varnothing 5 \dots 12.5 \text{ mm}$)

 009 = for taped leads, Ammo pack, lead spacing $F = 7.5 \text{ mm}$ (for $d \times l = 16 \times 25 \dots 16 \times 31.5 \text{ mm}$)



B43827

Standard series – 85 °C

Technical data and ordering codes – B43827

C_R 120 Hz, 20 °C μF	Case dimensions $d \times l$ mm	$I_{AC,R}$ 120 Hz, 85 °C mA	Ordering code (composition see below)
$V_R = 450 \text{ V DC}$			
0.47	8 × 11.5	18	B43827A5474M***
1.0	8 × 11.5	24	B43827A5105M***
2.2	10 × 12.5	36	B43827A5225M***
3.3	10 × 16	44	B43827A5335M***
4.7	10 × 20	56	B43827A5475M***
10	12.5 × 20	95	B43827A5106M***
22	16 × 25	170	B43827A5226M***
33	16 × 31.5	235	B43827A5336M***
47	18 × 40	302	B43827A5476M***

Composition of ordering code

*** = Version

000 = for standard leads, bulk

001 = for kinked leads, bulk

002 = for cut leads, bulk

016 = for taped leads, Ammo pack, lead spacing $F = 2.0 \text{ mm}$ (for $\varnothing 5 \text{ mm}$)

007 = for taped leads, Ammo pack, lead spacing $F = 2.5 \text{ mm}$ for $\varnothing 5 \dots 6.3 \text{ mm}$)

006 = for taped leads, Ammo pack, lead spacing $F = 3.5 \text{ mm}$ (for $\varnothing 8 \text{ mm}$)

008 = for taped leads, Ammo pack, lead spacing $F = 5.0 \text{ mm}$ (for $\varnothing 5 \dots 12.5 \text{ mm}$)

009 = for taped leads, Ammo pack, lead spacing $F = 7.5 \text{ mm}$ (for $d \times l = 16 \times 25 \dots 16 \times 31.5 \text{ mm}$)



Useful life

depending on ambient temperature T_A under ripple current operating conditions¹⁾

B41827



Useful life

depending on ambient temperature T_A under ripple current operating conditions¹⁾

B43827



1) Refer to chapter "General technical information, 5.3 Calculation of useful life" for an explanation on how to interpret the useful life graphs.



B41827, B43827

Standard series – 85 °C

Frequency factor of permissible ripple current I_{AC} versus frequency f





Taping, packing and lead configurations

Taping

Single-ended capacitors are available taped in Ammo pack from diameter 4 to 18 mm as follows:

Lead spacing $F = 2.0$ mm ($\varnothing d = 4 \dots 5$ mm)

Lead spacing $F = 2.5$ mm ($\varnothing d = 4 \dots 6.3$ mm)

Lead spacing $F = 3.5$ mm ($\varnothing d = 8$ mm)

Lead spacing $F = 5.0$ mm ($\varnothing d = 4 \dots 12.5$ mm)

Lead spacing $F = 7.5$ mm ($\varnothing d = 16 \dots 18$ mm).

Lead spacing 2.0 mm ($\varnothing d = 4 \dots 5$ mm)

Last 3 digits of ordering code: 016

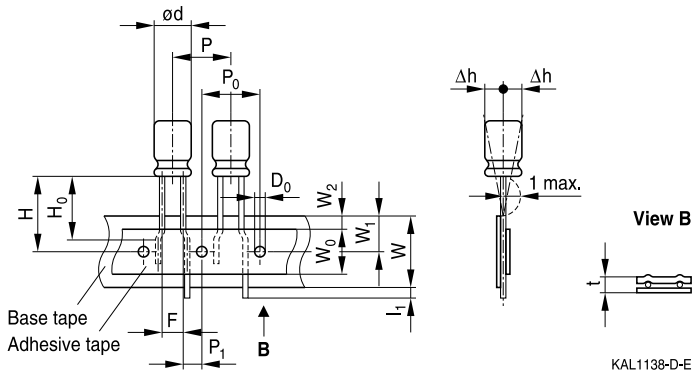

Dimensions in mm

$\varnothing d$	F	H	W	W_0	W_1	W_2	P	P_0	P_1	l_1	t	Δh	D_0
4 ... 5	2.0	18.5	18.0	7.0	9.0	3.0	12.7	12.7	5.10	1.0	0.7	1	4.0
	+0.8 -0.2	±0.75	±0.5	min.	±0.5	max.	±1.0	±0.3	±0.7	max.	±0.2	±1.0	±0.2



B41827, B43827

Standard series – 85 °C

Lead spacing 2.5 mm (∅ d = 4 ... 6.3 mm)

Last 3 digits of ordering code: 007

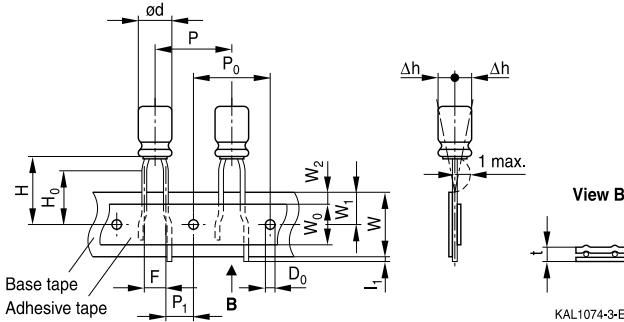

Dimensions in mm

∅ d	F	H	W	W ₀	W ₁	W ₂	H ₀	P	P ₀	P ₁	l ₁	t	Δh	D ₀
4 ... 6.3	2.5	18.5	18.0	5.5	9.0	1.5	16.0	12.7	12.7	5.1	1.0	0.7	1.0	4.0
Tolerance	+0.8 -0.2	±0.75	±0.5	min.	±0.5	max.	±0.5	±1.0	±0.2	±0.5	max.	±0.2	max.	±0.2

Lead spacing 3.5 mm (∅ d = 8 mm)

Last 3 digits of ordering code: 006

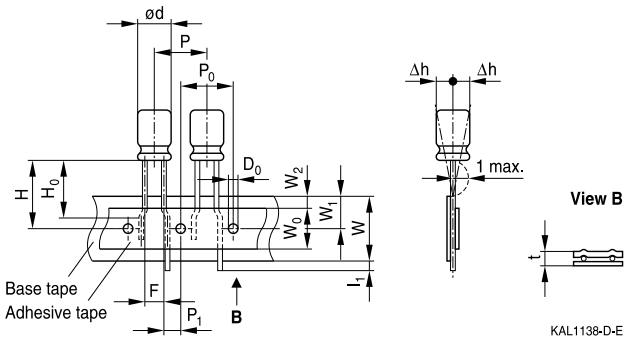

Dimensions in mm

∅ d	F	H	W	W ₀	W ₁	W ₂	P	P ₀	P ₁	l ₁	t	Δh	D ₀
8	3.5	18.5	18.0	10	9.0	3.0	12.7	12.7	4.6	1.0	0.7	1.0	4.0
Tolerance	+0.8 -0.2	±1.0	±0.5	min.	±0.5	max.	±1.0	±0.3	±0.6	max.	±0.2	max.	±0.2

Leads can also run straight through the taping area. Taping is available up to dimensions $d \times l = 8 \times 15$ mm.

Lead spacing 5.0 mm (∅ d = 4 ... 8 mm)

Last 3 digits of ordering code: 008

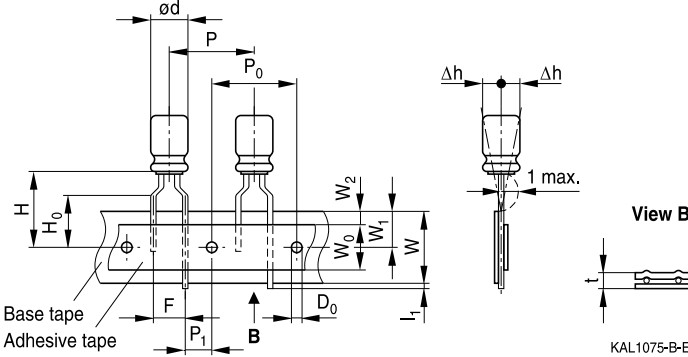
Lead spacing 5.0 mm (∅ d = 10 ... 12.5 mm)

Last 3 digits of ordering code: 008

Dimensions in mm

∅ d	F	H	W	W ₀	W ₁	W ₂	H ₀	P	P ₀	P ₁	l ₁	t	Δh	D ₀
4 ... 6.3	5.0	18.5	18.0	5.5	9.0	1.5	16.0	12.7	12.7	3.85	1.0	0.6	1.0	4.0
8	5.0	20.0	18.0	10.0	9.0	1.5	16.0	12.7	12.7	3.85	1.0	0.6	1.0	4.0
10		19.0		12.5			–	12.7	12.7	3.85				
12.5		19.0		12.5			–	15.0	15.0	5.0				
Tolerance	+0.8 –0.2	±0.75	±0.5	min.	±0.5	max.	±0.5	±1.0	±0.2	±0.5	max.	+0.3 –0.2	max.	±0.2

 Taping is available up to dimensions $d \times l = 10 \times 31.5$ mm and 12.5×25 mm.

 Taping is not available for $d \times l = 8 \times 20$ mm.



B41827, B43827

Standard series – 85 °C

Lead spacing 7.5 mm (∅ d = 16 ...18 mm)

Last 3 digits of ordering code: 009



Dimensions in mm

∅ d	F	H	W	W ₀	W ₁	W ₂	P	P ₀	P ₁	I ₁	t	ΔP	Δh	D ₀
16	7.5	18.5	18.0	12.5	9.0	1.5	30.0	15.0	3.75	1.0	0.7	0	0	4.0
18														
Tolerance	±0.8	-0.5 +0.75	±0.5	min.	±0.5	max.	±1.0	±0.2	±0.5	max.	±0.2	±1.0	±1.0	±0.2

Taping is available up to dimensions d × l = 16 × 31.5 mm and 18 × 31.5 mm.



Cut or kinked leads

Single-ended capacitors are available with cut or kinked leads. Other lead configurations also available upon request.

Cut leads (Chapter A)

Available for series B41002, B41022, B41044, B41827, B41828, B43044, B43082, B43086, B43088, B43827, B43828.

Last 3 digits of ordering code: 002

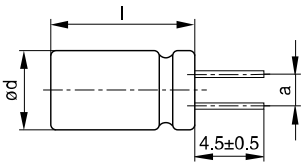

KAL1086-R

Case size d x l (mm)	Dimensions (mm) a ±0.5
4 x 7	1.5
5 x 7	2.0
5 x 11	2.0
6.3 x 7	2.5
6.3 x 11	2.5
8 x 7	3.5
8 x 11.5	3.5
8 x 15	3.5
8 x 20	3.5
10 x 12.5	5.0
10 x 16	5.0
10 x 20	5.0
10 x 25	5.0
10 x 31.5	5.0

Case size d x l (mm)	Dimensions (mm) a ±0.5
12.5 x 16	5.0
12.5 x 20	5.0
12.5 x 25	5.0
12.5 x 31.5	5.0
12.5 x 35.5	5.0
12.5 x 40	5.0
16 x 20	7.5
16 x 25	7.5
16 x 31.5	7.5
16 x 35.5	7.5
16 x 40	7.5
18 x 20	7.5
18 x 25	7.5
18 x 31.5	7.5
18 x 35.5	7.5
18 x 40	7.5



B41827, B43827

Standard series – 85 °C

Cut leads (Chapter B)

Available for series B41858, B41859, B41863, B41866, B41868, B41888, B41890, B41896, B42824, B42851, B43866, B43867, B43890, B43896.

Last 3 digits of ordering code: 002

With stand-off rubber seal

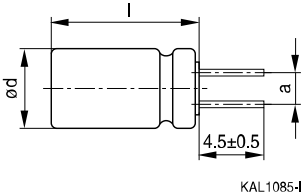

With flat rubber seal

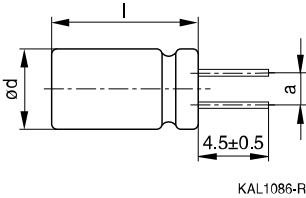

Case size d × l (mm)	Dimensions (mm) a ±0.5
10 × 12.5	5.0
10 × 16	5.0
10 × 20	5.0
12.5 × 20	5.0
12.5 × 25	5.0
16 × 20	7.5
16 × 25	7.5
16 × 31.5	7.5
16 × 35.5	7.5
18 × 20	7.5
18 × 25	7.5
18 × 31.5	7.5
18 × 35	7.5
18 × 40	7.5



Kinked leads (Chapter A)

Available for series B41002, B41022, B41044, B41827, B41828, B43044, B43082, B43086, B43088, B43827, B43828.

Last 3 digits of ordering code: 001



KAL1137-5



KAL1084-A

Case size d x l (mm)	Dimensions (mm) a ±0.5
4 x 7	1.5
5 x 7	2.0
5 x 11	2.0
6.3 x 7	2.5
6.3 x 11	2.5
8 x 7	3.5
8 x 11.5	3.5
8 x 15	3.5
8 x 20	3.5
10 x 12.5	5.0
10 x 16	5.0
10 x 20	5.0
10 x 25	5.0
10 x 31.5	5.0

Case size d x l (mm)	Dimensions (mm) a ±0.5
12.5 x 16	5.0
12.5 x 20	5.0
12.5 x 25	5.0
12.5 x 31.5	5.0
12.5 x 35.5	5.0
12.5 x 40	5.0
16 x 20	7.5
16 x 25	7.5
16 x 31.5	7.5
16 x 35.5	7.5
16 x 40	7.5
18 x 20	7.5
18 x 25	7.5
18 x 31.5	7.5
18 x 35.5	7.5
18 x 40	7.5



B41827, B43827

Standard series – 85 °C

Kinked leads (Chapter B)

Available for series B41858, B41859, B41863, B41866, B41868, B41888, B41890, B41896, B42824, B42851, B43866, B43867, B43890, B43896.

Last 3 digits of ordering code: 001

With stand-off rubber seal



KAL1081-K



KAL1083-2

With flat rubber seal



KAL1082-T



KAL1084-A

Case size d × l (mm)	Dimensions (mm) a ± 0.5
10 × 20	5.0
12.5 × 20	5.0
12.5 × 25	5.0
16 × 20	7.5
16 × 25	7.5
16 × 31.5	7.5
16 × 35.5	7.5
18 × 20	7.5
18 × 25	7.5
18 × 31.5	7.5
18 × 35	7.5
18 × 40	7.5



PAPR leads (Protection Against Polarity Reversal)

These lead configurations ensure correct placement of the capacitor on the PCB with regard to polarity. PAPR leads are available for diameters from 10 mm up to 18 mm.

There are three configurations available: Crimped leads, J leads, bent 90° leads

Available for series B41858, B41859, B41863, B41866, B41868, B41888, B41890, B41896, B42824, B42851, B43866, B43867, B43890, B43896.

Crimped leads

Last 3 digits of ordering code: 003

With stand-off rubber seal



With flat rubber seal



Suggestion for PCB hole diameter

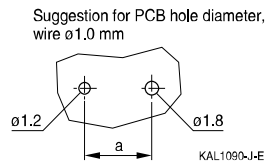
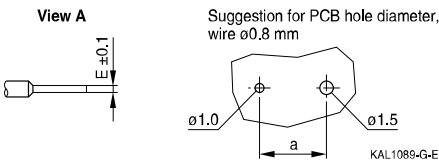

Case size d × l (mm)	Dimensions (mm)					
	B ±0.2	C ±0.5	D ±0.1	E ±0.1	a ±0.5	∅b
16 × 20	1.5	3.0	1.3	0.3	7.5	0.8 ±0.05
16 × 25	1.5	3.0	1.3	0.3	7.5	0.8 ±0.05
16 × 31.5	1.5	3.0	1.3	0.3	7.5	0.8 ±0.05
16 × 35.5	1.5	3.0	1.3	0.3	7.5	0.8 ±0.05
18 × 20	1.5	3.0	1.3	0.3	7.5	0.8 ±0.1
18 × 25	1.5	3.0	1.3	0.3	7.5	0.8 ±0.1
18 × 31.5	1.5	3.0	1.3	0.3	7.5	0.8 ±0.1
18 × 35	1.5	3.0	1.3	0.3	7.5	0.8 ±0.1
18 × 40	1.5	3.0	1.3	0.3	7.5	0.8 ±0.1



B41827, B43827

Standard series – 85 °C

J leads

Last 3 digits of ordering code: 004

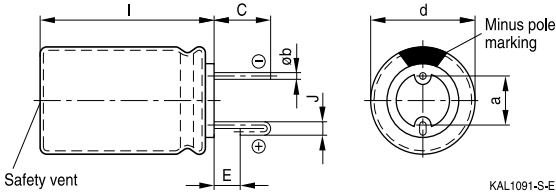

KAL1091-S-E

Suggestion for PCB hole diameter

Suggestion for PCB hole diameter,
wire $\varnothing 0.6$ mm

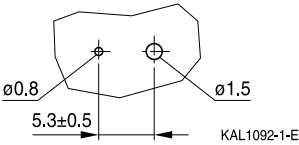

KAL1092-1-E

Suggestion for PCB hole diameter,
wire $\varnothing 0.8$ mm

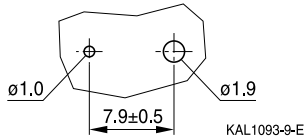

KAL1093-9-E

Case size d × l (mm)	Dimensions (mm)				
	C ±0.5	E ±0.5	J ±0.2	a ±0.5	∅b
10 × 12.5	3.2	0.7	1.2	5.0	0.6 ±0.05
10 × 16	3.2	0.7	1.2	5.0	0.6 ±0.05
10 × 20	3.2	0.7	1.2	5.0	0.6 ±0.05
12.5 × 20	3.2	0.7	1.2	5.0	0.6 ±0.05
12.5 × 25	3.2	0.7	1.2	5.0	0.6 ±0.05
16 × 20	3.5	0.7	1.6	7.5	0.8 ±0.05
16 × 25	3.5	0.7	1.6	7.5	0.8 ±0.05
16 × 31.5	3.5	0.7	1.6	7.5	0.8 ±0.05
16 × 35.5	3.5	0.7	1.6	7.5	0.8 ±0.05
18 × 20	3.5	0.7	1.6	7.5	0.8 ±0.1
18 × 25	3.5	0.7	1.6	7.5	0.8 ±0.1
18 × 31.5	3.5	0.7	1.6	7.5	0.8 ±0.1
18 × 35	3.5	0.7	1.6	7.5	0.8 ±0.1

Bent 90° leads for horizontal mounting pinning

Last 3 digits of ordering code: 012



Case size d × l (mm)	Dimensions (mm)				
	C ±0.5	E ±0.5	F ±0.5	a ±0.5	Øb
16 × 20	4.0	4.0	12.0	7.5	0.8 ±0.05
16 × 25	4.0	4.0	12.0	7.5	0.8 ±0.05
16 × 31.5	4.0	4.0	12.0	7.5	0.8 ±0.05
16 × 35.5	4.0	4.0	12.0	7.5	0.8 ±0.05
18 × 20	4.0	4.0	13.0	7.5	0.8 ±0.1
18 × 25	4.0	4.0	13.0	7.5	0.8 ±0.1
18 × 31.5	4.0	4.0	13.0	7.5	0.8 ±0.1
18 × 35	4.0	4.0	13.0	7.5	0.8 ±0.1
18 × 40	4.0	4.0	13.0	7.5	0.8 ±0.1

Bent leads for diameter 12.5 mm available upon request.



B41827, B43827

Standard series – 85 °C

Packing units and box dimensions

Ammo pack

Valid for series B41002, B41022, B41044, B41827, B41828, B43044, B43082, B43086, B43088, B43827, B43828.

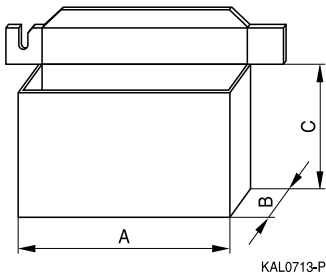

Case size d × l mm	Dimensions (mm)			Packing units pcs.
	A _{max}	B _{max}	C _{max}	
4 × 7	330	50	196	2000
5 × 7	330	50	226	2000
5 × 11	330	50	226	2000
6.3 × 7	330	50	286	2000
6.3 × 11	330	50	286	2000
8 × 7	330	50	246	1000
8 × 11.5	330	50	246	1000
8 × 15	330	50	246	500
10 × 12.5	330	50	196	500
10 × 16	330	54	196	500
10 × 20	330	58	196	500
12.5 × 20	341	60	272	500
12.5 × 25	341	65	272	500
16 × 25	320	65	270	300
16 × 31.5	315	65	275	300
18 × 20	315	65	275	250
18 × 25	315	65	275	250
18 × 31.5	315	65	275	250

Ammo pack

Valid for series B41858, B41859, B41863, B41866, B41868, B41888, B41890, B41896, B42824, B42851, B43866, B43867, B43890, B43896.

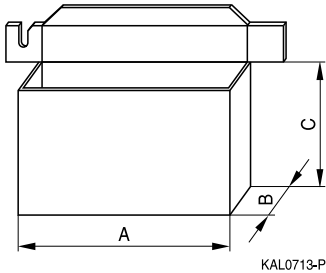

Case size d × l mm	Dimensions (mm)			Packing units pcs.
	A _{max}	B _{max}	C _{max}	
8 × 11.5	345	55	240	1000
10 × 12.5	345	55	280	750
10 × 16	345	60	200	500
10 × 20	345	60	200	500
12.5 × 20	345	65	280	500
12.5 × 25	345	65	280	500
16 × 20	315	65	275	300
16 × 25	315	65	275	300
16 × 31.5	315	65	275	300
18 × 20	315	65	275	250
18 × 25	315	65	275	250
18 × 31.5	315	65	275	250



B41827, B43827

Standard series – 85 °C

Overview of packing units and code numbers for case sizes 4 x 7 ... 16 x 40

Valid for series B41002, B41022, B41044, B41827, B41828, B43044, B43082, B43086, B43088, B43827, B43828.

Case size d x l mm	Standard, bulk pcs.	Taped, Ammo pack pcs.	Kinked leads, bulk pcs.	Cut leads, bulk pcs.		
4 x 7	10000	2000	15000	15000		
5 x 7	7500	2000	10000	10000		
5 x 11	5000	2000	10000	10000		
6.3 x 7	5000	2000	10000	10000		
6.3 x 11	5000	2000	5000	5000		
8 x 7	5000	1000	5000	5000		
8 x 11.5	2500	1000	4000	4000		
8 x 15	2000	1000	2500	2500		
8 x 20	1500	–	2000	2000		
10 x 12.5	2000	500	2500	2500		
10 x 16	1500	500	2000	2000		
10 x 20	1000	500	1500	1500		
10 x 25	1000	500	1250	1250		
12.5 x 16	750	500	1000	1000		
12.5 x 20	750	500	500	500		
12.5 x 25	750	500	500	500		
12.5 x 31.5	500	–	750	750		
12.5 x 35.5	500	–	750	750		
12.5 x 40	500	–	750	750		
16 x 20	375	300	500	500		
16 x 25	375	300	500	500		
16 x 31.5	250	300	375	375		
16 x 35.5	250	–	375	375		
16 x 40	250	–	375	375		
The last three digits of the complete ordering code state the lead configuration	000	Code	F (mm)	d (mm)	001	002
		006	3.5	8		
		007	2.5	4 ... 6.3		
		008	5.0	4 ... 12.5		
		009	7.5	16 ... 18		
		016	2.0	4 ... 5		

Overview of packing units and code numbers for case sizes 18 x 20 ... 18 x 40

Valid for series B41002, B41022, B41044, B41827, B41828, B43044, B43082, B43086, B43088, B43827, B43828.

Case size d x l mm	Standard, bulk pcs.	Taped, Ammo pack pcs.			Kinked leads, bulk pcs.	Cut leads, bulk pcs.
18 x 20	250	250			100	100
18 x 25	250	250			100	100
18 x 31.5	250	250			100	100
18 x 35.5	250	–			100	100
18 x 40	250	–			100	100
The last three digits of the complete ordering code state the lead configuration	000	Code	F (mm)	d (mm)	001	002
		009	7.5	16 ... 18		



B41827, B43827

Standard series – 85 °C

Overview of packing units and code numbers for case sizes 8 × 11.5 ... 16 × 35.5

Valid for series B41858, B41859, B41863, B41866, B41868, B41888, B41890, B41896, B42824, B42851, B43866, B43867, B43890, B43896.

					PAPR				
Case size d × l	Stan- dard, bulk	Taped, Ammo pack			Kinked leads, bulk	Cut leads, bulk	Crimped leads, blister	J leads, blister	Bent 90° leads, blister
mm	pcs.	pcs.		pcs.	pcs.	pcs.	pcs.	pcs.	
8 × 11.5	1000	1000		–	–	–	–		
10 × 12.5	1000	750		–	1000	–	675		
10 × 16	1000	500		–	1000	–	675		
10 × 20	500	500		500	500	–	500		
12.5 × 20	350	500		350	350	–	300	1)	
12.5 × 25	250	500		500	500	–	225	1)	
12.5 × 30	200	–		–	–	–	–		
12.5 × 35	175	–		–	–	–	–		
12.5 × 40	175	–		–	–	–	–		
16 × 20	250	300		200	200	200	200	120	
16 × 25	250	300		200	200	200	200	120	
16 × 31.5	200	300		250	250	344	344	120	
16 × 35.5	100	–		100	100	150	150	150	
The last three digits of the complete ordering code state the lead configuration	000	Code	F (mm)	d (mm)	001	002	003	004	012
		006	3.5	8					
		008	5	5...12.5					
		009	7.5	16...18					

1) Available upon request

Overview of packing units and code numbers for case sizes 18 × 20 ... 18 × 40

Valid for series B41858, B41859, B41863, B41866, B41868, B41888, B41890, B41896, B42824, B42851, B43866, B43867, B43890, B43896.

					PAPR				
Case size d × l mm	Standard, bulk pcs.	Taped, Ammo pack pcs.			Kinked leads, bulk pcs.	Cut leads, bulk pcs.	Crimped leads, blister pcs.	J leads, blister pcs.	Bent 90° leads, blister pcs.
18 × 20	175	250			175	175	200	200	120
18 × 25	150	250			150	150	200	200	120
18 × 31.5	100	250			100	100	150	150	120
18 × 35	100	–			100	100	150	150	150
18 × 40	125	–			100	100	120	–	72
The last three digits of the complete ordering code state the lead configuration	000	Code	F (mm)	d (mm)	001	002	003	004	012
		009	7.5	16...18					

**B41827, B43827****Standard series – 85 °C**

Cautions and warnings

Personal safety

The electrolytes used by EPCOS have not only been optimized with a view to the intended application, but also with regard to health and environmental compatibility. They do not contain any solvents that are detrimental to health, e.g. dimethyl formamide (DMF) or dimethyl acetamide (DMAC).

Furthermore, part of the high-voltage electrolytes used by EPCOS are self-extinguishing. They contain flame-retarding substances which will quickly extinguish any flame that may have been ignited.

As far as possible, EPCOS does not use any dangerous chemicals or compounds to produce operating electrolytes. However, in exceptional cases, such materials must be used in order to achieve specific physical and electrical properties because no safe substitute materials are currently known. However, the amount of dangerous materials used in our products has been limited to an absolute minimum. Nevertheless, the following rules should be observed when handling aluminum electrolytic capacitors:

- Any escaping electrolyte should not come into contact with eyes or skin.
- If electrolyte does come into contact with the skin, wash the affected parts immediately with running water. If the eyes are affected, rinse them for 10 minutes with plenty of water. If symptoms persist, seek medical treatment.
- Avoid breathing in electrolyte vapor or mists. Workplaces and other affected areas should be well ventilated. Clothing that has been contaminated by electrolyte must be changed and rinsed in water.



Product safety

The table below summarizes the safety instructions that must be observed without fail. A detailed description can be found in the relevant sections of chapter "General technical information".

Topic	Safety information	Reference chapter "General technical information"
Polarity	Make sure that polar capacitors are connected with the right polarity.	1 "Basic construction of aluminum electrolytic capacitors"
Reverse voltage	Voltages polarity classes should be prevented by connecting a diode.	3.1.6 "Reverse voltage"
Upper category temperature	Do not exceed the upper category temperature.	7.2 "Maximum permissible operating temperature"
Maintenance	Make periodic inspections of the capacitors. Before the inspection, make sure that the power supply is turned off and carefully discharge the electricity of the capacitors. Do not apply any mechanical stress to the capacitor terminals.	10 "Maintenance"
Mounting position of screw-terminal capacitors	Do not mount the capacitor with the terminals (safety vent) upside down.	11.1. "Mounting positions of capacitors with screw terminals"
Mounting of single-ended capacitors	The internal structure of single-ended capacitors might be damaged if excessive force is applied to the lead wires. Avoid any compressive, tensile or flexural stress. Do not move the capacitor after soldering to PC board. Do not pick up the PC board by the soldered capacitor. Do not insert the capacitor on the PC board with a hole space different to the lead space specified.	11.4 "Mounting considerations for single-ended capacitors"
Robustness of terminals	The following maximum tightening torques must not be exceeded when connecting screw terminals: M5: 2 Nm M6: 2.5 Nm	11.3 "Mounting torques"
Soldering	Do not exceed the specified time or temperature limits during soldering.	11.5 "Soldering"



B41827, B43827

Standard series – 85 °C

Topic	Safety information	Reference chapter "General technical information"
Soldering, cleaning agents	Do not allow halogenated hydrocarbons to come into contact with aluminum electrolytic capacitors.	11.6 "Cleaning agents"
Passive flammability	Avoid external energy, such as fire or electricity.	8.1 "Passive flammability"
Active flammability	Avoid overload of the capacitors.	8.2 "Active flammability"
		Reference chapter "Capacitors with screw terminals"
Breakdown strength of insulating sleeves	Do not damage the insulating sleeve, especially when ring clips are used for mounting.	"Screw terminals – accessories"

Symbols and terms

Symbol	English	German
C	Capacitance	Kapazität
C_R	Rated capacitance	Nennkapazität
C_S	Series capacitance	Serienkapazität
$C_{S,T}$	Series capacitance at temperature T	Serienkapazität bei Temperatur T
C_f	Capacitance at frequency f	Kapazität bei Frequenz f
d	Case diameter, nominal dimension	Gehäusedurchmesser, Nennmaß
d_{max}	Maximum case diameter	Maximaler Gehäusedurchmesser
ESL	Self-inductance	Eigeninduktivität
ESR	Equivalent series resistance	Ersatzserienwiderstand
ESR_f	Equivalent series resistance at frequency f	Ersatzserienwiderstand bei Frequenz f
ESR_T	Equivalent series resistance at temperature T	Ersatzserienwiderstand bei Temperatur T
f	Frequency	Frequenz
I	Current	Strom
I_{AC}	Alternating current (ripple current)	Wechselstrom
$I_{AC,rms}$	Root-mean-square value of alternating current	Wechselstrom, Effektivwert
$I_{AC,f}$	Ripple current at frequency f	Wechselstrom bei Frequenz f
$I_{AC,max}$	Maximum permissible ripple current	Maximal zulässiger Wechselstrom
$I_{AC,R}$	Rated ripple current	Nennwechselstrom
$I_{AC,R} (B)$	Rated ripple current for base cooling	Nennwechselstromstrom für Bodenkühlung
I_{leak}	Leakage current	Reststrom
$I_{leak,op}$	Operating leakage current	Betriebsreststrom
l	Case length, nominal dimension	Gehäuselänge, Nennmaß
l_{max}	Maximum case length (without terminals and mounting stud)	Maximale Gehäuselänge (ohne Anschlüsse und Gewindebolzen)
R	Resistance	Widerstand
R_{ins}	Insulation resistance	Isolationswiderstand
R_{symm}	Balancing resistance	Symmetrierwiderstand
T	Temperature	Temperatur
ΔT	Temperature difference	Temperaturdifferenz
T_A	Ambient temperature	Umgebungstemperatur
T_C	Case temperature	Gehäusetemperatur
T_B	Capacitor base temperature	Temperatur des Becherbodens
t	Time	Zeit
Δt	Period	Zeitraum
t_b	Service life (operating hours)	Brauchbarkeitsdauer (Betriebszeit)

B41827, B43827
Standard series – 85 °C

Symbol	English	German
V	Voltage	Spannung
V _F	Forming voltage	Formierspannung
V _{op}	Operating voltage	Betriebsspannung
V _R	Rated voltage, DC voltage	Nennspannung, Gleichspannung
V _S	Surge voltage	Spitzenspannung
X _C	Capacitive reactance	Kapazitiver Blindwiderstand
X _L	Inductive reactance	Induktiver Blindwiderstand
Z	Impedance	Scheinwiderstand
Z _T	Impedance at temperature T	Scheinwiderstand bei Temperatur T
tan δ	Dissipation factor	Verlustfaktor
λ	Failure rate	Ausfallrate
ε ₀	Absolute permittivity	Elektrische Feldkonstante
ε _r	Relative permittivity	Dielektrizitätszahl
ω	Angular velocity; $2 \cdot \pi \cdot f$	Kreisfrequenz; $2 \cdot \pi \cdot f$

Note

All dimensions are given in mm.

Important notes

The following applies to all products named in this publication:

1. Some parts of this publication contain **statements about the suitability of our products for certain areas of application**. These statements are based on our knowledge of typical requirements that are often placed on our products in the areas of application concerned. We nevertheless expressly point out **that such statements cannot be regarded as binding statements about the suitability of our products for a particular customer application**. As a rule, EPCOS is either unfamiliar with individual customer applications or less familiar with them than the customers themselves. For these reasons, it is always ultimately incumbent on the customer to check and decide whether an EPCOS product with the properties described in the product specification is suitable for use in a particular customer application.
2. We also point out that **in individual cases, a malfunction of electronic components or failure before the end of their usual service life cannot be completely ruled out in the current state of the art, even if they are operated as specified**. In customer applications requiring a very high level of operational safety and especially in customer applications in which the malfunction or failure of an electronic component could endanger human life or health (e.g. in accident prevention or lifesaving systems), it must therefore be ensured by means of suitable design of the customer application or other action taken by the customer (e.g. installation of protective circuitry or redundancy) that no injury or damage is sustained by third parties in the event of malfunction or failure of an electronic component.
3. **The warnings, cautions and product-specific notes must be observed.**
4. In order to satisfy certain technical requirements, **some of the products described in this publication may contain substances subject to restrictions in certain jurisdictions (e.g. because they are classed as hazardous)**. Useful information on this will be found in our Material Data Sheets on the Internet (www.epcos.com/material). Should you have any more detailed questions, please contact our sales offices.
5. We constantly strive to improve our products. Consequently, **the products described in this publication may change from time to time**. The same is true of the corresponding product specifications. Please check therefore to what extent product descriptions and specifications contained in this publication are still applicable before or when you place an order. We also **reserve the right to discontinue production and delivery of products**. Consequently, we cannot guarantee that all products named in this publication will always be available. The aforementioned does not apply in the case of individual agreements deviating from the foregoing for customer-specific products.
6. Unless otherwise agreed in individual contracts, **all orders are subject to the current version of the "General Terms of Delivery for Products and Services in the Electrical Industry" published by the German Electrical and Electronics Industry Association (ZVEI)**.
7. The trade names EPCOS, BAOKE, Alu-X, CeraDiode, CSMP, CSSP, CTVS, DeltaCap, DigiSiMic, DSSP, FormFit, MiniBlue, MiniCell, MKK, MKD, MLSC, MotorCap, PCC, PhaseCap, PhaseCube, PhaseMod, PhiCap, SIFERRIT, SIFI, SIKOREL, SilverCap, SIMDAD, SiMic, SIMID, SineFormer, SIOV, SIP5D, SIP5K, ThermoFuse, WindCap are **trade-marks registered or pending** in Europe and in other countries. Further information will be found on the Internet at www.epcos.com/trademarks.