

LL grade

High reliability and long useful life

For professional industrial electronics equipment

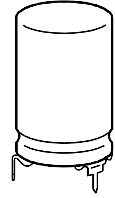

KAL0276-R

Construction

- Charge-discharge proof, polar
- Aluminum case, partially insulated
- Solder pin terminals on mounting base that is securely welded to case, ensuring perfect electrical contact
- Positive pole connection brought out axially at center
- Negative pole connected to two or three solder pins of the mounting base

Features

- High reliability and long useful life
- High vibration resistance
- Pinning ensures correct insertion
- High parametric stability
- Type B 41 783 can be operated at temperatures of up to 125 °C¹⁾

Applications

- Professional industrial electronics equipment
- Filtering, coupling and pulse circuits
- Automotive electronics

Specifications and characteristics in brief

	B 41 783	B 43 783
Rated voltage U_R	10 ... 100 V–	160 ... 450 V–
Surge voltage U_S	$1,15 \cdot U_R$	$1,15 \cdot U_R$ (for $U_R \leq 250$ V–) $1,10 \cdot U_R$ (for $U_R \geq 350$ V–)
Rated capacitance C_R	47 ... 10 000 μ F	6,8 ... 220 μ F
Capacitance tolerance	– 10/+ 50 % \triangleq T	– 10/+ 50 % \triangleq T
Useful life		
40 °C, U_R	> 200 000 h ($2,0 \cdot I_{-R,105^\circ\text{C}}$)	> 200 000 h ($1,7 \cdot I_{-R,105^\circ\text{C}}$)
85 °C, U_R ; I_{-max}	> 10 000 h	> 8 000 h
105 °C, U_R ; I_{-R}	> 2 500 h	> 2 000 h
Failure percentage	$\leq 0,5$ % (during useful life)	$\leq 0,5$ % (during useful life)
Failure rate	≤ 20 fit ($\leq 20 \cdot 10^{-9}$ /h)	≤ 20 fit ($\leq 20 \cdot 10^{-9}$ /h)
Voltage endurance test	2 000 h, 105 °C (at U_R)	2 000 h, 105 °C (at U_R)

1) Operation at 125 °C and $0,6 \cdot I_{-max,105^\circ\text{C}}$ for a total of 100 h

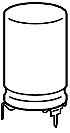

B 41 783
B 43 783

Specifications and characteristics in brief

	B 41 783		B 43 783		
Leakage current I_{lka} (5 min, 20 °C)	$I_{lka} \leq 0,3 \mu\text{A} \cdot \left(\frac{C_R}{\mu\text{F}} \cdot \frac{U_R}{\text{V}} \right)^{0,7} + 4 \mu\text{A}$				
Self-inductance L_{ESL}	Diam. d	12 mm	14 mm	16 mm	18 mm
	Length l	Approx. L_{ESL} (nH)			
	20 mm	6	–	–	–
	25 mm	7	8	–	–
	30 mm	8	9	10	–
	39 mm	–	–	11	14
IEC climatic category	in accordance with IEC 68–1 25/105/56 (–25 °C/+105 °C, 56 days damp heat test)				
Detail specification	similar to CECC 30 301-049				
Sectional specification	IEC 384–4				
Vibration resistance	in accordance with IEC 68–2–6, test Fc: displacement amplitude 0,75 mm, frequency range 10 ... 55 Hz, acceleration max. 10 g, duration 3 × 2 h				

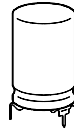

Dimensional drawing

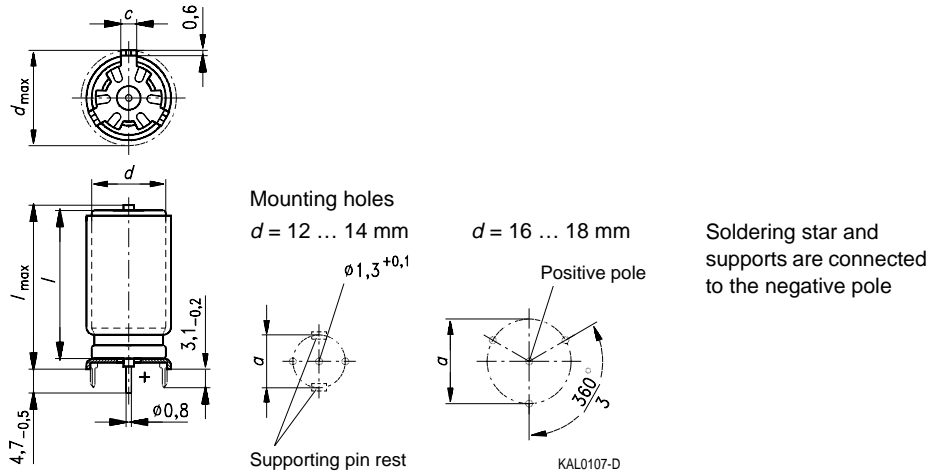

Dimensions (mm)				Approx weight (g)	Packing units (pieces)
$d \times l$	$d_{\max} \times l_{\max}$	$a \pm 0,1$	$c \pm 0,1$		
12 × 20	13,5 × 22,5	12,5	3,0	3,8	640
12 × 25	13,5 × 27	12,5		4,5	480
12 × 30	13,5 × 32	12,5		5,4	480
14 × 25	15,5 × 27	14,5		6,1	480
14 × 30	15,5 × 32	14,5		7,2	480
16 × 30	17,5 × 32	16,5		9,4	300
16 × 39	17,5 × 41,5	16,5		12,2	200
18 × 39	19,5 × 41,5	18,5	15,4	200	

The PC-board hole arrangement specified above is based on circular arcs.

If, however, the mounting holes have to be matched to a standard drilling raster, a spacing of 1,27 mm ($1/20''$) has proved to be sufficiently accurate if the following arrangements are used:

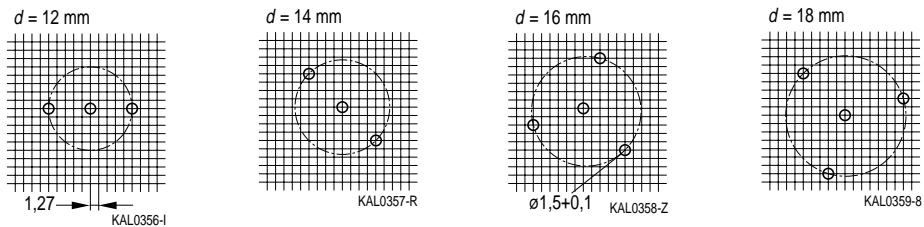

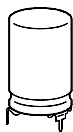

B 41 783
B 43 783

Overview of available types

Type B 41 783

U_R (V-)	10	16	25	40	63	100
C_R (μ F)	Case dimensions $d \times l$ (mm)					
47						12 × 20
68						12 × 20
100					12 × 20	12 × 25
150					12 × 20	12 × 30
220			12 × 20	12 × 20	12 × 25	14 × 30
330			12 × 20	12 × 20	14 × 25	16 × 30
470	12 × 20	12 × 20	12 × 20	12 × 25	14 × 30	16 × 39
560						18 × 39
680	12 × 20		12 × 25	12 × 30	16 × 30	
1 000	12 × 20	12 × 20	12 × 30	14 × 30	18 × 39	
1 500	12 × 25	12 × 30	14 × 30	16 × 30		
2 200	12 × 30	14 × 30	16 × 30	16 × 39		
3 300	14 × 30	16 × 30	16 × 39			
4 700	14 × 30	16 × 39	18 × 39			
6 800	16 × 30	18 × 39				
10 000	18 × 39					

Type B 43 783

U_R (V-)	160	250	350	400	450
C_R (μ F)	Case dimensions $d \times l$ (mm)				
6,8					12 × 20
10			12 × 20	12 × 20	12 × 25
15		12 × 20			
22	12 × 20	12 × 25	12 × 30	14 × 25	14 × 30
33	12 × 20	12 × 30	14 × 30	16 × 30	16 × 30
47	12 × 25	14 × 25	16 × 30	16 × 39	16 × 39
68				18 × 39	18 × 39
100	14 × 30	16 × 39	18 × 39		
150		18 × 39			
220	16 × 39				

The above capacitance and voltage ratings are available in different cases upon request. Other capacitance and voltage ratings are also available upon request.

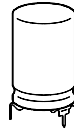

Technical data and ordering codes

U_R	C_R	Case dimensions $d \times l$ mm	$R_{ESR, \max}$ 100 Hz 20 °C mΩ	Z_{\max} 20 kHz 20 °C mΩ	$I_{\sim \max}$ 100 Hz 40 °C A	$I_{\sim \max}$ 100 Hz 85 °C A	$I_{\sim R}$ 100 Hz 105 °C A	Ordering code ¹⁾ Short code
B41783-								
10	470	12 × 20	650	540	1,9	1,3	0,60	-A3477-T
	680	12 × 20	500	400	2,2	1,5	0,70	-A3687-T
	1 000	12 × 20	550	450	2,2	1,5	0,70	-A3108-T
	1 500	12 × 25	370	300	2,9	2,0	0,95	-A3158-T
	2 200	12 × 30	250	210	4,0	2,8	1,3	-A3228-T
	3 300	14 × 30	170	145	5,0	3,4	1,6	-A3338-T
	4 700	14 × 30	150	130	5,3	3,7	1,7	-A3478-T
	6 800	16 × 30	105	80	7,4	5,2	2,4	-A3688-T
	10 000	18 × 39	65	55	9,6	6,7	3,1	-A3109-T
16	470	12 × 20	460	390	2,0	1,4	0,65	-A4477-T
	1 000	12 × 20	430	375	2,3	1,6	0,75	-A4108-T
	1 500	12 × 30	265	235	3,4	2,4	1,1	-A4158-T
	2 200	14 × 30	180	160	4,0	2,8	1,3	-A4228-T
	3 300	16 × 30	120	110	5,3	3,7	1,7	-A4338-T
	4 700	16 × 39	90	80	6,2	4,3	2,0	-A4478-T
	6 800	18 × 39	65	60	9,3	6,5	3,0	-A4688-T
	25	220	12 × 20	550	380	1,7	1,2	0,55
330		12 × 20	450	350	2,0	1,4	0,65	-A5337-T
470		12 × 20	500	430	2,0	1,4	0,65	-A5477-T
680		12 × 25	350	300	2,5	1,7	0,80	-A5687-T
1 000		12 × 30	240	210	3,1	2,2	1,0	-A5108-T
1 500		14 × 30	165	145	3,7	2,6	1,2	-A5158-T
2 200		16 × 30	115	105	4,3	3,0	1,4	-A5228-T
3 300		16 × 39	80	75	5,9	4,1	1,9	-A5338-T
4 700		18 × 39	60	55	8,1	5,6	2,6	-A5478-T

1) To obtain the required ordering code, prefix the type number to the short code. E. g.: B41783-A3477-T

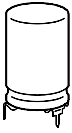

B 41 783
B 43 783

Technical data and ordering codes

U_R	C_R	Case dimensions $d \times l$ mm	$R_{ESR, \max}$ 100 Hz 20 °C mΩ	Z_{\max} 20 kHz 20 °C mΩ	$I_{\sim \max}$ 100 Hz 40 °C A	$I_{\sim \max}$ 100 Hz 85 °C A	$I_{\sim R}$ 100 Hz 105 °C A	Ordering code ¹⁾ Short code
B41783-								
40	220	12 × 20	500	350	1,7	1,2	0,55	-A7227-T
	330	12 × 20	450	370	2,0	1,4	0,65	-A7337-T
	470	12 × 25	320	260	2,5	1,7	0,80	-A7477-T
	680	12 × 30	250	210	3,1	2,2	1,0	-A7687-T
	1 000	14 × 30	160	135	4,0	2,8	1,3	-A7108-T
	1 500	16 × 30	120	100	5,3	3,7	1,7	-A7158-T
	2 200	16 × 39	80	65	6,8	4,7	2,2	-A7228-T
63	100	12 × 20	830	690	1,2	0,90	0,40	-A8107-T
	150	12 × 20	600	500	1,4	1,0	0,45	-A8157-T
	220	12 × 25	410	320	2,0	1,4	0,65	-A8227-T
	330	14 × 25	280	220	2,6	1,8	0,85	-A8337-T
	470	14 × 30	210	170	3,4	2,4	1,1	-A8477-T
	680	16 × 30	145	130	4,3	3,0	1,4	-A8687-T
	1 000	18 × 39	95	75	6,2	4,3	2,0	-A8108-T
100	47	12 × 20	1100	850	0,80	0,60	0,27	-A9476-T
	68	12 × 20	880	600	0,90	0,60	0,30	-A9686-T
	100	12 × 25	600	420	1,4	1,0	0,45	-A9107-T
	150	12 × 30	430	310	1,9	1,3	0,60	-A9157-T
	220	14 × 30	280	200	2,5	1,7	0,80	-A9227-T
	330	16 × 30	190	140	3,1	2,2	1,0	-A9337-T
	470	16 × 39	135	95	4,3	3,0	1,4	-A9477-T
	560	18 × 39	110	80	5,0	3,4	1,6	-A9567-T

1) To obtain the required ordering code, prefix the type number to the short code. E. g.: B41783-A7227-T

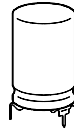

Technical data and ordering codes

U_R	C_R	Case dimensions $d \times l$ mm	$R_{ESR, \max}$ 100 Hz 20 °C mΩ	Z_{\max} 20 kHz 20 °C mΩ	$I_{\sim \max}$ 100 Hz 40 °C A	$I_{\sim \max}$ 100 Hz 85 °C A	$I_{\sim R}$ 100 Hz 105 °C A	Ordering code ¹⁾ Short code
B43783-								
160	22	12 × 20	7000	5000	0,47	0,30	0,15	-A1226-T
	33	12 × 20	4700	3700	0,57	0,36	0,18	-A1336-T
	47	12 × 25	3200	2300	0,72	0,46	0,23	-A1476-T
	100	14 × 30	1500	1100	1,3	0,80	0,40	-A1107-T
	220	16 × 39	700	500	2,4	1,5	0,75	-A1227-T
250	15	12 × 20	9000	6500	0,38	0,24	0,12	-A2156-T
	22	12 × 25	6200	4400	0,54	0,34	0,17	-A2226-T
	33	12 × 30	4200	3000	0,66	0,42	0,21	-A2336-T
	47	14 × 25	3000	2100	0,79	0,50	0,25	-A2476-T
	100	16 × 39	1400	1000	1,6	1,0	0,50	-A2107-T
	150	18 × 39	950	700	2,1	1,3	0,65	-A2157-T
350	10	12 × 20	11500	7000	0,35	0,22	0,11	-A4106-T
	22	12 × 30	5200	3200	0,63	0,40	0,20	-A4226-T
	33	14 × 30	3500	2200	0,82	0,52	0,26	-A4336-T
	47	16 × 30	2300	1500	1,0	0,66	0,33	-A4476-T
	100	18 × 39	1100	700	1,9	1,2	0,60	-A4107-T
400	10	12 × 20	11000	7000	0,35	0,22	0,11	-A9106-T
	22	14 × 25	5000	2800	0,63	0,40	0,20	-A9226-T
	33	16 × 30	3400	1900	0,88	0,56	0,28	-A9336-T
	47	16 × 39	2200	1400	1,3	0,80	0,40	-A9476-T
	68	18 × 39	1600	1050	1,6	1,0	0,50	-A9686-T
450	6,8	12 × 20	19000	14000	0,28	0,18	0,09	-A5685-T
	10	12 × 25	13000	9000	0,38	0,24	0,12	-A5106-T
	22	14 × 30	6000	4100	0,63	0,40	0,20	-A5226-T
	33	16 × 30	4000	2700	0,88	0,56	0,28	-A5336-T
	47	16 × 39	2700	1900	1,2	0,76	0,38	-A5476-T
	68	18 × 39	2000	1300	1,5	0,96	0,48	-A5686-T

1) To obtain the required ordering code, prefix the type number to the short code. E. g.: B43783-A1226-T

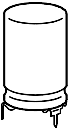

B 41 783
B 43 783

Useful life

versus ambient temperature T_A under ripple current operating conditions ¹⁾

$U_R = 10 \dots 100 \text{ V-}$

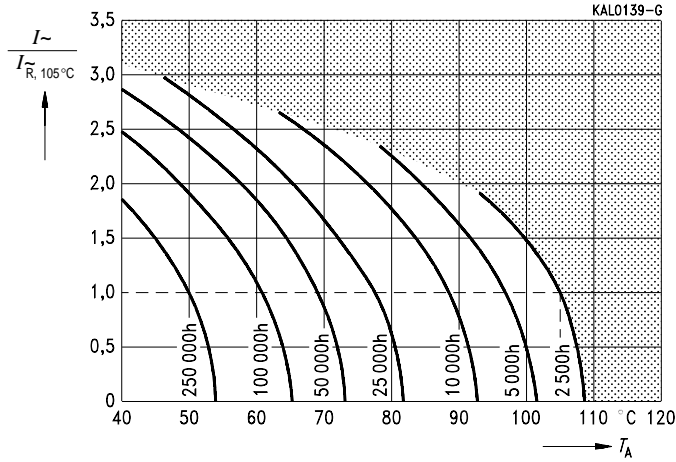

$U_R = 160 \dots 450 \text{ V-}$

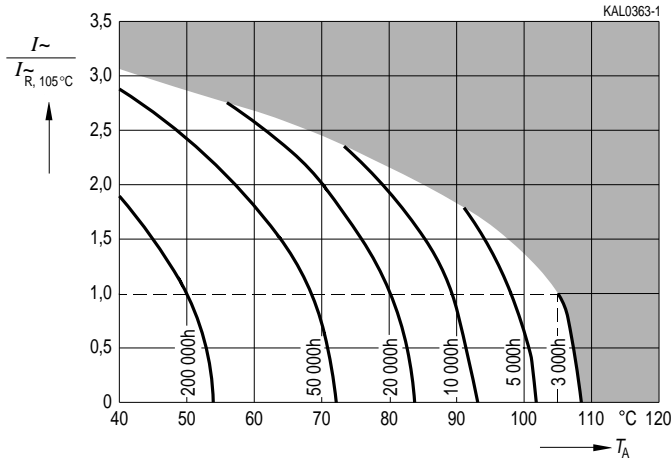

1) Refer to [page 34](#) for an explanation on how to interpret the useful life graphs.

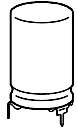

Permissible ripple current I_r
versus frequency f
 $U_R \leq 100 \text{ V}$ –

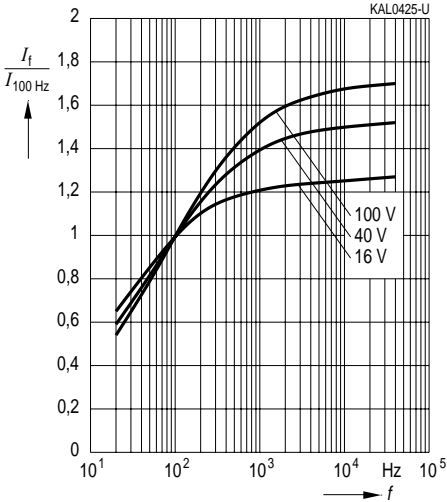

Permissible ripple current I_r
versus frequency f
 $U_R \geq 160 \text{ V}$ –

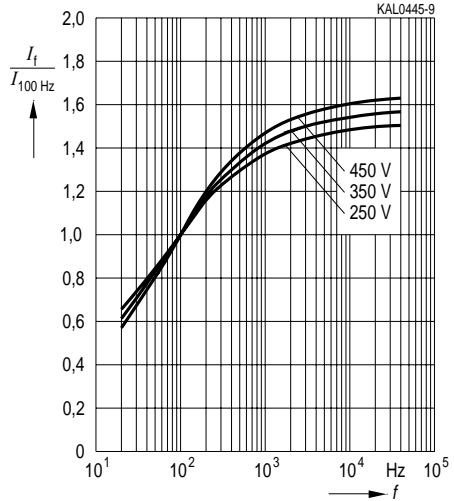

Series capacitance C_s at $f = 100 \text{ Hz}$
versus temperature T
Typical behavior
 $U_R \leq 100 \text{ V}$ –

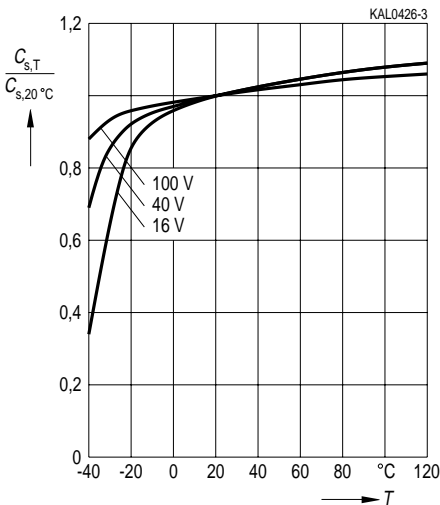

Series capacitance C_s at $f = 100 \text{ Hz}$
versus temperature T
Typical behavior
 $U_R \geq 160 \text{ V}$ –

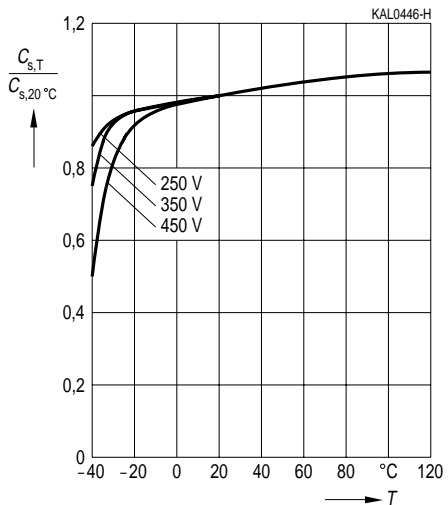

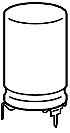

B 41 783
B 43 783

Equivalent series resistance R_{ESR}

at $f = 100$ Hz versus temperature T

Typical behavior

$U_R \leq 100$ V-

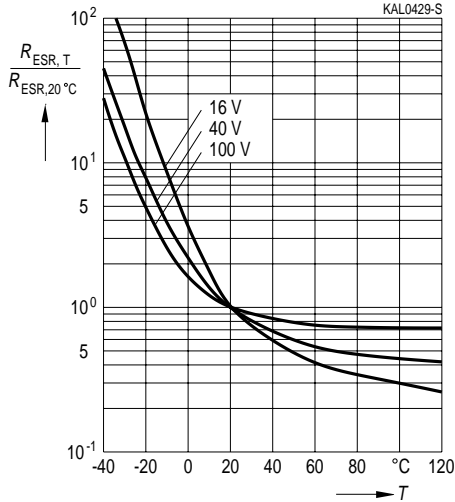

Impedance Z at $f = 100$ Hz

versus temperature T

Typical behavior

$U_R \geq 160$ V-

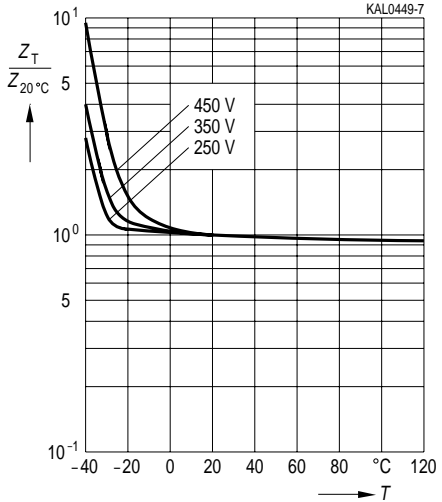

Impedance Z at $f = 20$ kHz

versus temperature T

Typical behavior

$U_R \leq 100$ V-

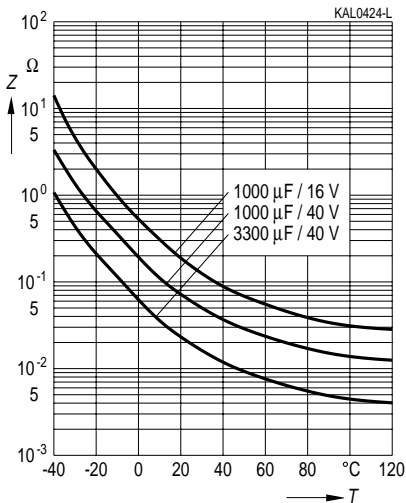

Impedance Z at $f = 20$ kHz

versus temperature T for $47 \mu F$

Typical behavior

$U_R \geq 160$ V-

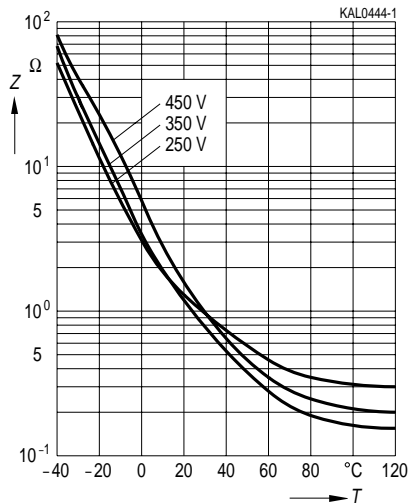

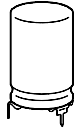

Impedance Z

versus frequency f
and temperature T for 1000 $\mu\text{F}/40\text{ V}$ –
Typical behavior

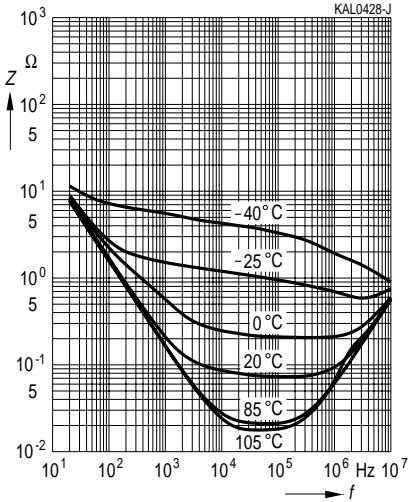

Impedance Z

versus frequency f
and temperature T for 47 $\mu\text{F}/450\text{ V}$ –
Typical behavior

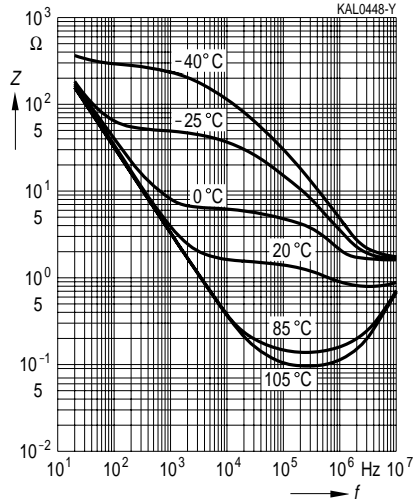

Impedance Z

versus frequency f
Typical values at 20 °C
 $U_R \leq 100\text{ V}$ –

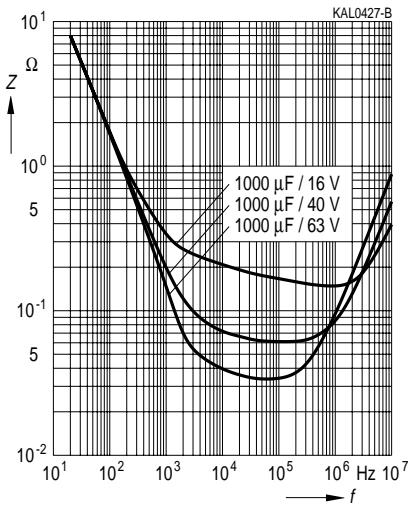

Impedance Z

versus frequency f for 47 μF
Typical values at 20 °C
 $U_R \geq 160\text{ V}$ –

