



Aluminum electrolytic capacitors

Axial-lead and soldering star capacitors

Series/Type: B41690, B41790

Date: February 2011

Applications

- Ultra compact design for automotive applications up to 140 °C

Features

- Up to 150 °C operating temperature at reduced voltage applied
- Long useful life, 2000 h at up to 140 °C
- Very high ripple current capability
- Ultra compact design
- High vibration resistance
- Shelf life up to 15 years at storage temperatures up to 40 °C.
To ensure solderability, the capacitors should be built into the application within one year of delivery. After a total of two years' storage, the operating voltage must be applied for one hour to ensure the specified leakage current.

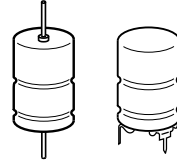

Construction

- Charge/discharge-proof, polar
- Aluminum case with insulating sleeve
- Negative pole connected to case

Terminals

- Axial leads, welded to ensure perfect electrical contact
- Also available with soldering stars

Taping and packing

- Axial-lead capacitors will be delivered in pallet package.
Capacitors with $d \times l \leq 16 \times 30$ mm are also available taped on reel.
- Soldering star capacitors are packed in cardboard.

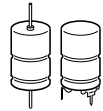
Specifications and characteristics in brief

Rated voltage V_R	25 ... 63 V DC						
Surge voltage V_S	1.3 · V_R (for $V_R \leq 40$ V DC) 1.15 · V_R (for $V_R = 63$ V DC)						
Rated capacitance C_R	300 ... 10000 μF						
Capacitance tolerance	–10/+30% \triangleq Q						
Leakage current I_{leak} (5 min, 20 °C)	$I_{\text{leak}} \leq 0.006 \mu\text{A} \cdot \left(\frac{C_R}{\mu\text{F}} \cdot \frac{V_R}{V} \right) + 4 \mu\text{A}$						
Self-inductance ESL ¹⁾	Diameter d (mm)	12	14	16	18	20/21	
	Terminals	Length l (mm)					Approx. ESL (nH)
	axial	25	–	22	26	–	–
		29	–	–	–	–	38
		30	21	24	29	34	–
		39	–	–	33	38	45
		49	–	–	–	–	50
	soldering star	25	–	6	7	–	–
		30	6	7	8	10	–
		39	–	–	9	11	13
49		–	–	–	–	14	
Useful life 140 °C; V_R ; 0.6 · $I_{AC,R}$ 125 °C; V_R ; $I_{AC,R}$ 85 °C; V_R ; $I_{AC,max}$ 40 °C; V_R ; 2 · $I_{AC,R}$	> 2000 h					Requirements: $\Delta C/C \leq \pm 30\%$ of initial value ESR ≤ 3 times initial specified limit $I_{\text{leak}} \leq$ initial specified limit	
	> 5000 h						
	> 15000 h						
	> 500000 h						
Voltage endurance test 125 °C; V_R	2000 h					Post test requirements: $\Delta C/C \leq \pm 10\%$ of initial value ESR $\leq 1.3\%$ initial specified limit $I_{\text{leak}} \leq$ initial specified limit	
Vibration resistance test	To IEC 60068-2-6, test Fc: Frequency range 10 Hz ... 2 kHz, displacement amplitude max. 1.5 mm, acceleration max. 20 g, duration 3 × 2 h. Capacitor mounted by its wire leads at a distance of (6 ± 1) mm from the case and additionally clamped by the case.						
IEC climatic category	To IEC 60068-1: 55/125/56 (–55 °C/+125 °C/56 days damp heat test)						
Detail specification	Similar to CECC 30301-802						
Sectional specification	IEC 60384-4						

1) If optimum circuit design is used, the values are lower by 30%.



B41690, B41790

Ultra compact – up to 140 °C

B41690, Axial-lead capacitors

Dimensional drawing

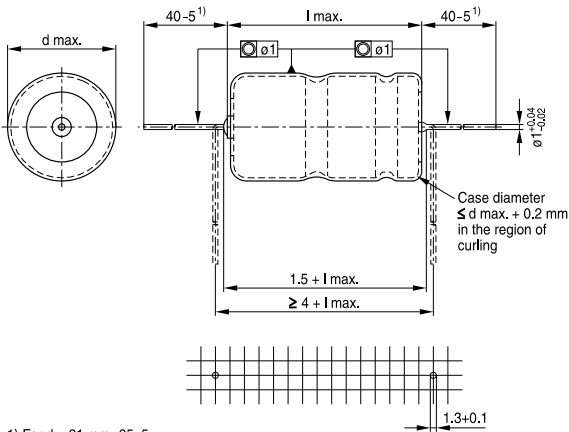

Dimensions, weights and packing units

d × l mm	d _{max} × l _{max} mm	Approx. weight g	Packing units (pcs.)	
			Pallet	Reel
12 × 30	12.5 × 30.5	5.1	288	450
14 × 25	14.5 × 25.5	5.7	200	350
14 × 30	14.5 × 30.5	6.8	200	350
16 × 25	16.5 × 25.5	7.4	180	250
16 × 30	16.5 × 30.5	8.9	180	250
16 × 39	16.5 × 40	11.7	180	—
18 × 30	18.5 × 30.5	11.1	160	—
18 × 39	18.5 × 40	14.7	160	—
20 × 29	20.5 × 29.5	13.5	140	—
21 × 39	21.5 × 40	20.0	140	—
21 × 49	21.5 × 50	25.0	110	—

B41790, Soldering star capacitors
Dimensional drawings

 Mounting holes $d = 12 \text{ mm} \dots 14 \text{ mm}$

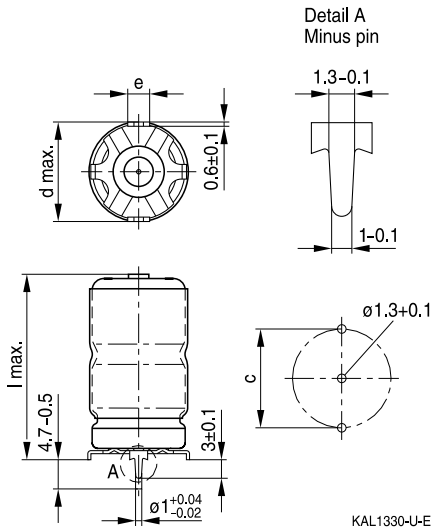
 Mounting holes $d = 16 \text{ mm} \dots 21 \text{ mm}$

Dimensions, weights and packing units

$d \times l$ mm	$d_{\max} \times l_{\max}$ mm	$c \pm 0.1$ mm	$e \pm 0.1$ mm	Approx. weight g	Packing units pcs.
12 × 30	13.5 × 32	12.5	3.0	5.4	480
14 × 25	15.5 × 27	14.5	3.0	6.1	480
14 × 30	15.5 × 32	14.5	3.0	7.2	480
16 × 25	17.5 × 27	16.5	3.0	7.9	300
16 × 30	17.5 × 32	16.5	3.0	9.4	300
16 × 39	17.5 × 41.5	16.5	3.0	12.2	200
18 × 30	19.5 × 32	18.5	3.0	11.8	300
18 × 39	19.5 × 41.5	18.5	3.0	15.4	200
21 × 39	22.5 × 41.5	21.5	3.5	21.0	324
21 × 49	22.5 × 51.5	21.5	3.5	26.0	264



B41690, B41790

Ultra compact – up to 140 °C

Overview of available types

V_R (V DC)	25	35	40	63
	Case dimensions $d \times l$ (mm)			
C_R (μF)				
300				12 × 30
470				14 × 30
600			12 × 30	
680				16 × 30
1000		14 × 25	14 × 30	16 × 39
1200	12 × 30			
1300				18 × 39
1400		16 × 25	16 × 30	
1800			18 × 30	
1900		16 × 30		
2000	14 × 30			21 × 39
2300			20 × 29	
2500		18 × 30		21 × 49
2700			18 × 39	
2900	16 × 30			
3000		20 × 29		
3800		18 × 39		
3900	18 × 30		21 × 39	
4300	16 × 39			
5000	20 × 29			
5200		21 × 39	21 × 49	
5800	18 × 39			
7000		21 × 49		
8000	21 × 39			
10000	21 × 49			

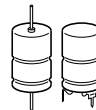
Case dimensions and ordering codes

V_R	C_R	Case dimensions $d \times l$ mm	Ordering code Axial pallet	Ordering code Axial reel	Ordering code Soldering star
25	100 Hz	12×30 14×30 16×30 18×30 18×39 20×29 18×39 21×39 21×49	B41690A5128Q007	B41690A5128Q009	B41790A5128Q000
	20 °C		B41690A5208Q007	B41690A5208Q009	B41790A5208Q000
	μF		B41690A5298Q007	B41690A5298Q009	B41790A5298Q000
			B41690A5398Q007		B41790A5398Q000
			B41690A5438Q007	B41690A5438Q009	B41790A5438Q000
			B41690A5508Q007		
			B41690A5588Q007		B41790A5588Q000
			B41690A5808Q007		B41790A5808Q000
			B41690A5109Q007		B41790A5109Q000
	35		1000	14×25 16×25 16×30 18×30 20×29 18×39 21×39 21×49	B41690A7108Q007
1400		B41690A7148Q007	B41690A7148Q009		B41790A7148Q000
1900		B41690A7198Q007	B41690A7198Q009		B41790A7198Q000
2500		B41690A7258Q007			B41790A7258Q000
3000		B41690A7308Q007			
3800		B41690A7388Q007			B41790A7388Q000
5200		B41690A7528Q007			B41790A7528Q000
7000		B41690A7708Q007			B41790A7708Q000
40		600	12×30 14×30 16×30 18×30 20×29 18×39 21×39 21×49		B41690A7607Q007
	1000	B41690B7108Q007		B41690B7108Q009	B41790B7108Q000
	1400	B41690B7148Q007		B41690B7148Q009	B41790B7148Q000
	1800	B41690A7188Q007			B41790A7188Q000
	2300	B41690A7238Q007			
	2700	B41690A7278Q007			B41790A7278Q000
	3900	B41690A7398Q007			B41790A7398Q000
	5200	B41690B7528Q007			B41790B7528Q000
	63	300		12×30 14×30 16×30 16×39 18×39 21×39 21×49	B41690A8307Q007
470		B41690A8477Q007	B41690A8477Q009		B41790A8477Q000
680		B41690A8687Q007	B41690A8687Q009		B41790A8687Q000
1000		B41690A8108Q007	B41690A8108Q009		B41790A8108Q000
1300		B41690A8138Q007			B41790A8138Q000
2000		B41690A8208Q007			B41790A8208Q000
2500		B41690A8258Q007			B41790A8258Q000

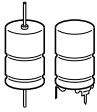

B41690, B41790
Ultra compact – up to 140 °C
Technical data

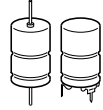
C_R	ESR_{typ}	ESR_{max}	ESR_{max}	ESR_{max}	Z_{max}	$I_{AC,max}$	$I_{AC,max}$	$I_{AC,max}$	$I_{AC,R}$	$I_{AC,max}$
100 Hz	100 Hz	100 Hz	100 Hz	10 kHz	100 kHz	10 kHz	10 kHz	10 kHz	10 kHz	10 kHz
20 °C	20 °C	20 °C	-40 °C	20 °C	20 °C	85 °C	105 °C	125 °C	125 °C	140 °C
μF	$m\Omega$	$m\Omega$	$m\Omega$	$m\Omega$	$m\Omega$	A	A	A	A	A
$V_R = 25 V DC$										
1200	80	135	1000	70	68	5.7	4.9	3.6	2.5	1.6
2000	50	90	620	48	47	6.8	5.8	4.3	3.0	1.9
2900	35	60	460	32	31	9.7	8.4	6.2	4.3	2.8
3900	27	45	330	25	24	11.0	9.4	7.0	4.8	3.1
4300	23	40	310	21	21	13.4	11.6	8.6	5.9	3.5
5000	23	37	260	21	21	11.6	10.0	7.4	5.1	3.3
5800	18	30	230	17	17	15.0	12.9	9.5	6.6	4.3
8000	15	25	160	14	14	16.6	14.2	10.5	7.3	4.8
10000	12	20	130	11	11	20.7	17.7	13.2	9.1	5.9
$V_R = 35 V DC$										
1000	75	125	900	65	63	5.5	4.7	3.5	2.4	1.5
1400	60	100	620	52	50	5.9	5.0	3.7	2.6	1.7
1900	38	65	460	32	31	9.5	8.2	6.1	4.2	2.7
2500	32	50	360	25	24	11.0	9.4	7.0	4.8	3.1
3000	27	45	310	23	22	11.6	10.0	7.4	5.1	3.3
3800	21	35	210	17	17	14.8	12.7	9.4	6.5	4.2
5200	16	27	160	14	14	16.4	14.0	10.4	7.2	4.7
7000	13	21	120	11	11	20.7	17.7	13.2	9.1	5.9
$V_R = 40 V DC$										
600	100	165	1000	70	68	5.7	4.9	3.6	2.5	1.6
1000	65	105	620	48	47	6.8	5.8	4.3	3.0	1.9
1400	45	70	460	32	31	9.6	8.2	6.1	4.2	2.7
1800	35	58	330	26	25	10.9	9.4	6.9	4.8	3.1
2300	30	48	260	23	22	11.6	10.0	7.4	5.1	3.3
2700	25	40	210	17	17	14.8	12.7	9.4	6.5	4.2
3900	18	30	150	14	14	16.4	14.0	10.4	7.2	4.7
5200	14	23	120	11	11	20.7	17.7	13.2	9.1	5.9
$V_R = 63 V DC$										
300	160	260	2500	120	115	5.0	4.3	3.2	2.2	1.4
470	105	175	1600	83	80	6.1	5.3	3.9	2.7	1.7
680	80	130	1100	65	62	7.1	6.0	4.4	3.1	2.0
1000	50	80	750	38	36	11.6	10.0	7.4	5.1	3.3
1300	40	64	580	30	28	13.2	11.4	8.5	5.8	3.4
2000	27	44	370	23	22	15.4	13.2	9.8	6.8	4.4
2500	22	35	300	18	17	19.3	16.5	12.3	8.5	5.5

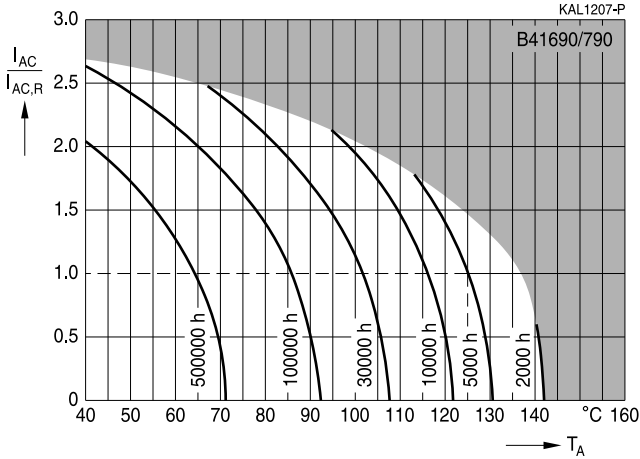

Useful life

depending on ambient temperature T_A under ripple current operating conditions at $V_R^{1)}$



Useful life

depending on case temperature T_C under ripple current operating conditions at $V_R^{1)}$

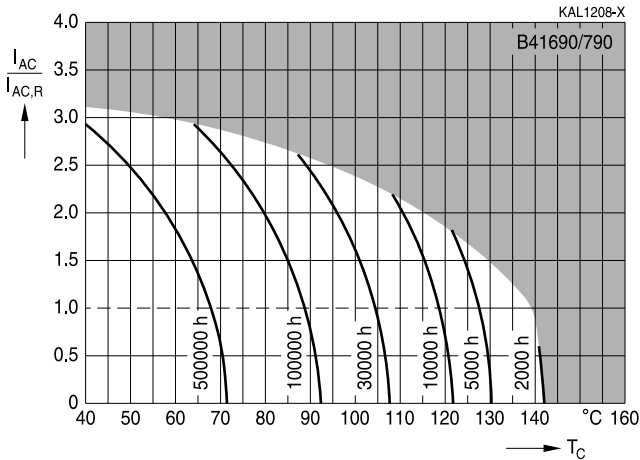

1) Refer to chapter "General technical information, 5.3 Calculation of useful life" for an explanation on how to interpret the useful life graphs.

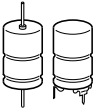

B41690, B41790

Ultra compact – up to 140 °C

Useful life

depending on ambient temperature T_A under ripple current operating conditions at $V_{op}^{2)}$

$V_R = 25\text{ V}; V_{op} \leq 20\text{ V}; V_R = 35\text{ V}; V_{op} \leq 30\text{ V};$

$V_R = 40\text{ V}; V_{op} \leq 35\text{ V}; V_R = 63\text{ V}; V_{op} \leq 55\text{ V}$

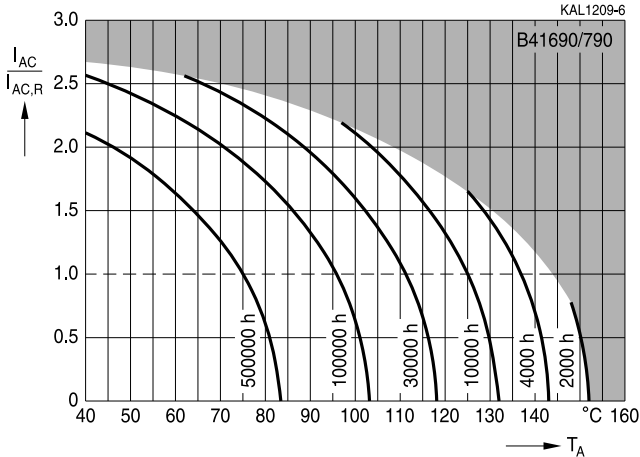

Useful life

depending on case temperature T_C under ripple current operating conditions at $V_{op}^{2)}$

$V_R = 25\text{ V}; V_{op} \leq 20\text{ V}; V_R = 35\text{ V}; V_{op} \leq 30\text{ V};$

$V_R = 40\text{ V}; V_{op} \leq 35\text{ V}; V_R = 63\text{ V}; V_{op} \leq 55\text{ V}$

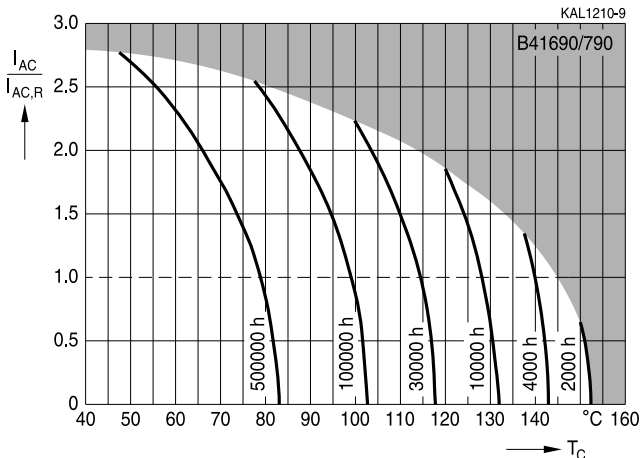

2) Refer to chapter "General technical information, 5.3 Calculation of useful life" for an explanation on how to interpret the useful life graphs.

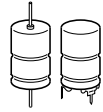
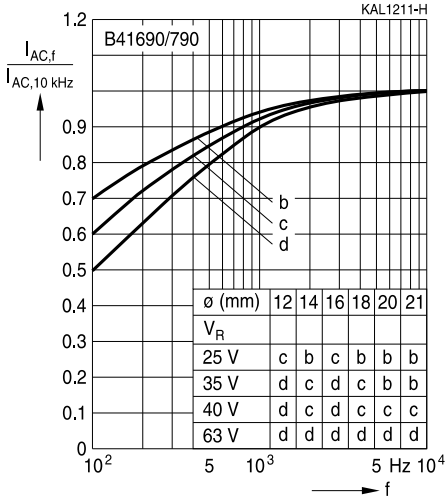
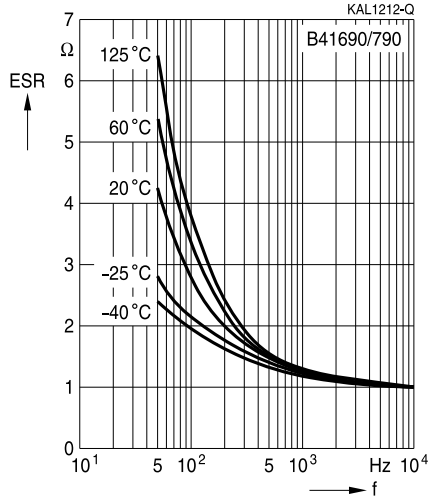
Frequency factor of permissible ripple current I_{AC} versus frequency f

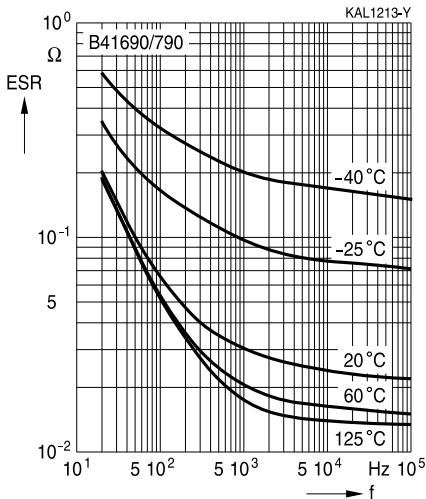
Frequency characteristics of ESR
 Typical behavior

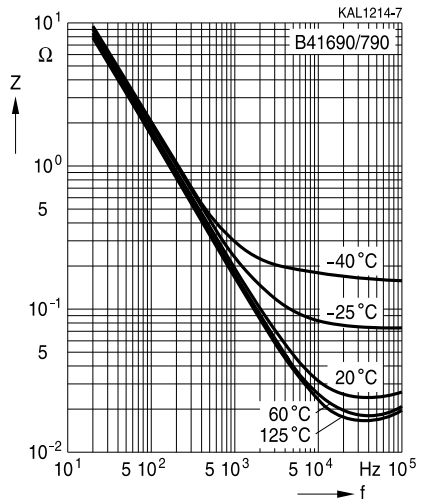
Equivalent series resistance ESR versus frequency f

 Typical behavior for 1000 μ F/40 V

Impedance Z versus frequency f

 Typical behavior for 1000 μ F/40 V

**B41690, B41790****Ultra compact – up to 140 °C**

Cautions and warnings

Personal safety

The electrolytes used by EPCOS have not only been optimized with a view to the intended application, but also with regard to health and environmental compatibility. They do not contain any solvents that are detrimental to health, e.g. dimethyl formamide (DMF) or dimethyl acetamide (DMAC).

Furthermore, part of the high-voltage electrolytes used by EPCOS are self-extinguishing. They contain flame-retarding substances which will quickly extinguish any flame that may have been ignited.

As far as possible, EPCOS does not use any dangerous chemicals or compounds to produce operating electrolytes. However, in exceptional cases, such materials must be used in order to achieve specific physical and electrical properties because no safe substitute materials are currently known. However, the amount of dangerous materials used in our products has been limited to an absolute minimum. Nevertheless, the following rules should be observed when handling aluminum electrolytic capacitors:

- Any escaping electrolyte should not come into contact with eyes or skin.
- If electrolyte does come into contact with the skin, wash the affected parts immediately with running water. If the eyes are affected, rinse them for 10 minutes with plenty of water. If symptoms persist, seek medical treatment.
- Avoid breathing in electrolyte vapor or mists. Workplaces and other affected areas should be well ventilated. Clothing that has been contaminated by electrolyte must be changed and rinsed in water.

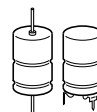

Product safety

The table below summarizes the safety instructions that must be observed without fail. A detailed description can be found in the relevant sections of chapter "General technical information".

Topic	Safety information	Reference chapter "General technical information"
Polarity	Make sure that polar capacitors are connected with the right polarity.	1 "Basic construction of aluminum electrolytic capacitors"
Reverse voltage	Voltages polarity classes should be prevented by connecting a diode.	3.1.6 "Reverse voltage"
Upper category temperature	Do not exceed the upper category temperature.	7.2 "Maximum permissible operating temperature"
Maintenance	Make periodic inspections of the capacitors. Before the inspection, make sure that the power supply is turned off and carefully discharge the electricity of the capacitors. Do not apply any mechanical stress to the capacitor terminals.	10 "Maintenance"
Mounting position of screw-terminal capacitors	Do not mount the capacitor with the terminals (safety vent) upside down.	11.1. "Mounting positions of capacitors with screw terminals"
Mounting of single-ended capacitors	The internal structure of single-ended capacitors might be damaged if excessive force is applied to the lead wires. Avoid any compressive, tensile or flexural stress. Do not move the capacitor after soldering to PC board. Do not pick up the PC board by the soldered capacitor. Do not insert the capacitor on the PC board with a hole space different to the lead space specified.	11.4 "Mounting considerations for single-ended capacitors"
Robustness of terminals	The following maximum tightening torques must not be exceeded when connecting screw terminals: M5: 2 Nm M6: 2.5 Nm	11.3 "Mounting torques"
Soldering	Do not exceed the specified time or temperature limits during soldering.	11.5 "Soldering"



B41690, B41790

Ultra compact – up to 140 °C

Topic	Safety information	Reference chapter "General technical information"
Soldering, cleaning agents	Do not allow halogenated hydrocarbons to come into contact with aluminum electrolytic capacitors.	11.6 "Cleaning agents"
Passive flammability	Avoid external energy, such as fire or electricity.	8.1 "Passive flammability"
Active flammability	Avoid overload of the capacitors.	8.2 "Active flammability"
		Reference chapter "Capacitors with screw terminals"
Breakdown strength of insulating sleeves	Do not damage the insulating sleeve, especially when ring clips are used for mounting.	"Screw terminals – accessories"

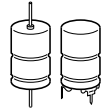
Symbols and terms

Symbol	English	German
C	Capacitance	Kapazität
C_R	Rated capacitance	Nennkapazität
C_S	Series capacitance	Serienkapazität
$C_{S,T}$	Series capacitance at temperature T	Serienkapazität bei Temperatur T
C_f	Capacitance at frequency f	Kapazität bei Frequenz f
d	Case diameter, nominal dimension	Gehäusedurchmesser, Nennmaß
d_{max}	Maximum case diameter	Maximaler Gehäusedurchmesser
ESL	Self-inductance	Eigeninduktivität
ESR	Equivalent series resistance	Ersatzserienwiderstand
ESR_f	Equivalent series resistance at frequency f	Ersatzserienwiderstand bei Frequenz f
ESR_T	Equivalent series resistance at temperature T	Ersatzserienwiderstand bei Temperatur T
f	Frequency	Frequenz
I	Current	Strom
I_{AC}	Alternating current (ripple current)	Wechselstrom
$I_{AC,rms}$	Root-mean-square value of alternating current	Wechselstrom, Effektivwert
$I_{AC,f}$	Ripple current at frequency f	Wechselstrom bei Frequenz f
$I_{AC,max}$	Maximum permissible ripple current	Maximal zulässiger Wechselstrom
$I_{AC,R}$	Rated ripple current	Nennwechselstrom
$I_{AC,R} (B)$	Rated ripple current for base cooling	Nennwechselstromstrom für Bodenkühlung
I_{leak}	Leakage current	Reststrom
$I_{leak,op}$	Operating leakage current	Betriebsreststrom
l	Case length, nominal dimension	Gehäuselänge, Nennmaß
l_{max}	Maximum case length (without terminals and mounting stud)	Maximale Gehäuselänge (ohne Anschlüsse und Gewindebolzen)
R	Resistance	Widerstand
R_{ins}	Insulation resistance	Isolationswiderstand
R_{symm}	Balancing resistance	Symmetrierwiderstand
T	Temperature	Temperatur
ΔT	Temperature difference	Temperaturdifferenz
T_A	Ambient temperature	Umgebungstemperatur
T_C	Case temperature	Gehäusetemperatur
T_B	Capacitor base temperature	Temperatur des Becherbodens
t	Time	Zeit
Δt	Period	Zeitraum
t_b	Service life (operating hours)	Brauchbarkeitsdauer (Betriebszeit)

B41690, B41790
Ultra compact – up to 140 °C

Symbol	English	German
V	Voltage	Spannung
V _F	Forming voltage	Formierspannung
V _{op}	Operating voltage	Betriebsspannung
V _R	Rated voltage, DC voltage	Nennspannung, Gleichspannung
V _S	Surge voltage	Spitzenspannung
X _C	Capacitive reactance	Kapazitiver Blindwiderstand
X _L	Inductive reactance	Induktiver Blindwiderstand
Z	Impedance	Scheinwiderstand
Z _T	Impedance at temperature T	Scheinwiderstand bei Temperatur T
tan δ	Dissipation factor	Verlustfaktor
λ	Failure rate	Ausfallrate
ε ₀	Absolute permittivity	Elektrische Feldkonstante
ε _r	Relative permittivity	Dielektrizitätszahl
ω	Angular velocity; 2 · π · f	Kreisfrequenz; 2 · π · f

Note

All dimensions are given in mm.

Important notes

The following applies to all products named in this publication:

1. Some parts of this publication contain **statements about the suitability of our products for certain areas of application**. These statements are based on our knowledge of typical requirements that are often placed on our products in the areas of application concerned. We nevertheless expressly point out **that such statements cannot be regarded as binding statements about the suitability of our products for a particular customer application**. As a rule, EPCOS is either unfamiliar with individual customer applications or less familiar with them than the customers themselves. For these reasons, it is always ultimately incumbent on the customer to check and decide whether an EPCOS product with the properties described in the product specification is suitable for use in a particular customer application.
2. We also point out that **in individual cases, a malfunction of electronic components or failure before the end of their usual service life cannot be completely ruled out in the current state of the art, even if they are operated as specified**. In customer applications requiring a very high level of operational safety and especially in customer applications in which the malfunction or failure of an electronic component could endanger human life or health (e.g. in accident prevention or lifesaving systems), it must therefore be ensured by means of suitable design of the customer application or other action taken by the customer (e.g. installation of protective circuitry or redundancy) that no injury or damage is sustained by third parties in the event of malfunction or failure of an electronic component.
3. **The warnings, cautions and product-specific notes must be observed.**
4. In order to satisfy certain technical requirements, **some of the products described in this publication may contain substances subject to restrictions in certain jurisdictions (e.g. because they are classed as hazardous)**. Useful information on this will be found in our Material Data Sheets on the Internet (www.epcos.com/material). Should you have any more detailed questions, please contact our sales offices.
5. We constantly strive to improve our products. Consequently, **the products described in this publication may change from time to time**. The same is true of the corresponding product specifications. Please check therefore to what extent product descriptions and specifications contained in this publication are still applicable before or when you place an order. We also **reserve the right to discontinue production and delivery of products**. Consequently, we cannot guarantee that all products named in this publication will always be available. The aforementioned does not apply in the case of individual agreements deviating from the foregoing for customer-specific products.
6. Unless otherwise agreed in individual contracts, **all orders are subject to the current version of the "General Terms of Delivery for Products and Services in the Electrical Industry" published by the German Electrical and Electronics Industry Association (ZVEI)**.
7. The trade names EPCOS, BAOKE, Alu-X, CeraDiode, CSMP, CSSP, CTVS, DeltaCap, DigiSiMic, DSSP, FormFit, MiniBlue, MiniCell, MKK, MKD, MLSC, MotorCap, PCC, PhaseCap, PhaseCube, PhaseMod, PhiCap, SIFERRIT, SIFI, SIKOREL, SilverCap, SIMDAD, SiMic, SIMID, SineFormer, SIOV, SIP5D, SIP5K, ThermoFuse, WindCap are **trade-marks registered or pending** in Europe and in other countries. Further information will be found on the Internet at www.epcos.com/trademarks.