



Aluminum electrolytic capacitors

Axial-lead and soldering star capacitors

Series/Type: B41689, B41789

Date: December 2019

Applications

- Automotive electronics

Features

- High vibration stability, special design with high vibration stability up to 60 g available upon request
- Very high ripple current capability
- Long useful life, 10000 h at up to 125 °C
- Low ESR also at rated voltage 63 V DC
- SIKOREL design – storage for up to 15 years at a temperature of up to 35 °C
- RoHS-compatible

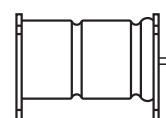
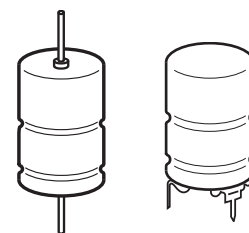

Construction

- Charge/discharge-proof, polar
- Aluminum case with PET insulating sleeve
- Negative pole connected to case
- Version without insulating sleeve available upon request

Terminals

- Axial leads, welded to capacitor case and cover disc
- Soldering star option for upright mounting on PCB or welding to busbar
- Alternative axial-lead design with double-sided plates for horizontal mounting available upon request

Taping and packing

- Axial-lead capacitors will be delivered in pallet package
Capacitors with $d \times l \leq 16 \times 39$ mm are also available taped on reel
- Soldering star capacitors are packed in blister trays

Specifications and characteristics in brief

Rated voltage V_R	25 ... 63 V DC						
Surge voltage V_S	$1.15 \cdot V_R$						
Rated capacitance C_R	360 ... 4500 μF						
Capacitance tolerance	$-10/+30\% \triangleq Q$						
Leakage current I_{leak} (5 min, 20 °C)	$I_{\text{leak}} \leq 0.006 \mu\text{A} \cdot \left(\frac{C_R}{\mu\text{F}} \cdot \frac{V_R}{\text{V}} \right) + 4 \mu\text{A}$						
Self-inductance ESL ¹⁾	Diameter d (mm)		16	18	20	21	
	Terminals		Length l (mm)				
			Approx. ESL (nH)				
	axial	25		26	30	–	–
		29		–	–	38	–
		30		29	34	–	39
		35		31	36	–	41
		39		33	38	–	45
		49		–	–	–	50
	soldering star	25		7	8	–	–
		30		8	10	–	11
		35		9	10.5	–	12
39		9	11	–	13		
49		–	–	–	14		
Useful life ²⁾ 150 °C; V_R ; $0.5 \cdot I_{AC,R}$ 125 °C; V_R ; $I_{AC,max}$ 125 °C; V_R ; $I_{AC,R}$	$> 2000 \text{ h}^3)$		Requirements:				
	$> 4000 \text{ h}$		$ \Delta C/C \leq 30\%$ of initial value				
	$> 10000 \text{ h}$		$I_{\text{leak}} \leq$ initial specified limit				
Voltage endurance test 125 °C; V_R	4000 h for $V_R \leq 40 \text{ V DC}$		Post test requirements:				
	3000 h for $V_R = 63 \text{ V DC}$		$ \Delta C/C \leq 10\%$ of initial value				
			ESR ≤ 1.3 times initial specified limit ⁴⁾				
Vibration resistance test			$I_{\text{leak}} \leq$ initial specified limit				
	To IEC 60068-2-6, test Fc:						
	Frequency range 10 Hz ... 2 kHz, displacement amplitude max. 1.5 mm, acceleration max. 20 g, duration $3 \times 2 \text{ h}$. Capacitor rigidly clamped by the aluminum case e.g. using our standard fixture.						
IEC climatic category	To IEC 60068-1: 55/125/56 (–55 °C/+125 °C/56 days damp heat test)						
Sectional specification	IEC 60384-4						
Reference standard	AEC-Q200 ⁵⁾						

1) If optimum circuit design is used, the values are lower by 30%.

2) Refer to chapter "General technical information, 5 Useful life" on how to interpret useful life.

3) Continuous operation above 130 °C is limited to a maximum of 100 h per load duration, and it must be followed by a no-load cycle or operation under 130 °C for at least the same duration.

4) ESR_{max} at 100 Hz, 20 °C

5) Refer to chapter "General technical information, 2.3 AEC-Q200 standard" for further details.

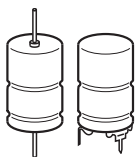

B41689, B41789

Very high ripple current – up to 150 °C

B41689, Axial-lead capacitors

Dimensional drawing

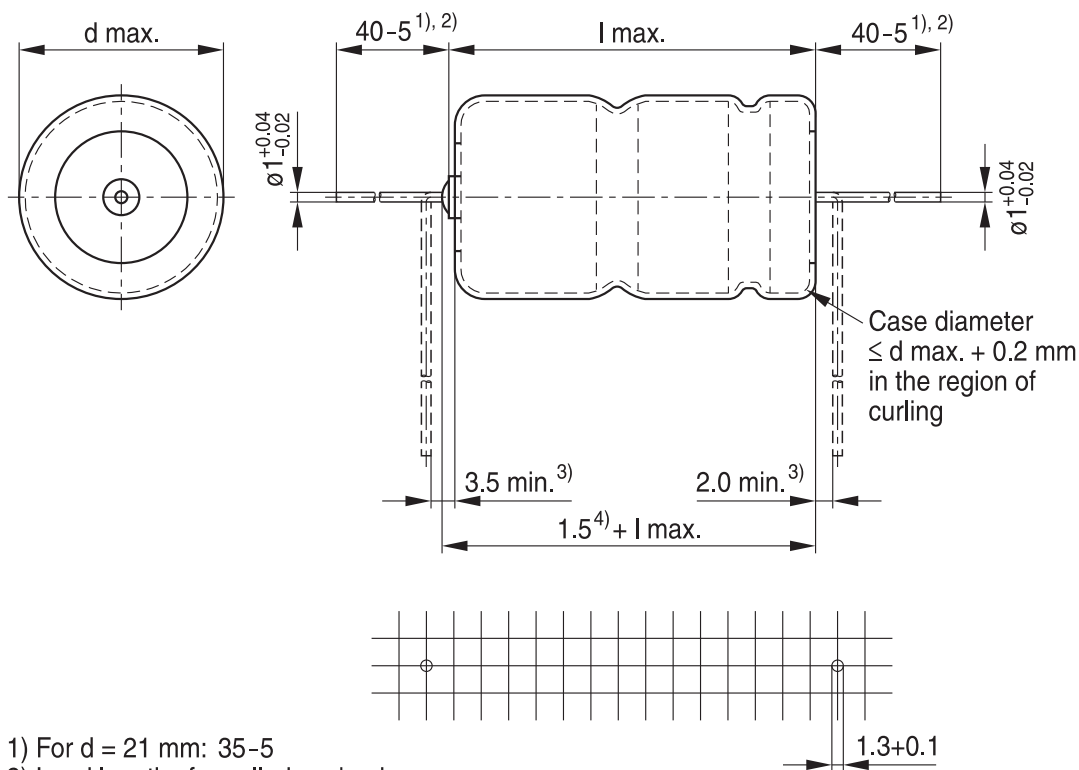

- 1) For d = 21 mm: 35-5
- 2) Lead lengths for palled packaging
- 3) Minimum bending distance recommended per wire
- 4) Maximum length of welding projection

KAL1749-V-E

Dimensions, weights and packing units

d × l mm	d _{max} × l _{max} mm	Approx. weight g	Packing units (pcs.)	
			Pallet	Reel
16 × 25	16.5 × 25.5	7.4	180	250
16 × 30	16.5 × 30.5	8.9	180	250
16 × 35	16.5 × 35.5	10.4	180	250
16 × 39	16.5 × 40	11.7	180	250
18 × 25	18.5 × 25.5	9.3	160	—
18 × 30	18.5 × 30.5	11.1	160	—
18 × 35	18.5 × 35.5	12.8	160	—
18 × 39	18.5 × 40	14.7	160	—
20 × 29	20.5 × 29.5	13.5	140	—
21 × 30	21.5 × 30.5	16.5	140	—
21 × 35	21.5 × 35.5	17.0	140	—
21 × 39	21.5 × 40	20.0	140	—
21 × 49	21.5 × 50	25.0	110	—

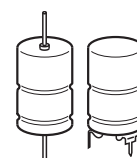
B41789, Soldering star capacitors
Dimensional drawings

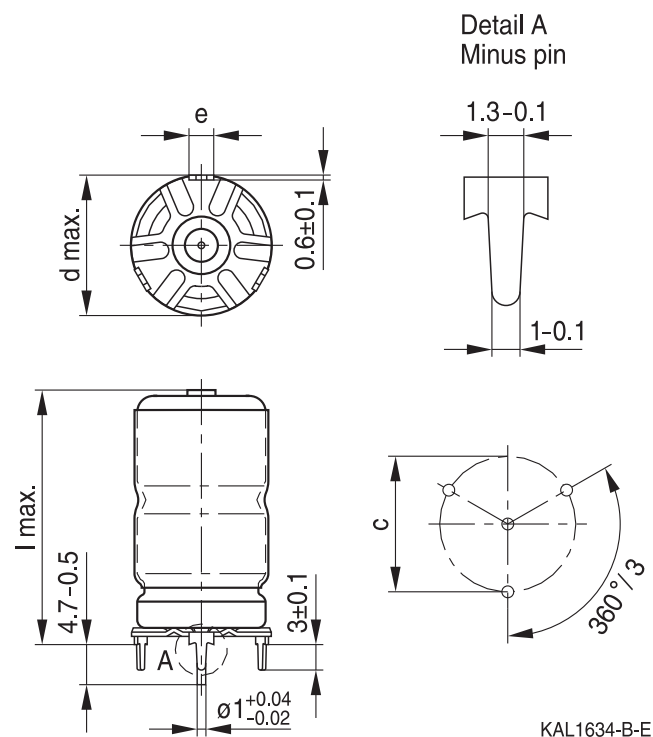
 Mounting holes $d = 16 \text{ mm} \dots 21 \text{ mm}$

Dimensions, weights and packing units

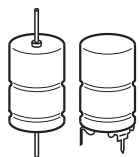
$d \times l$ mm	$d_{\max} \times l_{\max}$ mm	$c \pm 0.1$ mm	$e \pm 0.1$ mm	Approx. weight g	Packing units pcs.
16 × 25	17.5 × 27	16.5	3.0	7.9	300
16 × 30	17.5 × 32	16.5	3.0	9.4	300
16 × 35	17.5 × 37	16.5	3.0	10.9	200
16 × 39	17.5 × 41.5	16.5	3.0	12.2	200
18 × 25	19.5 × 27	18.5	3.0	9.9	300
18 × 30	19.5 × 32	18.5	3.0	11.8	300
18 × 35	19.5 × 37	18.5	3.0	13.2	200
18 × 39	19.5 × 41.5	18.5	3.0	15.4	200
21 × 30	22.5 × 32	21.5	3.5	17.5	468
21 × 35	22.5 × 37	21.5	3.5	18.3	324
21 × 39	22.5 × 41.5	21.5	3.5	21.0	324
21 × 49	22.5 × 51.5	21.5	3.5	26.0	264



B41689, B41789

Very high ripple current – up to 150 °C

Overview of available types

V_R (V DC)	25	40	63
	Case dimensions $d \times l$ (mm)		
C_R (μF)			
360			16 × 25
470			18 × 25
510			16 × 30
560		16 × 25	
620			16 × 35 18 × 30
680		18 × 25	
720		16 × 30	
750			16 × 39
820		16 × 35	18 × 35
900		18 × 30	
910			18 × 39 21 × 30
1000	16 × 25	16 × 39	
1100			21 × 35
1200	18 × 25	20 × 29	
1300	16 × 30		21 × 39
1400		18 × 39	
1500	16 × 35		
1700	18 × 30		
1800	16 × 39		21 × 49
1900	20 × 29		
2000		21 × 39	
2200	18 × 39		
2700		21 × 49	
3300	21 × 39		
4500	21 × 49		

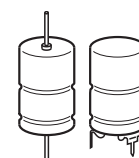
Case dimensions and ordering codes

C_R 120 Hz 20 °C μF	Case dimensions $d \times l$ mm	Ordering code Axial pallet	Ordering code Axial reel	Ordering code Soldering star
$V_R = 25 \text{ V DC}$				
1000	16 × 25	B41689A5108Q001	B41689A5108Q003	B41789A5108Q001
1000 ▽	16 × 25	B41689K5108Q001	B41689K5108Q003	B41789K5108Q001
1200	18 × 25	B41689A5128Q001		B41789A5128Q001
1200 ▽	18 × 25	B41689K5128Q001		B41789K5128Q001
1300	16 × 30	B41689A5138Q001	B41689A5138Q003	B41789A5138Q001
1300 ▽	16 × 30	B41689K5138Q001	B41689K5138Q003	B41789K5138Q001
1500	16 × 35	B41689A5158Q001	B41689A5158Q003	B41789A5158Q001
1500 ▽	16 × 35	B41689K5158Q001	B41689K5158Q003	B41789K5158Q001
1700	18 × 30	B41689A5178Q001		B41789A5178Q001
1700 ▽	18 × 30	B41689K5178Q001		B41789K5178Q001
1800	16 × 39	B41689A5188Q001	B41689A5188Q003	B41789A5188Q001
1800 ▽	16 × 39	B41689K5188Q001	B41689K5188Q003	B41789K5188Q001
1900	20 × 29	B41689A5198Q001		
1900 ▽	20 × 29	B41689K5198Q001		
2200	18 × 39	B41689A5228Q001		B41789A5228Q001
2200 ▽	18 × 39	B41689K5228Q001		B41789K5228Q001
3300	21 × 39	B41689A5338Q001		B41789A5338Q001
3300 ▽	21 × 39	B41689K5338Q001		B41789K5338Q001
4500	21 × 49	B41689A5458Q001		B41789A5458Q001
4500 ▽	21 × 49	B41689K5458Q001		B41789K5458Q001

▽ Increased ripple current due to optimized thermal design

B41689, B41789
Very high ripple current – up to 150 °C
Case dimensions and ordering codes

C_R 120 Hz 20 °C μF	Case dimensions $d \times l$ mm	Ordering code Axial pallet	Ordering code Axial reel	Ordering code Soldering star
$V_R = 40 \text{ V DC}$				
560	16 × 25	B41689A7567Q001	B41689A7567Q003	B41789A7567Q001
560 ▽	16 × 25	B41689K7567Q001	B41689K7567Q003	B41789K7567Q001
680	18 × 25	B41689A7687Q001		B41789A7687Q001
680 ▽	18 × 25	B41689K7687Q001		B41789K7687Q001
720	16 × 30	B41689A7727Q001	B41689A7727Q003	B41789A7727Q001
720 ▽	16 × 30	B41689K7727Q001	B41689K7727Q003	B41789K7727Q001
820	16 × 35	B41689A7827Q001	B41689A7827Q003	B41789A7827Q001
820 ▽	16 × 35	B41689K7827Q001	B41689K7827Q003	B41789K7827Q001
900	18 × 30	B41689A7907Q001		B41789A7907Q001
900 ▽	18 × 30	B41689K7907Q001		B41789K7907Q001
1000	16 × 39	B41689A7108Q001	B41689A7108Q003	B41789A7108Q001
1000 ▽	16 × 39	B41689K7108Q001	B41689K7108Q003	B41789K7108Q001
1200	20 × 29	B41689A7128Q001		
1200 ▽	20 × 29	B41689K7128Q001		
1400	18 × 39	B41689A7148Q001		B41789A7148Q001
1400 ▽	18 × 39	B41689K7148Q001		B41789K7148Q001
2000	21 × 39	B41689A7208Q001		B41789A7208Q001
2000 ▽	21 × 39	B41689K7208Q001		B41789K7208Q001
2700	21 × 49	B41689A7278Q001		B41789A7278Q001
2700 ▽	21 × 49	B41689K7278Q001		B41789K7278Q001

▽ Increased ripple current due to optimized thermal design

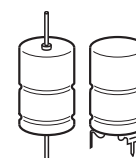
Case dimensions and ordering codes

C_R 120 Hz 20 °C μF	Case dimensions $d \times l$ mm	Ordering code Axial pallet	Ordering code Axial reel	Ordering code Soldering star
$V_R = 63 \text{ V DC}$				
360	16 × 25	B41689B8367Q001	B41689B8367Q003	B41789B8367Q001
360 ▽	16 × 25	B41689L8367Q001	B41689L8367Q003	B41789L8367Q001
470	18 × 25	B41689B8477Q001		B41789B8477Q001
470 ▽	18 × 25	B41689L8477Q001		B41789L8477Q001
510	16 × 30	B41689B8517Q001	B41689B8517Q003	B41789B8517Q001
510 ▽	16 × 30	B41689L8517Q001	B41689L8517Q003	B41789L8517Q001
620	16 × 35	B41689B8627Q001	B41689B8627Q003	B41789B8627Q001
620	18 × 30	B41689C8627Q001		B41789C8627Q001
620 ▽	16 × 35	B41689L8627Q001	B41689L8627Q003	B41789L8627Q001
620 ▽	18 × 30	B41689M8627Q001		B41789M8627Q001
750	16 × 39	B41689B8757Q001	B41689B8757Q003	B41789B8757Q001
750 ▽	16 × 39	B41689L8757Q001	B41689L8757Q003	B41789L8757Q001
820	18 × 35	B41689B8827Q001		B41789B8827Q001
820 ▽	18 × 35	B41689L8827Q001		B41789L8827Q001
910	18 × 39	B41689B8917Q001		B41789B8917Q001
910	21 × 30	B41689C8917Q001		B41789C8917Q001
910 ▽	18 × 39	B41689L8917Q001		B41789L8917Q001
910 ▽	21 × 30	B41689M8917Q001		B41789M8917Q001
1100	21 × 35	B41689B8118Q001		B41789B8118Q001
1100 ▽	21 × 35	B41689L8118Q001		B41789L8118Q001
1300	21 × 39	B41689B8138Q001		B41789B8138Q001
1300 ▽	21 × 39	B41689L8138Q001		B41789L8138Q001
1800	21 × 49	B41689B8188Q001		B41789B8188Q001
1800 ▽	21 × 49	B41689L8188Q001		B41789L8188Q001

▽ Increased ripple current due to optimized thermal design

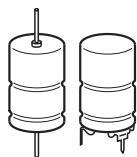
B41689, B41789
Very high ripple current – up to 150 °C
Technical data

C_R	Case dimensions	ESR_{max} 100 Hz	ESR_{max} 100 Hz	ESR_{max} 10 kHz	Z_{max} 100 kHz	$I_{AC,max}^{1)}$ 10 kHz	$I_{AC,max}$ 10 kHz	$I_{AC,R}$ 10 kHz	$I_{AC,max}$ 10 kHz
120 Hz	$d \times l$	20 °C	-40 °C	20 °C	20 °C	T_C 125 °C	125 °C	125 °C	150 °C
20 °C	mm	mΩ	mΩ	mΩ	mΩ	A	A	A	A
μF									
$V_R = 25$ V DC									
1000	16 × 25	98	565	53	50	9.2	5.7	3.5	1.7
1000 ▽	16 × 25	98	565	53	50	10.1	6.0	3.6	1.8
1200	18 × 25	80	470	43	41	11.1	6.9	4.2	2.1
1200 ▽	18 × 25	80	470	43	41	12.2	7.2	4.4	2.2
1300	16 × 30	75	435	41	39	11.4	7.1	4.3	2.2
1300 ▽	16 × 30	75	435	41	39	12.5	7.4	4.5	2.2
1500	16 × 35	65	377	35	34	13.3	8.3	5.0	2.5
1500 ▽	16 × 35	65	377	35	34	14.6	8.6	5.2	2.6
1700	18 × 30	57	332	31	29	14.1	8.8	5.3	2.7
1700 ▽	18 × 30	57	332	31	29	15.5	9.1	5.5	2.8
1800	16 × 39	55	314	30	28	15.1	9.4	5.7	2.9
1800 ▽	16 × 39	55	314	30	28	16.6	9.8	5.9	3.0
1900	20 × 29	52	297	28	27	14.5	9.1	5.5	2.7
1900 ▽	20 × 29	52	297	28	27	16.0	9.5	5.7	2.9
2200	18 × 39	44	257	24	23	18.3	11.4	6.9	3.4
2200 ▽	18 × 39	44	257	24	23	20.1	11.8	7.2	3.6
3300	21 × 39	31	172	17	16	21.0	13.1	7.9	4.0
3300 ▽	21 × 39	31	172	17	16	23.2	13.6	8.3	4.1
4500	21 × 49	23	126	13	12	26.5	16.5	10.0	5.0
4500 ▽	21 × 49	23	126	13	12	29.2	17.2	10.4	5.2

▽ Increased ripple current due to optimized thermal design

 1) Maximum ripple current at 125 °C capacitor case temperature T_C (measured at aluminum case surface), when mounted to a heat sink. Further details available upon request.

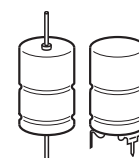
Technical data

C_R	Case dimensions	ESR_{max} 100 Hz	ESR_{max} 100 Hz	ESR_{max} 10 kHz	Z_{max} 100 kHz	$I_{AC,max}^{2)}$ 10 kHz	$I_{AC,max}$ 10 kHz	$I_{AC,R}$ 10 kHz	$I_{AC,max}$ 10 kHz
120 Hz	$d \times l$	20 °C	-40 °C	20 °C	20 °C	T_C 125 °C	125 °C	125 °C	150 °C
20 °C	mm	mΩ	mΩ	mΩ	mΩ	A	A	A	A
μF									
$V_R = 40$ V DC									
560	16 × 25	129	587	53	50	9.2	5.7	3.5	1.7
560 ▽	16 × 25	129	587	53	50	10.1	6.0	3.6	1.8
680	18 × 25	105	483	43	41	11.1	6.9	4.2	2.1
680 ▽	18 × 25	105	483	43	41	12.3	7.2	4.4	2.2
720	16 × 30	100	457	42	39	11.4	7.1	4.3	2.1
720 ▽	16 × 30	100	457	42	39	12.5	7.4	4.5	2.2
820	16 × 35	88	401	36	34	13.2	8.2	5.0	2.5
820 ▽	16 × 35	88	401	36	34	14.5	8.6	5.2	2.6
900	18 × 30	80	365	33	31	13.9	8.6	5.2	2.6
900 ▽	18 × 30	80	365	33	31	15.2	9.0	5.4	2.7
1000	16 × 39	73	329	30	29	15.1	9.4	5.7	2.8
1000 ▽	16 × 39	73	329	30	29	16.6	9.8	5.9	3.0
1200	20 × 29	61	274	26	24	14.9	9.3	5.6	2.8
1200 ▽	20 × 29	61	274	26	24	16.5	9.7	5.9	2.9
1400	18 × 39	52	235	22	20	18.9	11.8	7.1	3.6
1400 ▽	18 × 39	52	235	22	20	20.8	12.2	7.4	3.7
2000	21 × 39	38	165	16	16	21.3	13.2	8.0	4.0
2000 ▽	21 × 39	38	165	16	16	23.4	13.8	8.4	4.2
2700	21 × 49	28	123	12	12	26.8	16.7	10.1	5.0
2700 ▽	21 × 49	28	123	12	12	29.5	17.4	10.5	5.3

▽ Increased ripple current due to optimized thermal design

2) Maximum ripple current at 125 °C capacitor case temperature T_C (measured at aluminum case surface), when mounted to a heat sink. Further details available upon request.

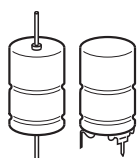
B41689, B41789
Very high ripple current – up to 150 °C
Technical data

C_R	Case dimensions	ESR_{max} 100 Hz	ESR_{max} 100 Hz	ESR_{max} 10 kHz	Z_{max} 100 kHz	$I_{AC,max}^{3)}$ 10 kHz	$I_{AC,max}$ 10 kHz	$I_{AC,R}$ 10 kHz	$I_{AC,max}$ 10 kHz
120 Hz	$d \times l$	20 °C	-40 °C	20 °C	20 °C	T_C 125 °C	125 °C	125 °C	150 °C
20 °C	mm	mΩ	mΩ	mΩ	mΩ	A	A	A	A
μF									
$V_R = 63$ V DC									
360	16 × 25	173	652	58	55	8.9	5.1	3.2	1.6
360 ▽	16 × 25	173	652	58	55	9.2	5.3	3.3	1.6
470	18 × 25	132	499	43	41	11.1	6.3	4.0	2.0
470 ▽	18 × 25	132	499	43	41	11.4	6.6	4.1	2.1
510	16 × 30	124	461	42	40	11.2	6.4	4.0	2.0
510 ▽	16 × 30	124	461	42	40	11.6	6.7	4.2	2.1
620	16 × 35	102	379	34	33	13.4	7.6	4.8	2.4
620	18 × 30	100	379	33	32	13.8	7.9	4.9	2.5
620 ▽	16 × 35	102	379	34	33	13.8	7.9	5.0	2.5
620 ▽	18 × 30	100	379	33	32	14.2	8.2	5.1	2.6
750	16 × 39	84	314	29	27	15.2	8.7	5.5	2.7
750 ▽	16 × 39	84	314	29	27	15.8	9.0	5.6	2.8
820	18 × 35	76	287	26	24	16.6	9.5	6.0	3.0
820 ▽	18 × 35	76	287	26	24	17.2	9.9	6.2	3.1
910	18 × 39	69	258	23	22	18.6	10.6	6.7	3.3
910	21 × 30	71	259	25	24	16.1	9.2	5.8	2.9
910 ▽	18 × 39	69	258	23	22	19.2	11.0	6.9	3.4
910 ▽	21 × 30	71	259	25	24	16.6	9.5	6.0	3.0
1100	21 × 35	58	215	21	20	19.0	10.8	6.8	3.4
1100 ▽	21 × 35	58	215	21	20	19.7	11.2	7.0	3.5
1300	21 × 39	50	182	18	17	21.5	12.3	7.7	3.9
1300 ▽	21 × 39	50	182	18	17	22.3	12.7	8.0	4.0
1800	21 × 49	36	132	13	13	27.3	15.6	9.8	4.9
1800 ▽	21 × 49	36	132	13	13	28.2	16.0	10.0	5.0

▽ Increased ripple current due to optimized thermal design

 3) Maximum ripple current at 125 °C capacitor case temperature T_C (measured at aluminum case surface), when mounted to a heat sink. Further details available upon request.

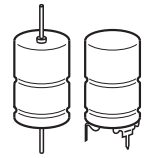

Useful life¹⁾

depending on ambient temperature T_A under ripple current operating conditions at V_R

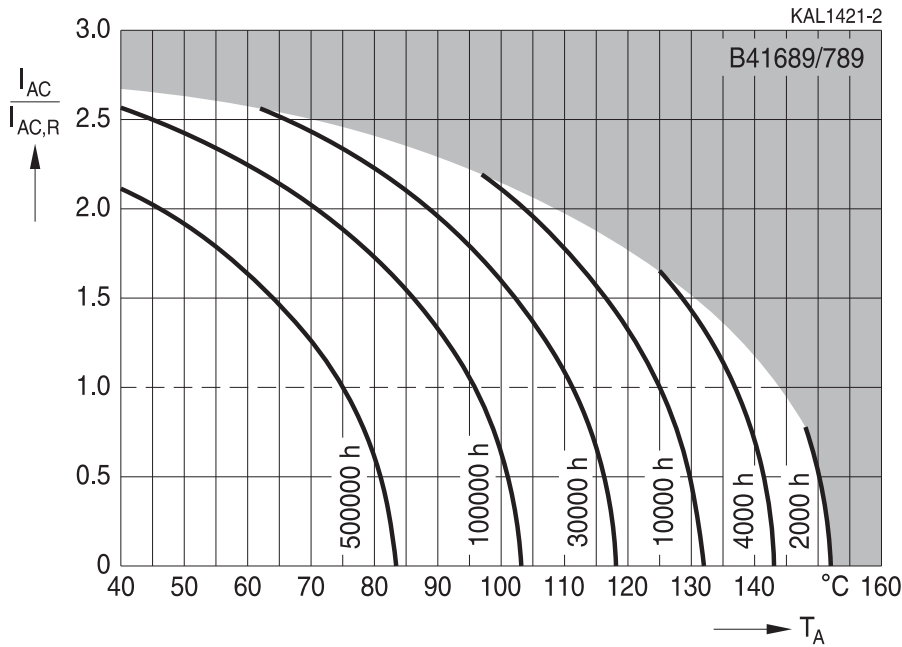

Frequency factor of permissible ripple current I_{AC} versus frequency f

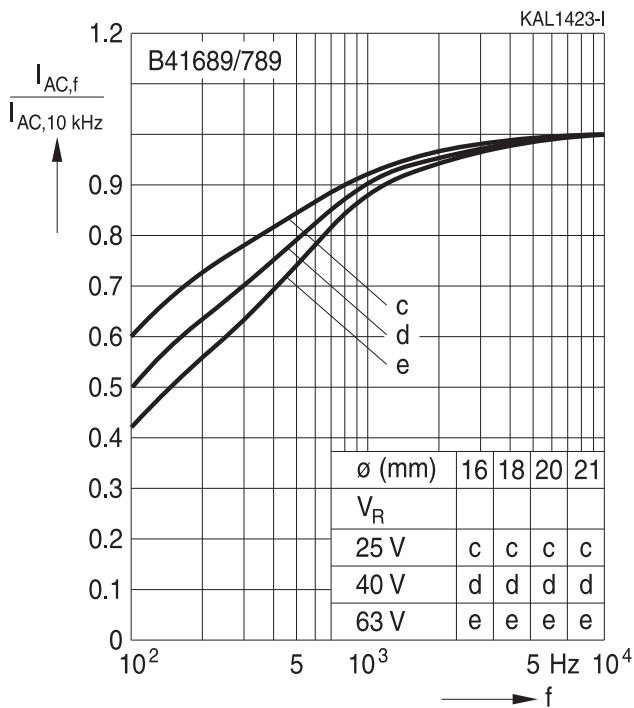

Frequency characteristics of ESR
Typical behavior

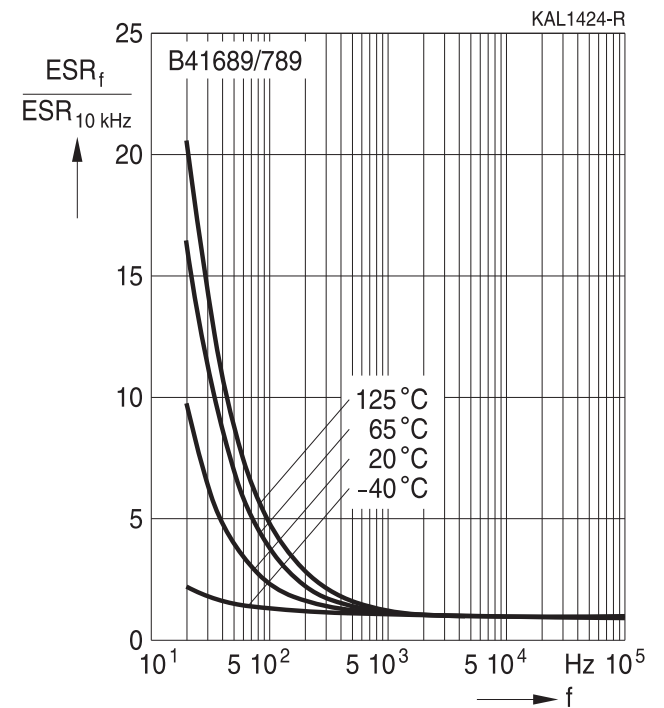

1) Refer to chapter "General technical information, 5 Useful life" on how to interpret useful life.

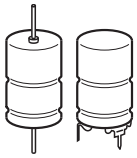

B41689, B41789

Very high ripple current – up to 150 °C

**Equivalent series resistance ESR
versus frequency f**

Typical behavior for 820 μ F/63 V

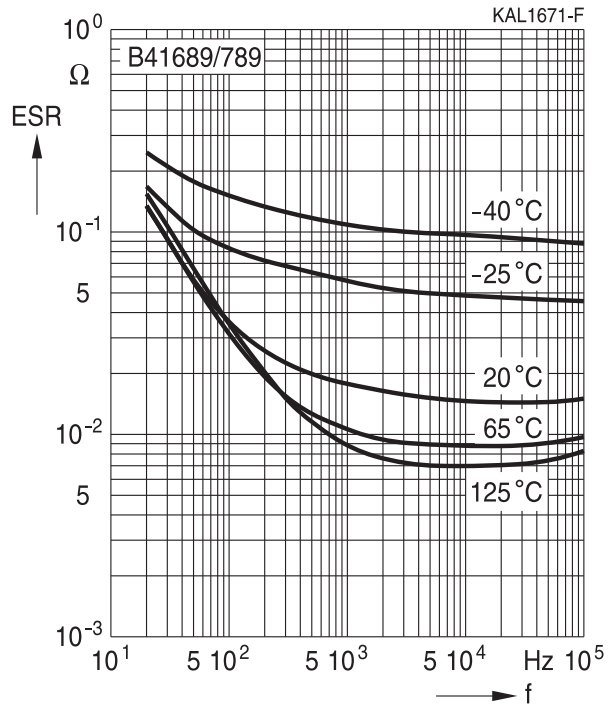

**Impedance Z
versus frequency f**

Typical behavior for 820 μ F/63 V

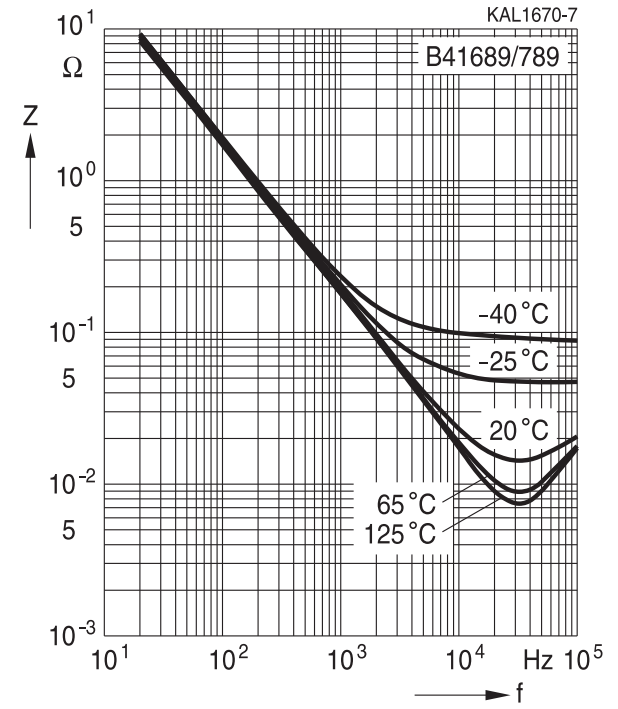



Cautions and warnings

Personal safety

The electrolytes used have been optimized both with a view to the intended application and with regard to health and environmental compatibility. They do not contain any solvents that are detrimental to health, e.g. dimethyl formamide (DMF) or dimethyl acetamide (DMAC). Furthermore, some of the high-voltage electrolytes used are self-extinguishing.

As far as possible, we do not use any dangerous chemicals or compounds to produce operating electrolytes, although in exceptional cases, such materials must be used in order to achieve specific physical and electrical properties because no alternative materials are currently known. We do, however, restrict the amount of dangerous materials used in our products to an absolute minimum.

Materials and chemicals used in our aluminum electrolytic capacitors are continuously adapted in compliance with the TDK Electronics Corporate Environmental Policy and the latest EU regulations and guidelines such as RoHS, REACH/SVHC, GADSL, and ELV.

MDS (Material Data Sheets) are available on our website for all types listed in the data book. MDS for customer specific capacitors are available upon request.

MSDS (Material Safety Data Sheets) are available for our electrolytes upon request.

Nevertheless, the following rules should be observed when handling aluminum electrolytic capacitors: No electrolyte should come into contact with eyes or skin. If electrolyte does come into contact with the skin, wash the affected areas immediately with running water. If the eyes are affected, rinse them for 10 minutes with plenty of water. If symptoms persist, seek medical treatment. Avoid inhaling electrolyte vapor or mists. Workplaces and other affected areas should be well ventilated. Clothing that has been contaminated by electrolyte must be changed and rinsed in water.



B41689, B41789

Very high ripple current – up to 150 °C

Product safety

The table below summarizes the safety instructions that must be observed without fail. A detailed description can be found in the relevant sections of separate file chapter "General technical information".

Topic	Safety information	Reference chapter "General technical information"
Polarity	Make sure that polar capacitors are connected with the right polarity.	1 "Basic construction of aluminum electrolytic capacitors"
Reverse voltage	Voltages of opposite polarity should be prevented by connecting a diode.	3.1.6 "Reverse voltage"
Mounting position of screw-terminal capacitors	Screw terminal capacitors must not be mounted with terminals facing down unless otherwise specified.	11.1. "Mounting positions of capacitors with screw terminals"
Robustness of terminals	The following maximum tightening torques must not be exceeded when connecting screw terminals: M5: 2.5 Nm M6: 4.0 Nm	11.3 "Mounting torques"
Mounting of single-ended capacitors	The internal structure of single-ended capacitors might be damaged if excessive force is applied to the lead wires. Avoid any compressive, tensile or flexural stress. Do not move the capacitor after soldering to PC board. Do not pick up the PC board by the soldered capacitor. Do not insert the capacitor on the PC board with a hole space different to the lead space specified.	11.4 "Mounting considerations for single-ended capacitors"
Soldering	Do not exceed the specified time or temperature limits during soldering.	11.5 "Soldering"
Soldering, cleaning agents	Do not allow halogenated hydrocarbons to come into contact with aluminum electrolytic capacitors.	11.6 "Cleaning agents"
Upper category temperature	Do not exceed the upper category temperature.	7.2 "Maximum permissible operating temperature"
Passive flammability	Avoid external energy, e.g. fire.	8.1 "Passive flammability"

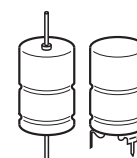

Topic	Safety information	Reference chapter "General technical information"
Active flammability	Avoid overload of the capacitors.	8.2 "Active flammability"
Maintenance	Make periodic inspections of the capacitors. Before the inspection, make sure that the power supply is turned off and carefully discharge the capacitors. Do not apply excessive mechanical stress to the capacitor terminals when mounting.	10 "Maintenance"
Storage	Do not store capacitors at high temperatures or high humidity. Capacitors should be stored at +5 to +35 °C and a relative humidity of ≤ 75%.	7.3 "Shelf life and storage conditions"
		Reference chapter "Capacitors with screw terminals"
Breakdown strength of insulating sleeves	Do not damage the insulating sleeve, especially when ring clips are used for mounting.	"Screw terminals – accessories"

Display of ordering codes for TDK Electronics products

The ordering code for one and the same product can be represented differently in data sheets, data books, other publications, on the company website, or in order-related documents such as shipping notes, order confirmations and product labels. The varying representations of the ordering codes are due to different processes employed and do not affect the specifications of the respective products.

Detailed information can be found on the Internet under www.tdk-electronics.tdk.com/orderingcodes.

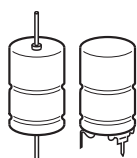

B41689, B41789

Very high ripple current – up to 150 °C

Symbols and terms

Symbol	English	German
C	Capacitance	Kapazität
C_R	Rated capacitance	Nennkapazität
C_S	Series capacitance	Serienkapazität
$C_{S,T}$	Series capacitance at temperature T	Serienkapazität bei Temperatur T
C_f	Capacitance at frequency f	Kapazität bei Frequenz f
d	Case diameter, nominal dimension	Gehäusedurchmesser, Nennmaß
d_{max}	Maximum case diameter	Maximaler Gehäusedurchmesser
ESL	Self-inductance	Eigeninduktivität
ESR	Equivalent series resistance	Ersatzserienwiderstand
ESR_f	Equivalent series resistance at frequency f	Ersatzserienwiderstand bei Frequenz f
ESR_T	Equivalent series resistance at temperature T	Ersatzserienwiderstand bei Temperatur T
f	Frequency	Frequenz
I	Current	Strom
I_{AC}	Alternating current (ripple current)	Wechselstrom
$I_{AC,RMS}$	Root-mean-square value of alternating current	Wechselstrom, Effektivwert
$I_{AC,f}$	Ripple current at frequency f	Wechselstrom bei Frequenz f
$I_{AC,max}$	Maximum permissible ripple current	Maximal zulässiger Wechselstrom
$I_{AC,R}$	Rated ripple current	Nennwechselstrom
I_{leak}	Leakage current	Reststrom
$I_{leak,op}$	Operating leakage current	Betriebsreststrom
l	Case length, nominal dimension	Gehäuselänge, Nennmaß
l_{max}	Maximum case length (without terminals and mounting stud)	Maximale Gehäuselänge (ohne Anschlüsse und Gewindebolzen)
R	Resistance	Widerstand
R_{ins}	Insulation resistance	Isolationswiderstand
R_{symm}	Balancing resistance	Symmetrierwiderstand
T	Temperature	Temperatur
ΔT	Temperature difference	Temperaturdifferenz
T_A	Ambient temperature	Umgebungstemperatur
T_C	Case temperature	Gehäusetemperatur
T_B	Capacitor base temperature	Temperatur des Gehäusebodens
t	Time	Zeit
Δt	Period	Zeitraum
t_b	Service life (operating hours)	Brauchbarkeitsdauer (Betriebszeit)

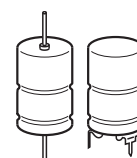

Symbol	English	German
V	Voltage	Spannung
V_F	Forming voltage	Formierspannung
V_{op}	Operating voltage	Betriebsspannung
V_R	Rated voltage, DC voltage	Nennspannung, Gleichspannung
V_S	Surge voltage	Spitzenspannung
X_C	Capacitive reactance	Kapazitiver Blindwiderstand
X_L	Inductive reactance	Induktiver Blindwiderstand
Z	Impedance	Scheinwiderstand
Z_T	Impedance at temperature T	Scheinwiderstand bei Temperatur T
$\tan \delta$	Dissipation factor	Verlustfaktor
λ	Failure rate	Ausfallrate
ϵ_0	Absolute permittivity	Elektrische Feldkonstante
ϵ_r	Relative permittivity	Dielektrizitätszahl
ω	Angular velocity; $2 \cdot \pi \cdot f$	Kreisfrequenz; $2 \cdot \pi \cdot f$

Note

All dimensions are given in mm.

Important notes

The following applies to all products named in this publication:

1. Some parts of this publication contain **statements about the suitability of our products for certain areas of application**. These statements are based on our knowledge of typical requirements that are often placed on our products in the areas of application concerned. We nevertheless expressly point out **that such statements cannot be regarded as binding statements about the suitability of our products for a particular customer application**. As a rule, we are either unfamiliar with individual customer applications or less familiar with them than the customers themselves. For these reasons, it is always ultimately incumbent on the customer to check and decide whether a product with the properties described in the product specification is suitable for use in a particular customer application.
2. We also point out that **in individual cases, a malfunction of electronic components or failure before the end of their usual service life cannot be completely ruled out in the current state of the art, even if they are operated as specified**. In customer applications requiring a very high level of operational safety and especially in customer applications in which the malfunction or failure of an electronic component could endanger human life or health (e.g. in accident prevention or lifesaving systems), it must therefore be ensured by means of suitable design of the customer application or other action taken by the customer (e.g. installation of protective circuitry or redundancy) that no injury or damage is sustained by third parties in the event of malfunction or failure of an electronic component.
3. **The warnings, cautions and product-specific notes must be observed.**
4. In order to satisfy certain technical requirements, **some of the products described in this publication may contain substances subject to restrictions in certain jurisdictions (e.g. because they are classed as hazardous)**. Useful information on this will be found in our Material Data Sheets on the Internet (www.tdk-electronics.tdk.com/material). Should you have any more detailed questions, please contact our sales offices.
5. We constantly strive to improve our products. Consequently, **the products described in this publication may change from time to time**. The same is true of the corresponding product specifications. Please check therefore to what extent product descriptions and specifications contained in this publication are still applicable before or when you place an order. We also **reserve the right to discontinue production and delivery of products**. Consequently, we cannot guarantee that all products named in this publication will always be available. The aforementioned does not apply in the case of individual agreements deviating from the foregoing for customer-specific products.
6. Unless otherwise agreed in individual contracts, **all orders are subject to our General Terms and Conditions of Supply**.

Important notes

7. **Our manufacturing sites serving the automotive business apply the IATF 16949 standard.** The IATF certifications confirm our compliance with requirements regarding the quality management system in the automotive industry. Referring to customer requirements and customer specific requirements (“CSR”) TDK always has and will continue to have the policy of respecting individual agreements. Even if IATF 16949 may appear to support the acceptance of unilateral requirements, we hereby like to emphasize that **only requirements mutually agreed upon can and will be implemented in our Quality Management System.** For clarification purposes we like to point out that obligations from IATF 16949 shall only become legally binding if individually agreed upon.
8. The trade names EPCOS, CeraCharge, CeraDiode, CeraLink, CeraPad, CeraPlas, CSMP, CTVS, DeltaCap, DigiSiMic, ExoCore, FilterCap, FormFit, LeaXield, MiniBlue, MiniCell, MKD, MKK, MotorCap, PCC, PhaseCap, PhaseCube, PhaseMod, PhiCap, PowerHap, PQSine, PQvar, SIFERRIT, SIFI, SIKOREL, SilverCap, SIMDAD, SiMic, SIMID, SineFormer, SIOV, ThermoFuse, WindCap are **trademarks registered or pending** in Europe and in other countries. Further information will be found on the Internet at www.tdk-electronics.tdk.com/trademarks.

Release 2018-10