

SIKOREL® 125, LL grade

Extremely high reliability and long useful life

Construction

- Charge-discharge proof, polar
- Aluminum case, partially insulated
- Solder pin terminals on mounting base that is securely welded to case, ensuring perfect electrical contact
- Positive pole connection brought out axially at center
- Negative pole connected to two or three solder pins of the mounting base

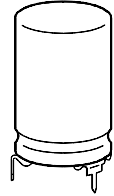

KAL0276-R

Features

- Extremely high reliability and long useful life
- Very wide temperature range
- Outstanding parametric stability
- High ripple current capability
- Can be operated at temperatures of up to 145 °C 1)
- Shelf life up to 10 years
- Pinning ensures correct insertion

Applications

- High-reliability equipment in industrial and automotive electronics

Specifications and characteristics in brief

Rated voltage U_R	10 to 100 V-	
Surge voltage U_S	$1,15 \cdot U_R$	
Rated capacitance C_R	47 to 4 700 μ F	
Capacitance tolerance	- 10/+ 50 % \triangleq T	
Useful life	$d \leq 18$ mm	$d = 21$ mm, 25 mm
	40 °C, U_R	> 200 000 h ($3,5 \cdot I_{-R,125^\circ\text{C}}$)
	85 °C, U_R ; I_{-max}	> 15 000 h
125 °C, U_R ; I_{-R}	> 3 000 h	> 10 000 h
Failure percentage	$\leq 0,5$ % (during useful life)	
Failure rate	≤ 10 fit ($\leq 10 \cdot 10^{-9}/\text{h}$)	
Voltage endurance test	2 000 h, 125 °C (at U_R)	

1) Operation at 145 °C and 0,6 V_R permissible for a total of 500 h.

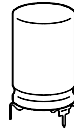

Specifications and characteristics in brief

Leakage current I_{lka} (5 min, 20 °C)	$I_{lka} \leq 0,3 \mu A \cdot \left(\frac{C_R}{\mu F} \cdot \frac{U_R}{V} \right)^{0,7} + 4 \mu A$						
Self-inductance L_{ESL}	d (mm)	12	14	16	18	21	25
	l (mm)	30	30	30	39,5	40	40
	L_{ESL} approx. (nH)	23	37	37	37	17	17
IEC climatic category	in accordance with IEC 68-1 55/125/56 (– 55 °C/+ 125 °C, 56 days damp heat test)						
Detail specification	similar to CECC 30 301-802						
Sectional specification	IEC 384-4						
Vibration resistance	in accordance with IEC 68–2–6, test Fc: displacement amplitude 0,75 mm, frequency range 10 ... 55 Hz, acceleration max. 10 g, duration 3 × 2 h						

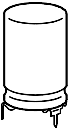

B 41 592

Dimensional drawing

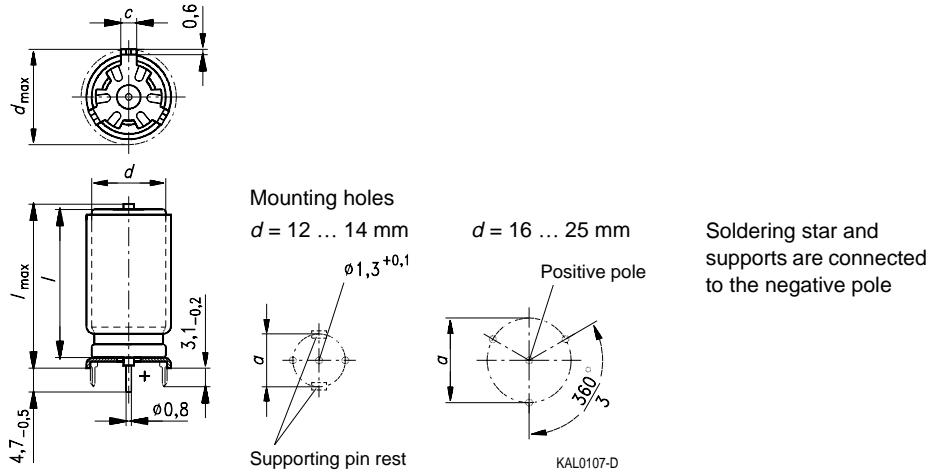

Dimensions (mm)				Approx weight (g)	Packing units (pieces)
$d \times l$	$d_{\max} \times l_{\max}$	$a \pm 0,1$	$c \pm 0,1$		
12 × 30	13,5 × 33	12,5	3,0	5,7	480
14 × 30	15,5 × 33	14,5		7,9	480
16 × 30	17,5 × 33	16,5		9,8	300
18 × 39,5	19,5 × 40,8	18,5		15	200
21 × 40	22,5 × 42	21,5	3,5	19	128
25 × 40	26,5 × 42	25,5		27	128

The PC-board hole arrangement specified above is based on circular arcs.

If, however, the mounting holes have to be matched to a standard drilling raster, a spacing of 1,27 mm ($1/20''$) has proved to be sufficiently accurate if the following arrangements are used:

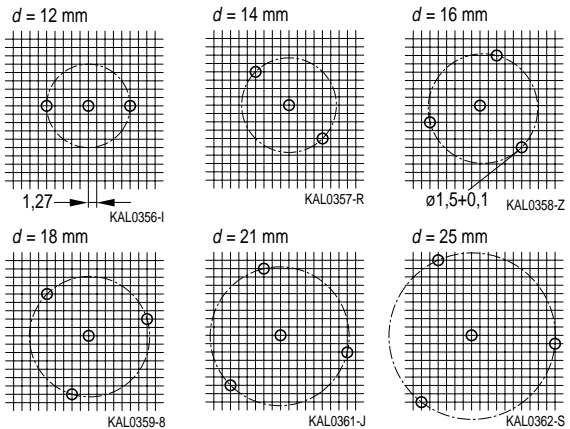

Not for new design

For new design see type B 41 784, [page 330](#)

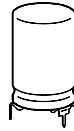

Overview of available types

U_R (V-)	10	16	25	40	63	100
C_R (μ F)	Case dimensions $d \times l$ (mm)					
47						12 × 30
100					12 × 30	16 × 30
220			12 × 30	12 × 30	16 × 30	18 × 39,5
470	12 × 30	12 × 30	14 × 30	16 × 30	18 × 39,5	25 × 40
1 000	14 × 30	16 × 30	18 × 39,5	21 × 40	25 × 40	
2 200	18 × 39,5	18 × 39,5	21 × 40	25 × 40		
4 700	25 × 40	25 × 40				

The capacitance and voltage ratings listed above are available in different cases upon request. Other voltage and capacitance ratings are also available upon request.

Not for new design. For new design see type B 41 784, [page 330](#)

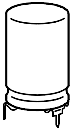

B 41 592

Technical data and ordering codes

U_R	C_R	Case dimensions $d \times l$ mm	$R_{ESR, typ}$ 100 Hz 20 °C Ω	$R_{ESR, max}$ 100 Hz 20 °C Ω	Z_{max} 10 kHz 20 °C Ω	$I_{~max}$ 100 Hz 40 °C A	$I_{~max}$ 100 Hz 85 °C A	$I_{~R}$ 100 Hz 125 °C A	Ordering code ¹⁾ Short code
B41 592-									
10	470	12 × 30	0,29	0,56	0,22	1,8	1,3	0,45	-A3477-T
	1 000	14 × 30	0,14	0,26	0,14	2,8	1,9	0,69	-A3108-T
	2 200	18 × 39,5	0,06	0,12	0,10	5,6	3,9	1,4	-A3228-T
	4 700	25 × 40	0,04	0,07	0,07	8,0	5,6	2,0	-A3478-T
16	470	12 × 30	0,25	0,48	0,22	2,0	1,4	0,49	-A4477-T
	1 000	16 × 30	0,12	0,23	0,12	3,2	2,2	0,80	-A4108-T
	2 200	18 × 39,5	0,06	0,10	0,10	5,6	3,9	1,4	-A4228-T
	4 700	25 × 40	0,04	0,06	0,06	8,0	5,6	2,0	-A4478-T
25	220	12 × 30	0,41	0,79	0,38	1,5	1,1	0,38	-A5227-T
	470	14 × 30	0,20	0,37	0,20	2,3	1,6	0,58	-A5477-T
	1 000	18 × 39,5	0,10	0,18	0,12	4,0	2,8	1,0	-A5108-T
	2 200	21 × 40	0,05	0,10	0,10	6,4	4,5	1,6	-A5228-T
40	220	12 × 30	0,34	0,64	0,36	1,7	1,2	0,42	-A7227-T
	470	16 × 30	0,16	0,30	0,20	2,8	1,9	0,69	-A7477-T
	1 000	21 × 40	0,08	0,16	0,12	5,2	3,6	1,3	-A7108-T
	2 200	25 × 40	0,04	0,08	0,08	8,0	5,6	2,0	-A7228-T
63	100	12 × 30	0,63	1,2	0,66	1,2	0,87	0,31	-A8107-T
	220	16 × 30	0,31	0,56	0,34	2,0	1,4	0,50	-A8227-T
	470	18 × 39,5	0,14	0,26	0,18	3,5	2,5	0,88	-A8477-T
	1 000	25 × 40	0,08	0,14	0,12	5,6	3,9	1,4	-A8108-T
100	47	12 × 30	1,8	3,4	1,9	0,72	0,50	0,18	-A9476-T
	100	16 × 30	0,79	1,5	0,90	1,2	0,87	0,31	-A9107-T
	220	18 × 39,5	0,38	0,72	0,50	2,2	1,5	0,54	-A9227-T
	470	25 × 40	0,20	0,38	0,30	3,5	2,5	0,88	-A9477-T

Not for new design. For new design see type B 41 784, [page 330](#)

1) To obtain the required ordering code, prefix the type number to the short code. E. g.: B41592-A3477-T

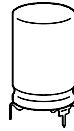

Useful life

versus ambient temperature T_A under ripple current operating conditions ¹⁾

$d \geq 12 \text{ mm} \dots 18 \text{ mm}$

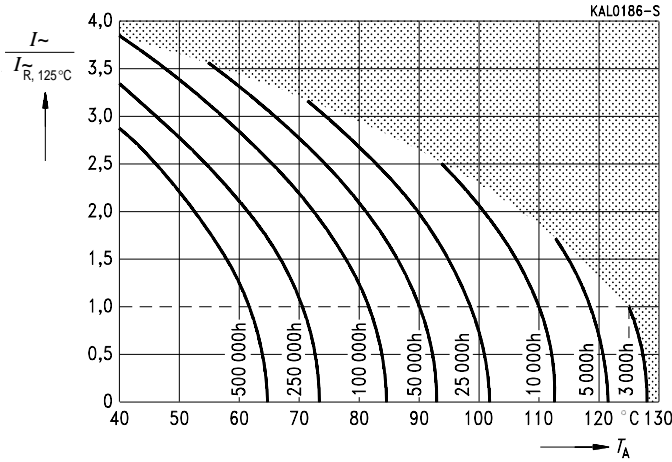

$d = 21 \text{ mm}, 25 \text{ mm}$

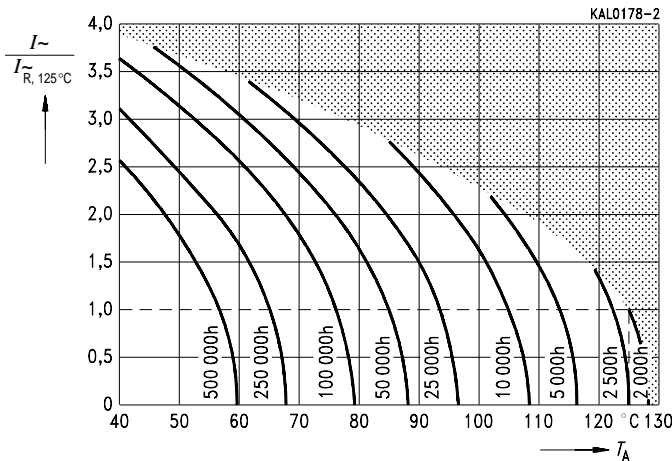

¹⁾ Refer to [page 34](#) for an explanation on how to interpret the useful life graphs.

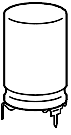

B 41 592

Permissible ripple current I_r versus frequency f

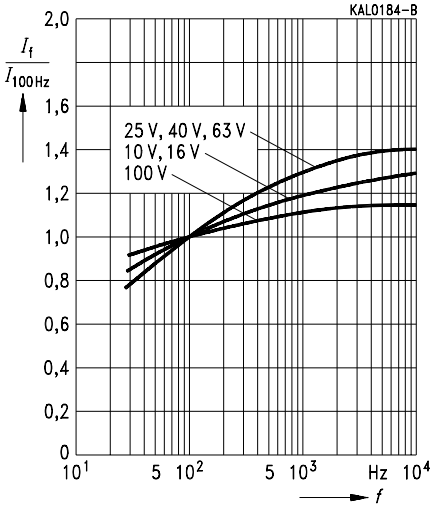

Series capacitance C_s at $f = 100$ Hz versus temperature T
Typical behavior

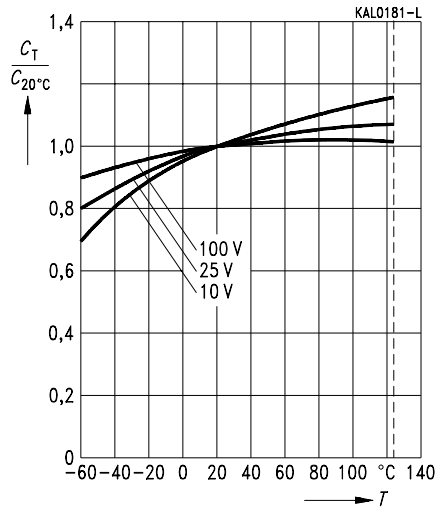

Equivalent series resistance R_{ESR} at $f = 100$ Hz versus temperature T
Typical behavior

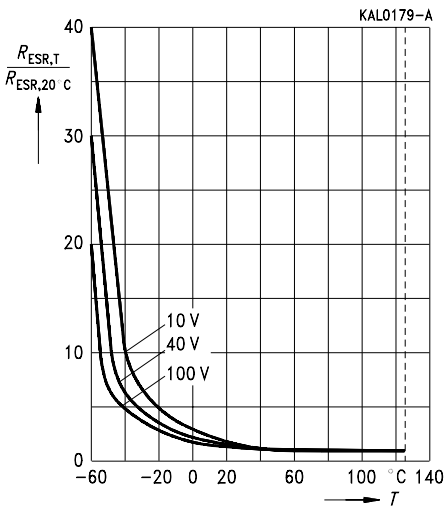

Impedance Z at 10 kHz versus temperature T
Typical behavior

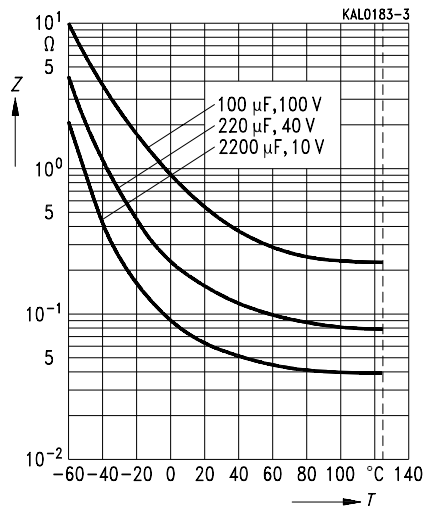

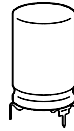

Impedance Z

versus frequency f
for $U_R = 40\text{ V}$ -, at 20°C
Typical behavior

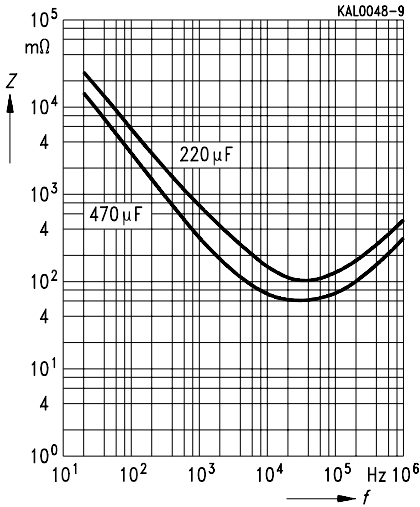

Impedance Z

versus frequency f
and temperature T for 470 $\mu\text{F}/40\text{ V}$ -
Typical behavior

