

**SIKOREL® 125, LL grade**

**Extremely high reliability and long useful life**

**Construction**

- Charge-discharge proof, polar
- Aluminum case with insulating sleeve
- Negative pole connected to case
- Axial leads, welded to ensure perfect electrical contact

**Features**

- Extremely high reliability and long useful life
- Very wide temperature range
- Can be operated at temperatures of up to 145 °C<sup>1)</sup>
- Outstanding parametric stability
- High ripple current capability
- Shelf life up to 10 years

**Applications**

- High-reliability equipment in industrial and automotive electronics

**Tape packaging**

Capacitors with  $d \leq 16$  mm are also available on tape.

Refer to [page 420](#) for information on tapes and examples on how to order them.

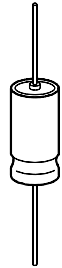

KAL0277-Z

**Specifications and characteristics in brief**

Rated voltage $U_R$	10 to 100 V–	
Surge voltage $U_S$	$1,15 \cdot U_R$	
Rated capacitance $C_R$	4,7 to 4 700 $\mu$ F	
Capacitance tolerance	– 10/+ 50 % $\triangleq$ T	
Useful life	$d \leq 10$ mm, $d = 21$ mm, 25 mm	$d \geq 12$ mm to 18 mm
	40 °C, $U_R$	> 200 000 h ( $3,2 \cdot I_{-R,125^\circ\text{C}}$ )
	85 °C, $U_R$ ; $I_{-max}$	> 15 000 h
	125 °C, $U_R$ ; $I_{-R}$	> 3 000 h
Failure percentage	$\leq 0,5$ % (during useful life)	
Failure rate	$\leq 10$ fit ( $\leq 10 \cdot 10^{-9}/\text{h}$ )	
Voltage endurance test	2 000 h, 125 °C (at $U_R$ )	

1) For capacitors with  $d \leq 18$  mm: operation at 145 °C and 0,6  $I_{-max}$  permissible for a total of 500 h.

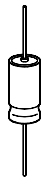

**Specifications and characteristics in brief**

Leakage current $I_{lka}$ (5 min, 20 °C)	$I_{lka} \leq 0,3 \mu A \cdot \left( \frac{C_R}{\mu F} \cdot \frac{U_R}{V} \right)^{0,7} + 4 \mu A$										
Self-inductance $L_{ESL}$	$d$ (mm)	6,5	8,5	10	12	14	16	18	21	25	
	$l$ (mm)	15,5	15,5	25	30	30	30	39,5	40	40	
	$L_{ESL}$ approx. (nH)	14	17	35	37	38	45	57	30	34	
IEC climatic category	in accordance with IEC 68-1 55/125/56 (–55 °C/+125 °C, 56 days damp heat test)										
Detail specification	similar to CECC 30 301-802										
Sectional specification	IEC 384-4										
Vibration resistance	in accordance with IEC 68-2–6, test Fc: displacement amplitude 0,75 mm, frequency range 10 to 55 Hz, acceleration max. 10 g, duration 3 × 2 h										

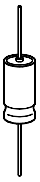

## B 41 590

### Dimensional drawing

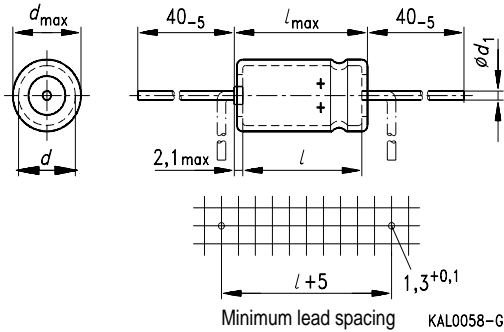

Dimensions (mm)		Lead wire diameter $d_1$	Approximate weight (g)
$d \times l$	$d_{max} \times l_{max}$		
6,5 × 15,5	7 × 17	0,6	1,1
8,5 × 15,5	9 × 17		1,8
10 × 25	10,5 × 26,5		3,2
12 × 30	12,5 × 32	0,8	5,4
14 × 30	14,5 × 32		7,5
16 × 30	16,5 × 32		9,3
18 × 39,5	18,5 × 40,3		14
21 × 40	21,5 × 41,5		18
25 × 40	25,5 × 41,5	26	

### Packing units

Case dimensions $d \times l$ (mm)	Bulk PU (pcs.)	Reel packing PU (pcs./reel)
6,5 × 15,5	2000	1300
8,5 × 15,5	1500	1000
10 × 25	900	600
12 × 30	600	450
14 × 30	400	350
16 × 30	350	250
18 × 39,5	250	—
21 × 40	200	—
25 × 40	150	—

Not for new design. For new design see type B 41 684, [page 409](#)

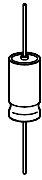

### Overview of available types

$U_R$ (V-)	10	16	25	40	63	100
$C_R$ ( $\mu$ F)	Case dimensions $d \times l$ (mm)					
4,7					6,5 × 15,5	8,5 × 15,5
10				6,5 × 15,5	8,5 × 15,5	8,5 × 15,5
22				8,5 × 15,5	8,5 × 15,5	10 × 25
47	6,5 × 15,5	8,5 × 15,5	8,5 × 15,5	8,5 × 15,5	10 × 25	12 × 30
100	8,5 × 15,5	8,5 × 15,5	10 × 25	10 × 25	12 × 30	16 × 30
220	10 × 25	10 × 25	12 × 30	12 × 30	16 × 30	18 × 39,5
470	12 × 30	12 × 30	14 × 30	16 × 30	18 × 39,5	25 × 40
1 000	14 × 30	16 × 30	18 × 39,5	21 × 40	25 × 40	
2 200	18 × 39,5	18 × 39,5	21 × 40	25 × 40		
4 700	25 × 40	25 × 40				

The capacitance and voltage ratings listed above are available in different cases upon request. Other voltage and capacitance ratings are also available upon request.

Not for new design. For new design see type B 41 684, [page 409](#)

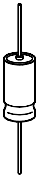

## B 41 590

### Technical data and ordering codes

$U_R$	$C_R$	Case dimensions $d \times l$ mm	$R_{ESR, typ}$ 100 Hz 20 °C $\Omega$	$R_{ESR, max}$ 100 Hz 20 °C $\Omega$	$Z_{max}$ 10 kHz 20 °C $\Omega$	$I_{\sim max}$ 100 Hz 40 °C A	$I_{\sim max}$ 100 Hz 85 °C A	$I_{\sim R}$ 100 Hz 125 °C A	Ordering code <sup>1)</sup>  Short code
<b>B41590-</b>									
10	47	6,5 × 15,5	2,9	5,6	1,8	0,32	0,22	0,08	-B3476-T90
	100	8,5 × 15,5	1,4	2,6	0,86	0,52	0,36	0,13	-B3107-T90
	220	10 × 25	0,63	1,2	0,42	0,96	0,67	0,24	-B3227-T90
	470	12 × 30	0,29	0,56	0,22	1,8	1,3	0,45	-A3477-T
	1 000	14 × 30	0,14	0,26	0,14	2,8	1,9	0,69	-A3108-T
	2 200	18 × 39,5	0,06	0,12	0,10	5,6	3,9	1,4	-A3228-T
	4 700	25 × 40	0,04	0,07	0,07	8,0	5,6	2,0	-A3478-T
16	47	8,5 × 15,5	2,5	4,8	1,6	0,40	0,28	0,10	-B4476-T90
	100	8,5 × 15,5	1,2	2,3	0,80	0,60	0,42	0,15	-B4107-T90
	220	10 × 25	0,53	1,0	0,40	1,1	0,78	0,28	-B4227-T90
	470	12 × 30	0,25	0,48	0,22	2,0	1,4	0,49	-A4477-T
	1 000	16 × 30	0,12	0,23	0,12	3,2	2,2	0,80	-A4108-T
	2 200	18 × 39,5	0,06	0,10	0,10	5,6	3,9	1,4	-A4228-T
	4 700	25 × 40	0,04	0,06	0,06	8,0	5,6	2,0	-A4478-T
25	47	8,5 × 15,5	2,0	3,7	1,6	0,44	0,31	0,11	-B5476-T90
	100	10 × 25	0,95	1,8	0,76	0,76	0,53	0,19	-B5107-T90
	220	12 × 30	0,41	0,79	0,38	1,5	1,1	0,38	-A5227-T
	470	14 × 30	0,20	0,37	0,20	2,3	1,6	0,58	-A5477-T
	1 000	18 × 39,5	0,10	0,18	0,12	4,0	2,8	1,0	-A5108-T
	2 200	21 × 40	0,05	0,10	0,10	6,4	4,5	1,6	-A5228-T

Not for new design. For new design see type B 41 684, [page 409](#)

1) To obtain the required ordering code, prefix the type number to the short code.  
E. g.: B41590-B3476-T90

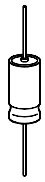

### Technical data and ordering codes

$U_R$	$C_R$	Case dimensions $d \times l$ mm	$R_{ESR, typ}$ 100 Hz 20 °C $\Omega$	$R_{ESR, max}$ 100 Hz 20 °C $\Omega$	$Z_{max}$ 10 kHz 20 °C $\Omega$	$I_{-max}$ 100 Hz 40 °C A	$I_{-max}$ 100 Hz 85 °C A	$I_{-R}$ 100 Hz 125 °C A	Ordering code <sup>1)</sup>  Short code
<b>B41590-</b>									
40	10	6,5 × 15,5	7,4	14	6,6	0,20	0,14	0,05	-B7106-T90
	22	8,5 × 15,5	3,4	6,4	3,0	0,36	0,25	0,09	-B7226-T90
	47	8,5 × 15,5	1,6	3,0	1,4	0,52	0,36	0,13	-B7476-T90
	100	10 × 25	0,74	1,4	0,72	0,92	0,64	0,23	-B7107-T90
	220	12 × 30	0,34	0,64	0,36	1,7	1,2	0,42	-A7227-T
	470	16 × 30	0,16	0,30	0,20	2,8	1,9	0,69	-A7477-T
	1 000	21 × 40	0,08	0,16	0,12	5,2	3,6	1,3	-A7108-T
	2 200	25 × 40	0,04	0,08	0,08	8,0	5,6	2,0	-A7228-T
63	4,7	6,5 × 15,5	14	26	13	0,16	0,11	0,04	-B8475-T90
	10	8,5 × 15,5	6,5	12	6,2	0,24	0,17	0,06	-B8106-T90
	22	8,5 × 15,5	2,9	5,6	2,8	0,36	0,25	0,09	-B8226-T90
	47	10 × 25	1,4	2,6	1,3	0,68	0,48	0,17	-B8476-T90
	100	12 × 30	0,63	1,2	0,66	1,2	0,87	0,31	-A8107-T
	220	16 × 30	0,31	0,56	0,34	2,0	1,4	0,50	-A8227-T
	470	18 × 39,5	0,14	0,26	0,18	3,5	2,5	0,88	-A8477-T
	1 000	25 × 40	0,08	0,14	0,12	5,6	3,9	1,4	-A8108-T
100	4,7	8,5 × 15,5	18	34	18	0,16	0,11	0,04	-B9475-T90
	10	8,5 × 15,5	8,3	16	8,4	0,24	0,17	0,06	-B9106-T90
	22	10 × 25	3,8	7,2	3,9	0,40	0,28	0,10	-B9226-T90
	47	12 × 30	1,8	3,4	1,9	0,72	0,50	0,18	-A9476-T
	100	16 × 30	0,79	1,5	0,90	1,2	0,87	0,31	-A9107-T
	220	18 × 39,5	0,38	0,72	0,50	2,2	1,5	0,54	-A9227-T
	470	25 × 40	0,20	0,38	0,30	3,5	2,5	0,88	-A9477-T

Not for new design. For new design see type B 41 684, [page 409](#)

1) To obtain the required ordering code, prefix the type number to the short code.  
E. g.: B41590-B7106-T90

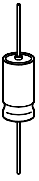

## B 41 590

### Useful life

versus ambient temperature  $T_A$  under ripple current operating conditions<sup>1)</sup>

$d \leq 10 \text{ mm}, 21 \text{ mm}, 25 \text{ mm}$

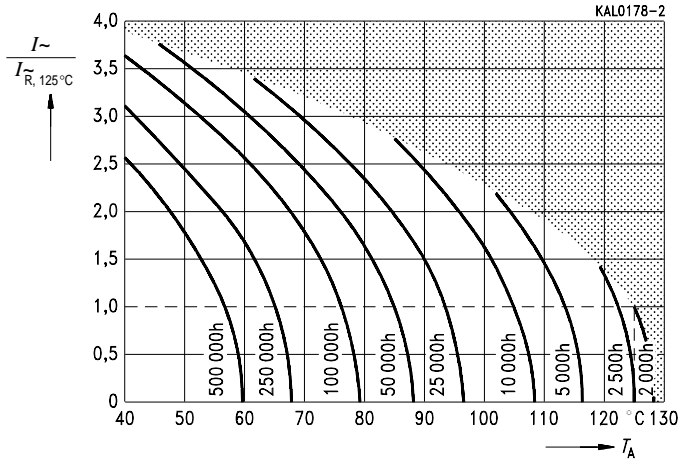

$d = 12 \text{ mm to } 18 \text{ mm}$

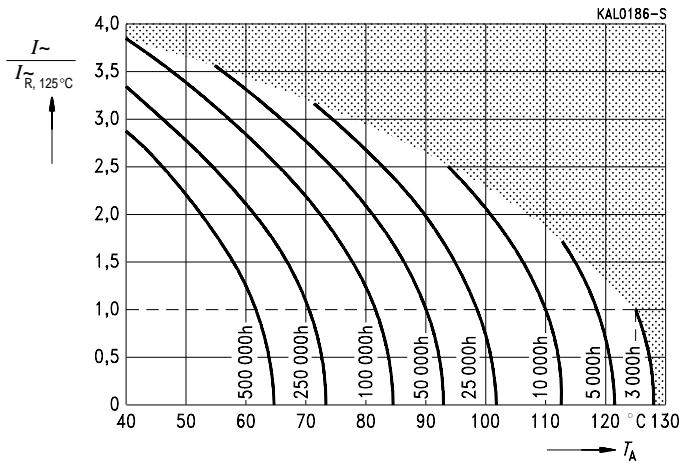

<sup>1)</sup> Refer to [page 34](#) for an explanation on how to interpret the useful life graphs.



**Permissible ripple current  $I_r$  versus frequency  $f$**

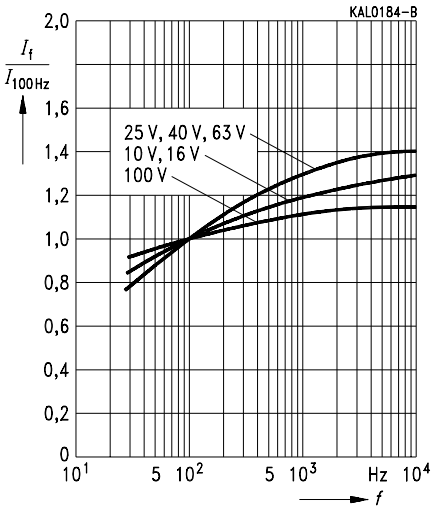

**Series capacitance  $C_S$  at  $f = 100$  Hz versus temperature  $T$**   
Typical behavior

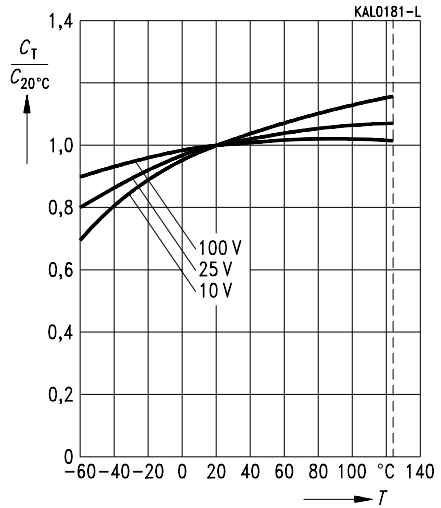

**Equivalent series resistance  $R_{\text{ESR}}$  at  $f = 100$  Hz versus temperature  $T$**   
Typical behavior

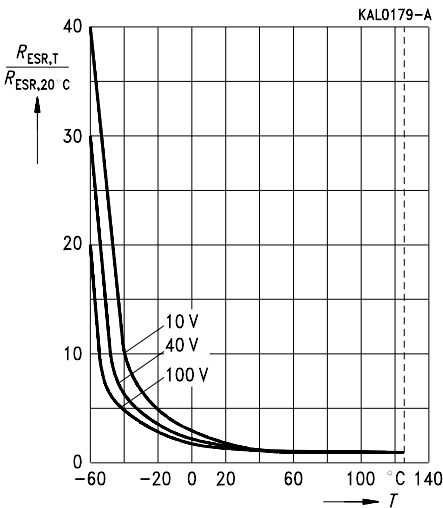

**Impedance  $Z$  at  $f = 100$  Hz versus temperature  $T$**   
Typical behavior

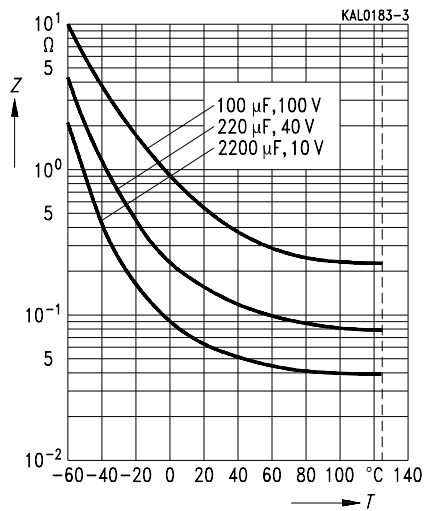



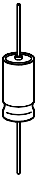

## B 41 590

### Impedance $Z$

versus frequency  $f$   
for  $U_R = 40\text{ V-}$ , at  $20^\circ\text{C}$   
Typical behavior

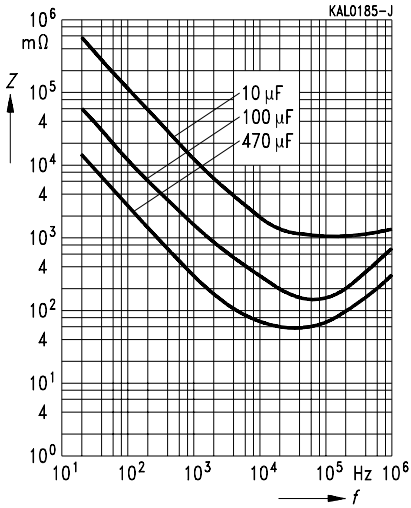

### Impedance $Z$

versus frequency  $f$   
and temperature  $T$  for  $470\ \mu\text{F}/40\text{ V-}$

