

LL grade

For professional switch-mode power supplies of compact design

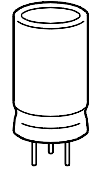

KAL0275-I

Construction

- Charge-discharge proof, polar
- Aluminum case with insulating sleeve
- Solder pin terminals brought out at one end to fit standardized PCB spacings
- Negative potential can be applied to third pin; this pin does not serve as a minus pole, however

Features

- Low equivalent series resistance R_{ESR}
- High reliability, high ripple current capability and small dimensions
- Long useful life
- Pinning ensures correct insertion

Applications

- For professional switch-mode power supplies of compact design
- General industrial electronics, telecommunications and data processing equipment

Specifications and characteristics in brief

	B 41 534	B 43 534
Rated voltage U_R	6,3 ... 100 V-	200 and 385 V-
Surge voltage U_S	$1,15 \cdot U_R$	$1,15 \cdot U_R$ (for $U_R \leq 200$ V-) $1,10 \cdot U_R$ (for $U_R = 385$ V-)
Rated capacitance C_R	100 ... 15 000 μ F	47 ... 220 μ F
Capacitance tolerance	$\pm 20\% \triangleq M$	$\pm 20\% \triangleq M$
Useful life		
40 °C, U_R	$> 200\,000$ h ($1,8 \cdot I_{-R,85^\circ C}$)	$> 200\,000$ h ($1,8 \cdot I_{-R,85^\circ C}$)
85 °C, U_R ; I_{-R}	$> 8\,000$ h	$> 8\,000$ h
Failure percentage	$\leq 0,5\%$ (during useful life)	$\leq 0,5\%$ (during useful life)
Failure rate	≤ 20 fit ($\leq 20 \cdot 10^{-9}$ /h)	≤ 20 fit ($\leq 20 \cdot 10^{-9}$ /h)
Voltage endurance test	3 000 h, 85 °C (at U_R)	3 000 h, 85 °C (at U_R)
Leakage current I_{kA} (5 min, 20 °C)	$I_{kA} \leq 0,3 \mu A \cdot \left(\frac{C_R}{\mu F} \cdot \frac{U_R}{V} \right)^{0,7} + 4 \mu A$	
Self-inductance L_{ESL}	approx. 10 nH	
IEC climatic category	in accordance with IEC 68-1 40/085/56 (- 40 °C/+ 85 °C, 56 days damp heat test)	

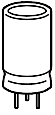

B 41 534
B 43 534

Not for new design

Specifications and characteristics in brief

	B 41 534	B 43 534
Detail specification	—	
Sectional specification	IEC 384–4	
Vibration resistance	in accordance with IEC 68–2–6, test Fc: displacement amplitude 0,35 mm, frequency range 10 ... 55 Hz, acceleration max. 5 g, duration 3 × 2 h	

Dimensional drawing

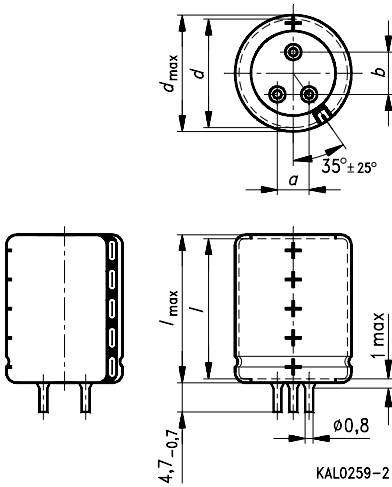

Dimensions (mm)				Approximate weight (g)	Packing units (pieces)
$d \times l$	$d_{max} \times l_{max}$	$a \begin{smallmatrix} +0,4 \\ -0,2 \end{smallmatrix}$	$b \begin{smallmatrix} +0,4 \\ -0,2 \end{smallmatrix}$		
18 × 30	18,8 × 30,5	5	7,5	11	600
18 × 40 ¹⁾	18,8 × 40,5	5	7,5	14	600
22 × 40 ²⁾	22,8 × 40,5	7,5	10	18	256
25 × 40	25,8 × 40,5	7,5	10	26	256

1) Also available with $d \times l = 22 \times 30$ mm
 2) Also available with $d \times l = 25 \times 30$ mm
 Ordering code: B41534-J★★★★-M (6,3 ... 100 V–)
 B43534-J★★★★-M (200 V–)
 B43534-N★★★★-M (385 V–)



Overview of available types

Type B 41 534

U_R (V-)	6,3	10	16	25	40	63	100
C_R (μ F)	Case dimensions $d \times l$ (mm)						
100							18 × 30
150							18 × 30
220						18 × 30	18 × 40
330						18 × 30	22 × 40
470					18 × 30	18 × 40	25 × 40
680					18 × 30	22 × 40	
1 000				18 × 30	18 × 40	25 × 40	
1 500			18 × 30	18 × 40	22 × 40		
2 200			18 × 30	22 × 40	25 × 40		
3 300		18 × 30	18 × 40	25 × 40			
4 700	18 × 30	18 × 40	22 × 40	25 × 40			
6 800	18 × 40	22 × 40	25 × 40				
10 000	22 × 40	25 × 40					
15 000	25 × 40						

Type B 43 534

U_R (V-)	200	385
C_R (μ F)	Case dimensions $d \times l$ (mm)	
47	18 × 30	18 × 40
68	18 × 40	22 × 40
100	22 × 40	25 × 40
150	22 × 40	25 × 40
220	25 × 40	

The capacitance and voltage ratings listed above are available in different cases upon request. Other voltage and capacitance ratings are also available upon request.

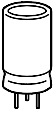

B 41 534
B 43 534

Not for new design

Technical data and ordering codes

U_R	C_R	Case dimensions $d \times l$ mm	$R_{ESR, typ}$ 20 kHz 20 °C mΩ	$R_{ESR, max}$ 20 kHz 20 °C mΩ	Z_{max} 200 kHz 20 °C mΩ	I_{-max} 20 kHz 40 °C A	I_{-R} 20 kHz 85 °C A	Ordering code ¹⁾
V-	μF							Short code
B41534-								
6,3	4 700	18 × 30	27	31	30	6,3	2,2	-A2478-M
	6 800	18 × 40	22	26	26	7,7	2,6	-A2688-M
	10 000	22 × 40	19	23	24	9,0	3,1	-A2109-M
	15 000	25 × 40	17	20	22	10,0	3,6	-A2159-M
10	3 300	18 × 30	27	32	30	6,2	2,1	-A3338-M
	4 700	18 × 40	23	27	27	7,6	2,6	-A3478-M
	6 800	22 × 40	19	23	24	9,0	3,1	-A3688-M
	10 000	25 × 40	17	21	22	10,0	3,5	-A3109-M
16	1 500	18 × 30	35	41	37	5,5	1,8	-A4158-M
	2 200	18 × 30	28	33	31	6,1	2,1	-A4228-M
	3 300	18 × 40	23	27	26	7,6	2,6	-A4338-M
	4 700	22 × 40	19	23	24	9,0	3,1	-A4478-M
	6 800	25 × 40	17	21	22	10,0	3,5	-A4688-M
25	1 000	18 × 30	32	37	36	5,8	2,0	-A5108-M
	1 500	18 × 40	25	30	30	7,2	2,4	-A5158-M
	2 200	22 × 40	21	25	26	8,6	3,0	-A5228-M
	3 300	25 × 40	18	22	23	9,9	3,4	-A5338-M
	4 700	25 × 40	16	20	22	10,0	3,6	-A5478-M
40	470	18 × 30	44	50	44	5,0	1,7	-A7477-M
	680	18 × 30	34	39	36	5,6	1,9	-A7687-M
	1 000	18 × 40	27	32	30	7,0	2,4	-A7108-M
	1 500	22 × 40	22	26	26	8,5	2,9	-A7158-M
	2 200	25 × 40	19	23	23	9,7	3,3	-A7228-M
63	220	18 × 30	57	65	54	4,4	1,5	-A8227-M
	330	18 × 30	42	48	42	5,1	1,7	-A8337-M
	470	18 × 40	33	38	35	6,4	2,2	-A8477-M
	680	22 × 40	27	31	30	7,7	2,7	-A8687-M
	1 000	25 × 40	22	26	26	9,1	3,1	-A8108-M

1) For instructions on how to determine ordering codes, refer to [page 261](#).



Technical data and ordering codes

U_R	C_R	Case dimensions $d \times l$	$R_{ESR, typ}$ 20 kHz 20 °C	$R_{ESR, max}$ 20 kHz 20 °C	Z_{max} 200 kHz 20 °C	I_{-max} 20 kHz 40 °C	I_{-R} 20 kHz 85 °C	Ordering code ¹⁾
V-	μF	mm	m Ω	m Ω	m Ω	A	A	Short code

B41534-

100	100	18 × 30	90	115	85	2,9	1,0	-A9107-M
	150	18 × 30	65	77	62	3,5	1,2	-A9157-M
	220	18 × 40	48	55	48	4,4	1,5	-A9227-M
	330	22 × 40	36	40	37	5,2	1,8	-A9337-M
	470	25 × 40	28	32	31	7,0	2,4	-A9477-M

B43534-

200	47	18 × 30	520	1300	1100	1,1	0,36	-A476-M
	68	18 × 40	360	900	780	1,6	0,55	-A686-M
	100	22 × 40	250	630	540	2,1	0,71	-A107-M
	150	22 × 40	170	430	360	2,5	0,86	-A157-M
	220	25 × 40	120	300	250	3,5	1,2	-A227-M
385	47	18 × 40	440	1100	950	1,5	0,51	-E476-M
	68	22 × 40	310	780	670	1,9	0,63	-E686-M
	100	25 × 40	210	530	460	2,6	0,89	-E107-M
	150	25 × 40	150	380	310	3,1	1,1	-E157-M

1) To obtain the required ordering code, prefix the type number to the short code. E. g.: B43534-A9107-M

B41534-... ($U_R = 6,3 \dots 100 \text{ V-}$);

B43534-... ($U_R = 200 \dots 385 \text{ V-}$)

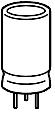

B 41 534
B 43 534

Not for new design

Useful life

versus ambient temperature T_A under ripple current operating conditions ¹⁾

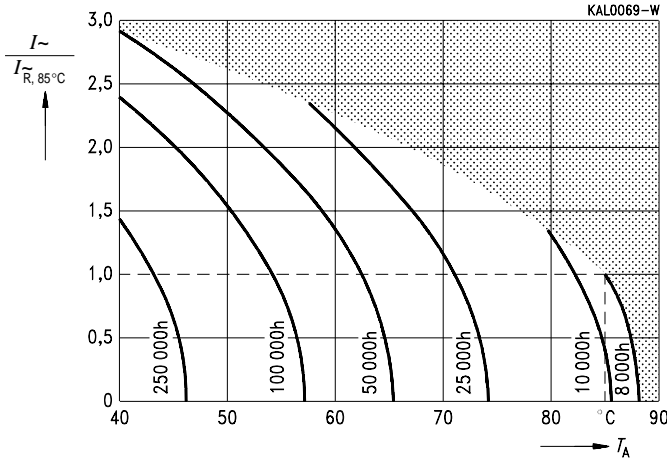

Permissible ripple current I_r
versus frequency f
Typical behavior

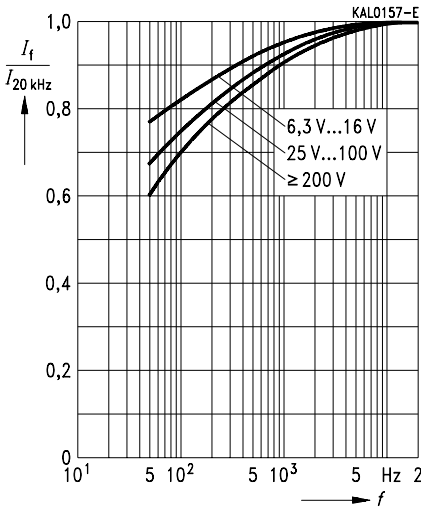

Series capacitance C_s at $f = 100$ Hz
versus temperature T
Typical behavior

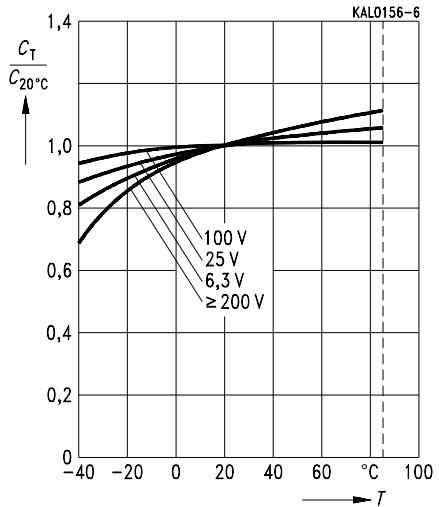

1) Refer to [page 34](#) for an explanation on how to interpret the useful life graphs.

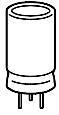

Equivalent series resistance R_{ESR}
at 100 Hz versus temperature T
Typical behavior

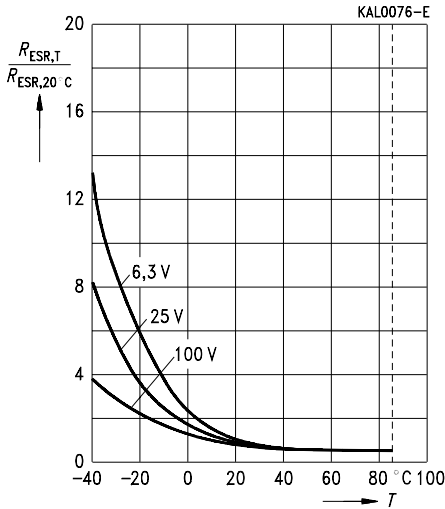

Equivalent series resistance R_{ESR}
versus frequency f
Typical behavior

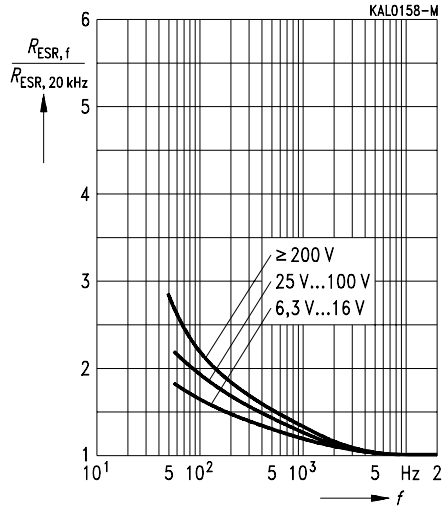

Impedance Z
versus frequency f
for $U_R = 25 V$ – at $20^\circ C$
Typical behavior

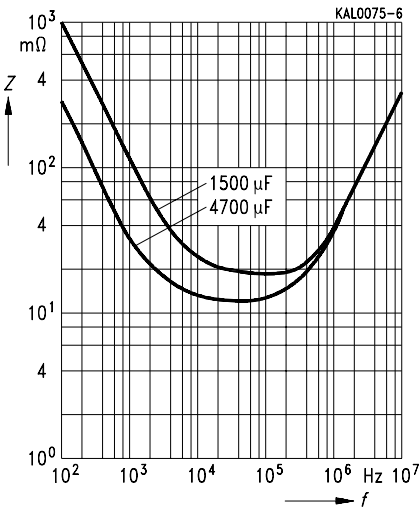

Impedance Z at 20 kHz
versus temperature T
Typical behavior

