

LL grade

Product series with very low self-inductance

Construction

- Charge-discharge proof, polar
- Aluminum case with insulating sleeve
- Solder pin terminals brought out at one end to fit standardized PCB spacings
- Negative potential can be applied to third pin; this pin does not serve as a minus pole, however

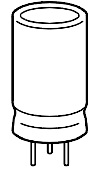

KAL0275-I

Features

- Very low self-inductance
- Very low equivalent series resistance R_{ESR}
- High ripple current capability and small dimensions
- Long useful life
- Operation at temperatures up to 105 °C ¹⁾
- Pinning ensures correct insertion

Applications

- Best suited for switch-mode power supplies with high clock frequencies
- For all types of equipment with high operating frequencies

Specifications and characteristics in brief

Rated voltage U_R	6,3 ... 100 V-
Surge voltage U_S	$1,15 \cdot U_R$
Rated capacitance C_R	100 ... 15 000 μ F
Capacitance tolerance	- 10/+ 50 % $\hat{=}$ T
Useful life	
40 °C, U_R	> 200 000 h ($1,8 \cdot I_{-R,85^\circ C}$)
85 °C, U_R ; I_{-max}	> 8 000 h
Failure percentage	$\leq 0,5$ % (during useful life)
Failure rate	≤ 20 fit ($\leq 20 \cdot 10^{-9}$ /h)
Voltage endurance test	3 000 h, 85 °C (at U_R)
Leakage current I_{lka} (5 min, 20 °C)	$I_{lka} \leq 0,3 \mu A \cdot \left(\frac{C_R}{\mu F} \cdot \frac{U_R}{V} \right)^{0,7} + 4 \mu A$
Self-inductance L_{ESL}	approx. 5 nH

1) Up to a total of 500 h operation at 105 °C permissible.

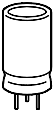

B 41 336

Not for new design

Specifications and characteristics in brief

IEC climatic category	in accordance with IEC 68-1 40/085/56 (– 40 °C/+ 85 °C, 56 days damp heat test)
Detail specification	–
Sectional specification	IEC 384-4
Vibration resistance	in accordance with IEC 68-2-6, test Fc: displacement amplitude 0,35 mm, frequency range 10 ... 55 Hz, acceleration max. 5 g, duration 3 × 2 h

Dimensional drawing

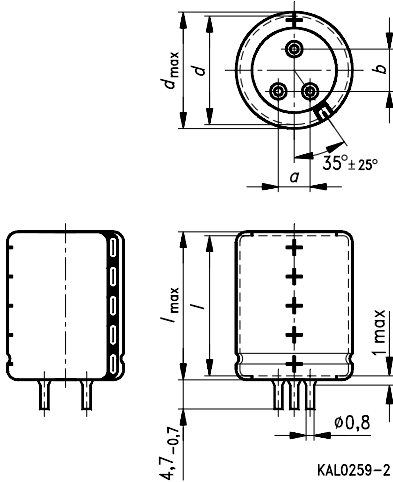

Dimensions (mm)				Approximate weight (g)	Packing units (pieces)
$d \times l$	$d_{max} \times l_{max}$	$a^{+0.4}_{-0.2}$	$b^{+0.4}_{-0.2}$		
18 × 30	18,8 × 30,5	5	7,5	11	600
18 × 40 ¹⁾	18,8 × 40,5	5	7,5	14	600
22 × 40 ²⁾	22,8 × 40,5	7,5	10	18	256
25 × 40	25,8 × 40,5	7,5	10	26	256

1) Also available with $d \times l = 22 \times 30$ mm; ordering code: B41336-J★★★★-T
 2) Also available with $d \times l = 25 \times 30$ mm; ordering code: B41336-J★★★★-T
 The electrical values may differ slightly from the ones specified above.



Overview of available types

U_R (V-)	6,3	10	16	25	40	63	100
C_R (μ F)	Case dimensions $d \times l$ (mm)						
100							18 × 30
150							18 × 30
220						18 × 30	18 × 40
330						18 × 30	22 × 40
470					18 × 30	18 × 40	25 × 40
680					18 × 30	22 × 40	
1 000				18 × 30	18 × 40	25 × 40	
1 500			18 × 30	18 × 40	22 × 40		
2 200			18 × 30	22 × 40	25 × 40		
3 300		18 × 30	18 × 40	25 × 40			
4 700	18 × 30	18 × 40	22 × 40	25 × 40			
6 800	18 × 40	22 × 40	25 × 40				
10 000	22 × 40	25 × 40					
15 000	25 × 40						

The capacitance and voltage ratings listed above are available in different cases upon request. Other voltage and capacitance ratings are also available upon request.

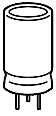

B 41 336

Not for new design

Technical data and ordering codes

U_R	C_R	Case dimensions $d \times l$ mm	$R_{ESR, typ}$ 20 kHz 20 °C mΩ	$R_{ESR, max}$ 20 kHz 20 °C mΩ	Z_{max} 200 kHz 20 °C mΩ	I_{-max} 20 kHz 40 °C A	I_{-R} 20 kHz 85 °C A	Ordering code ¹⁾ Short code
6,3	4 700	18 × 30	26	30	30	6,7	2,3	-A2478-T
	6 800	18 × 40	22	25	25	7,9	2,7	-A2688-T
	10 000	22 × 40	18	20	22	9,7	3,3	-A2109-T
	15 000	25 × 40	16	18	20	11,0	3,8	-A2159-T
10	3 300	18 × 30	26	31	30	6,4	2,2	-A3338-T
	4 700	18 × 40	23	26	25	7,7	2,6	-A3478-T
	6 800	22 × 40	18	21	22	9,4	3,2	-A3688-T
	10 000	25 × 40	17	19	20	10,7	3,7	-A3109-T
16	1 500	18 × 30	34	40	36	5,8	2,0	-A4158-T
	2 200	18 × 30	27	32	30	6,4	2,2	-A4228-T
	3 300	18 × 40	23	27	25	7,6	2,6	-A4338-T
	4 700	22 × 40	19	22	22	9,2	3,2	-A4478-T
	6 800	25 × 40	17	19	20	10,7	3,7	-A4688-T
25	1 000	18 × 30	31	36	35	6,1	2,1	-A5108-T
	1 500	18 × 40	25	29	26	7,3	2,5	-A5158-T
	2 200	22 × 40	20	23	22	9,0	3,1	-A5228-T
	3 300	25 × 40	18	22	22	9,9	3,4	-A5338-T
	4 700	25 × 40	16	20	21	10,4	3,6	-A5478-T
40	470	18 × 30	43	49	43	5,2	1,8	-A7477-T
	680	18 × 30	33	38	35	5,8	2,0	-A7687-T
	1 000	18 × 40	27	31	26	7,1	2,4	-A7108-T
	1 500	22 × 40	22	25	23	8,6	3,0	-A7158-T
	2 200	25 × 40	19	22	21	9,9	3,4	-A7228-T
63	220	18 × 30	56	64	53	4,4	1,5	-A8227-T
	330	18 × 30	41	47	40	5,2	1,8	-A8337-T
	470	18 × 40	33	38	30	6,4	2,2	-A8477-T
	680	22 × 40	27	30	26	7,9	2,7	-A8687-T
	1 000	25 × 40	22	26	25	9,1	3,1	-A8108-T
100	100	18 × 30	98	220	180	2,8	0,95	-A9107-T
	150	18 × 30	69	160	130	3,2	1,1	-A9157-T
	220	18 × 40	53	120	100	4,1	1,4	-A9227-T
	330	22 × 40	39	88	78	5,2	1,8	-A9337-T
	470	25 × 40	31	71	66	6,4	2,2	-A9477-T

1) To obtain the required ordering code, prefix the type number to the short code. E. g.: B41336-A2478-T

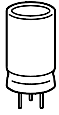

Useful life

versus ambient temperature T_A under ripple current operating conditions ¹⁾

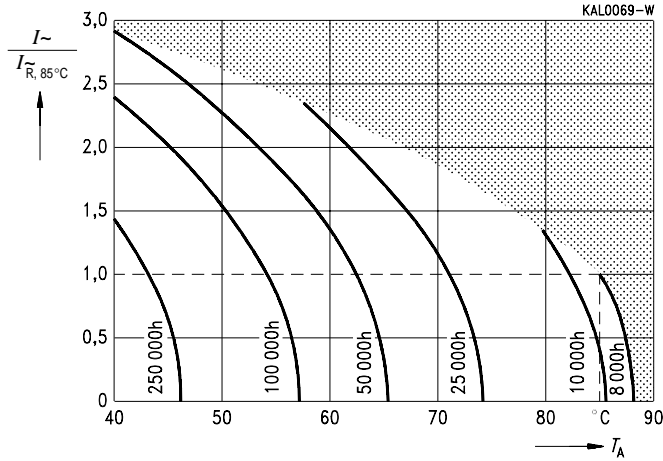

Permissible ripple current I_-
versus frequency f
Typical behavior

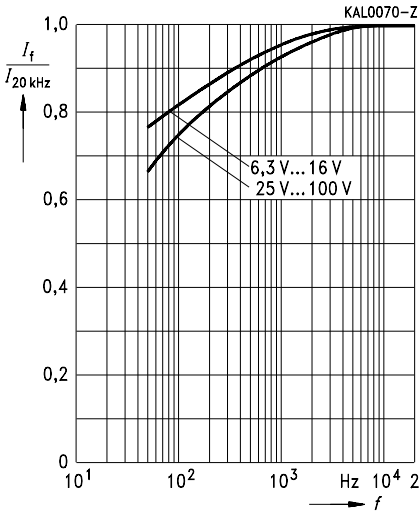

Series capacitance C_s at $f = 100$ Hz
versus temperature T
Typical behavior

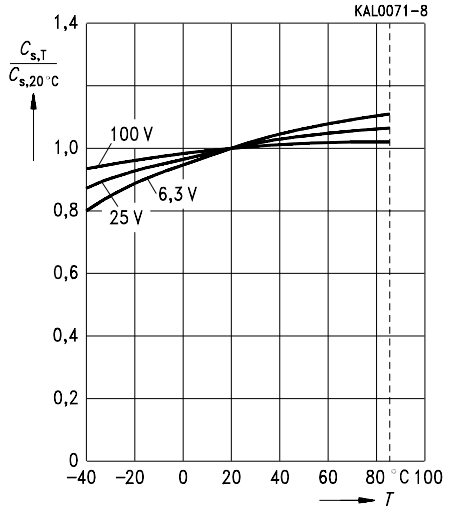

1) Refer to [page 34](#) for an explanation on how to interpret the useful life graphs.

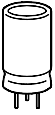

B 41 336

Not for new design

Equivalent series resistance R_{ESR}
at 100 Hz versus temperature T
Typical behavior

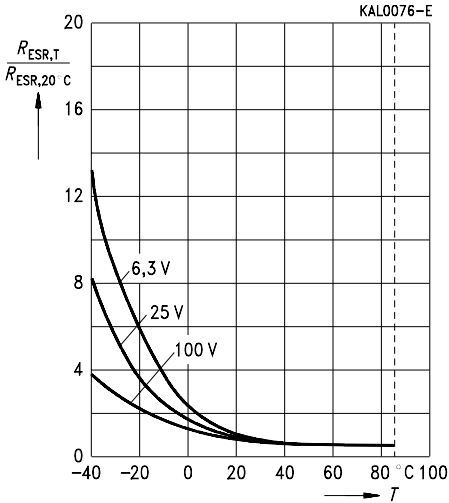

Equivalent series resistance R_{ESR}
versus frequency f
Typical behavior

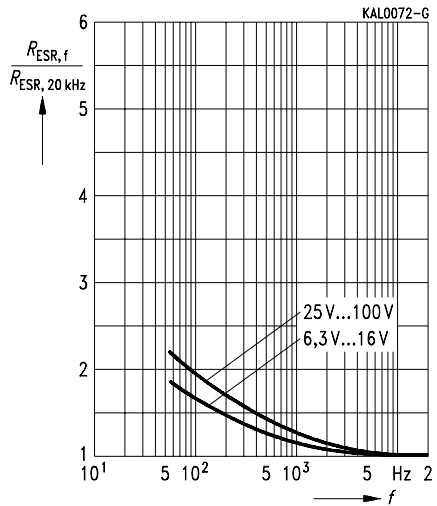

Impedance Z
versus frequency f
for $U_R = 25\text{ V}$ – at 20°C
Typical behavior

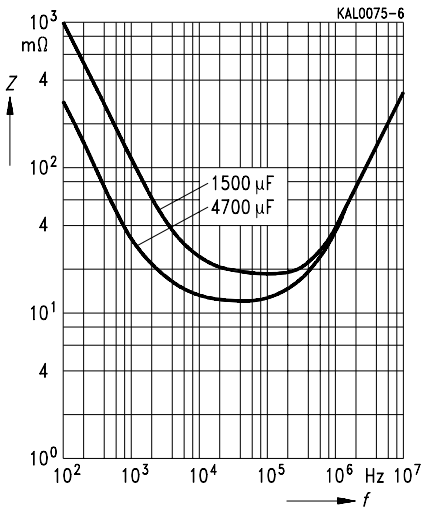

Impedance Z at 20 kHz
versus temperature T
Typical behavior

