

GP grade
For universal application
Construction

- Charge-discharge proof, polar
- Aluminum case, fully insulated
- Snap-in solder pins to hold component in place on PC-board
- Minus pole marking on case surface
- Minus pole not insulated from case

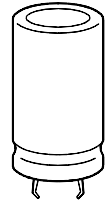

KAL0274-A

Terminals

- Standard version with 2 terminals
2 lengths available: 6,3 and 4,5 mm
- 3 terminals (terminal arrangement ensures correct insertion)

Features

- High ripple current capability
- High CU product, i. e. extremely compact
- Different case sizes available for each capacitance value

Applications

- Switch-mode power supplies in industrial and entertainment electronics

Specifications and characteristics in brief

	B 41 303	B 43 303
Rated voltage U_R	10 ... 100 V-	200 ... 550 V-
Surge voltage U_S	$1,15 \cdot U_R$	$1,15 \cdot U_R$ (for $U_R \leq 250$ V-) $1,10 \cdot U_R$ (for $U_R \geq 385$ V-)
Rated capacitance C_R	680 ... 47 000 μ F	15 ... 1 500 μ F
Capacitance tolerance	$\pm 20 \% \triangleq M$	$\pm 20 \% \triangleq M$
Useful life		
40 °C, U_R	$> 100\,000$ h ($1,3 \cdot I_{-R,85^\circ C}$)	$> 100\,000$ h ($1,3 \cdot I_{-R,85^\circ C}$)
85 °C, U_R ; I_{-R}	$> 2\,000$ h	$> 2\,000$ h
Failure percentage	$\leq 1 \%$ (during useful life)	$\leq 1 \%$ (during useful life)
Failure rate	≤ 100 fit ($\leq 100 \cdot 10^{-9}/h$)	≤ 100 fit ($\leq 100 \cdot 10^{-9}/h$)
Voltage endurance test	2 000 h, 85 °C (at U_R)	2 000 h, 85 °C (at U_R)
Leakage current I_{lka} (5 min, 20 °C)	$I_{lka} \leq 0,3 \mu A \cdot \left(\frac{C_R}{\mu F} \cdot \frac{U_R}{V} \right)^{0,7} + 4 \mu A$	

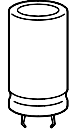
B 41 303
B 43 303
Specifications and characteristics in brief

	B 41 303	B 43 303
Self-inductance L_{ESL}	approx. 20 nH	
IEC climatic category	in accordance with IEC 68-1 40/085/56 (-40 °C/+85 °C, 56 days damp heat test)	25/085/56 (-25 °C/+85 °C, 56 days damp heat test)
Detail specification	similar to CECC 30 301-806	
Sectional specification	IEC 384-4	
Vibration resistance	in accordance with IEC 68-2-6, test Fc: displacement amplitude 0,35 mm, frequency range 10 ... 55 Hz, acceleration max. 5 g, duration 3 × 2 h	

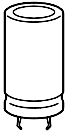

B 41 303

B 43 303

Dimensional drawings

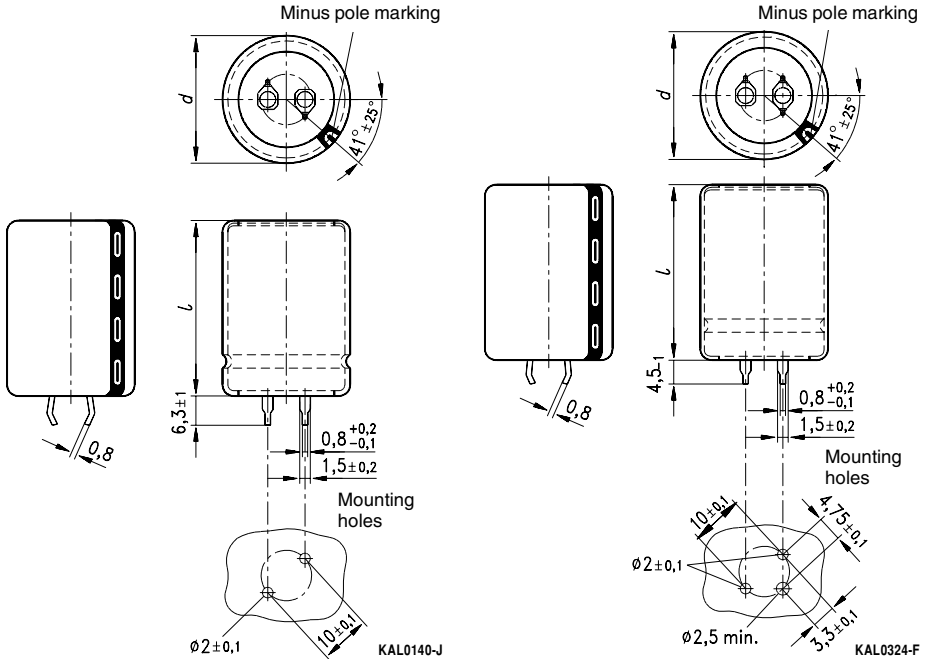

Snap-in terminals, standard (length $6,3 \pm 1$ mm). Also available in a shorter version with a length of $4,5 - 1$ mm. For packing mode and ordering example [see next page](#).

Snap-in capacitors are also available with 3 terminals. For packing mode and ordering example [see next page](#).

Dimensions (mm)		Approx. weight (g)	Packing units (pieces)
$d + 1$	$l \pm 2$		
22	25	9	160
22	30	12	160
22	35	15	160
22	40	18	160
22	45	20	160
25	25	13	130
25	30	17	130
25	35	19	130
25	40	22	130
25	45	25	130

Dimensions (mm)		Approx. weight (g)	Packing units (pieces)
$d + 1$	$l \pm 2$		
30	20	14	80
30	25	17	80
30	30	23	80
30	35	29	80
30	40	36	80
30	45	41	80
30	50	46	80
35	20	19	60
35	40	44	60
35	45	52	60
35	50	59	60
35	55	66	60

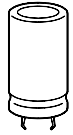

Packing

B 41 303

B 43 303

Packing of snap-in capacitors



For ecological reasons the packing is pure cardboard. Components can be withdrawn (in full or in part) in the correct position for insertion.

Ordering codes

Snap-in terminals Version	Identification in 3rd block of ordering code
Standard terminals (6,3 ± 1) mm	-M
Short terminals (4,5 – 1) mm	-M7
3 terminals	-M2

Ordering example:

B41303-A3109-M7 } snap-in capacitor with short terminals
 B41303-A3109-M2 } snap-in capacitor with 3 terminals

Overview of available types
Type B 41 303

U_R (V-)	10	16	25	40	63	100
C_R (μ F)	Case dimensions $d \times l$ (mm)					
680						22 × 30 25 × 25
1 000						22 × 35 25 × 30
1 500					22 × 30 25 × 25	25 × 35 30 × 30
2 200					22 × 35 25 × 30	30 × 35
3 300				22 × 30 25 × 25	25 × 35 30 × 30	30 × 45
4 700			22 × 30 25 × 25	22 × 35 25 × 30	30 × 35	
6 800		22 × 30 25 × 25	22 × 35 25 × 30	25 × 40 30 × 30	30 × 45	
10 000	22 × 30 25 × 25	22 × 35 25 × 30	25 × 35 30 × 30	30 × 35		
15 000	22 × 35 25 × 30	25 × 40 30 × 30	30 × 35	30 × 50		
22 000	25 × 40 30 × 30	30 × 35	30 × 45			
33 000	30 × 35	30 × 45				
47 000	30 × 45					

The capacitance and voltage ratings listed above are available in different cases upon request. Other voltage and capacitance ratings are also available upon request.

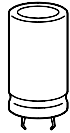
Overview of available types
Type B 43 303

U_R (V-)	200	250	385	400	450	500	550
C_R (μ F)	Case dimensions $d \times l$ (mm)						
15							22 × 25
22						22 × 25	22 × 30
33						22 × 30	22 × 40 25 × 30
47						22 × 40	25 × 40
68			22 × 25	22 × 30	22 × 35	25 × 40	30 × 40
100			22 × 30 25 × 25	22 × 35 25 × 30	22 × 40	30 × 40	30 × 50
120				25 × 30	25 × 35		
150		22 × 25	22 × 40 25 × 30	22 × 40 25 × 30	30 × 35	30 × 50	
180					30 × 35		
220	22 × 25	22 × 30 25 × 25	25 × 40 30 × 35	25 × 40 30 × 30	30 × 50		
270				30 × 35	30 × 45		
330	22 × 30 25 × 25	22 × 40 25 × 35	30 × 45	30 × 45	35 × 40		
390				30 × 45 35 × 40	35 × 45		
470	22 × 40 30 × 25	25 × 40 30 × 30	35 × 40	35 × 45	35 × 50		
560			35 × 45	35 × 50			
680	25 × 40 30 × 35	30 × 40		35 × 55			
1 000	30 × 45 35 × 40	35 × 45					
1 200	35 × 45	35 × 50					
1 500	35 × 50						

The capacitance and voltage ratings listed above are available in different cases upon request. Other voltage and capacitance ratings are also available upon request.



B 41 303

B 43 303

Technical data and ordering codes

U_R	C_R	Case dimensions $d \times l$ mm	$R_{ESR, max}$ 100 Hz 20 °C mΩ	Z_{max} 10 kHz 20 °C mΩ	$I_{\sim max}$ 100 Hz 40 °C A	$I_{\sim R}^{1)}$ 100 Hz 85 °C A	Ordering code ²⁾
V-	μF						Short code

B41303-

10	10 000	22 × 30	66	59	4,7	1,8	-A3109-M
	10 000	25 × 25	66	59	4,7	1,8	-J3109-M
	15 000	22 × 35	54	49	5,6	2,2	-B3159-M
	15 000	25 × 30	54	49	5,6	2,2	-J3159-M
	22 000	25 × 40	46	43	6,7	2,6	-A3229-M
	22 000	30 × 30	46	43	6,7	2,6	-J3229-M
	33 000	30 × 35	41	39	7,3	2,8	-B3339-M
	47 000	30 × 45	38	36	8,3	3,2	-B3479-M
16	6 800	22 × 30	71	59	4,5	1,8	-A4688-M
	6 800	25 × 25	71	59	4,5	1,8	-J4688-M
	10 000	22 × 35	58	52	5,2	2,0	-B4109-M
	10 000	25 × 30	58	52	5,2	2,0	-J4109-M
	15 000	25 × 40	49	45	6,4	2,5	-A4159-M
	15 000	30 × 30	49	45	6,4	2,5	-J4159-M
	22 000	30 × 35	43	40	7,3	2,8	-B4229-M
	33 000	30 × 45	39	37	8,1	3,1	-B4339-M
25	4 700	22 × 30	77	67	4,4	1,7	-A5478-M
	4 700	25 × 25	77	67	4,4	1,7	-J5478-M
	6 800	22 × 35	62	56	4,9	1,9	-B5688-M
	6 800	25 × 30	62	56	4,9	1,9	-J5688-M
	10 000	25 × 35	52	48	5,5	2,3	-B5109-M
	10 000	30 × 30	52	48	5,5	2,3	-J5109-M
	15 000	30 × 35	45	42	7,0	2,7	-B5159-M
	22 000	30 × 45	40	38	8,1	3,1	-B5229-M

1) 120 Hz conversion factor of ripple current: $I_{\sim} (120 \text{ Hz}) = 1,03 \cdot I_{\sim} (100 \text{ Hz})$

2) To obtain the required ordering code, prefix the type number to the short code. E. g.: B41303-A3109-M

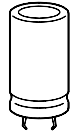
B 41 303
B 43 303
Technical data and ordering codes

U_R	C_R	Case dimensions $d \times l$ mm	$R_{ESR, \max}$ 100 Hz 20 °C mΩ	Z_{\max} 10 kHz 20 °C mΩ	$I_{\sim \max}$ 100 Hz 40 °C A	$I_{\sim R}^{1)}$ 100 Hz 85 °C A	Ordering code ²⁾
V-	μF						Short code

B41303-

40	3 300	22 × 30	77	71	4,4	1,7	-A7338-M
	3 300	25 × 25	77	71	4,4	1,7	-J7338-M
	4 700	22 × 35	66	59	4,9	1,9	-B7478-M
	4 700	25 × 30	66	59	4,9	1,9	-J7478-M
	6 800	25 × 40	55	50	6,1	2,4	-A7688-M
	6 800	30 × 30	55	50	6,1	2,4	-J7688-M
	10 000	30 × 35	47	44	6,8	2,6	-B7109-M
	15 000	30 × 50	41	39	8,4	3,3	-A7159-M
63	1 500	22 × 30	120	100	3,5	1,4	-A8158-M
	1 500	25 × 25	120	100	3,5	1,4	-J8158-M
	2 200	22 × 35	89	77	4,2	1,6	-B8228-M
	2 200	25 × 30	89	77	4,2	1,6	-J8228-M
	3 300	25 × 35	69	62	5,2	2,0	-B8338-M
	3 300	30 × 30	69	62	5,2	2,0	-J8338-M
	4 700	30 × 35	58	52	6,2	2,4	-B8478-M
	6 800	30 × 45	49	45	7,3	2,8	-B8688-M
100	680	22 × 30	180	150	2,9	1,1	-A9687-M
	680	25 × 25	180	150	2,9	1,1	-J9687-M
	1 000	22 × 35	130	110	3,4	1,3	-B9108-M
	1 000	25 × 30	130	110	3,4	1,3	-J9108-M
	1 500	25 × 35	97	83	4,4	1,7	-B9158-M
	1 500	30 × 30	97	83	4,4	1,7	-J9158-M
	2 200	30 × 35	75	66	5,5	2,1	-B9228-M
	3 300	30 × 45	60	54	6,5	2,5	-B9338-M

1) 120 Hz conversion factor of ripple current: $I_{\sim} (120 \text{ Hz}) = 1,03 \cdot I_{\sim} (100 \text{ Hz})$

2) To obtain the required ordering code, prefix the type number to the short code. E. g.: B41303-A7338-M



B 41 303

B 43 303

Technical data and ordering codes

U_R	C_R	Case dimensions $d \times l$ mm	$R_{ESR, max}$ 100 Hz 20 °C mΩ	Z_{max} 10 kHz 20 °C mΩ	$I_{~max}$ 100 Hz 40 °C A	$I_{~R}^{1)}$ 100 Hz 85 °C A	Ordering code ²⁾
V-	μF						Short code
B43303-							
200	220	22 × 25	1250	960	1,7	0,77	-D227-M
	330	22 × 30	900	640	2,2	1,0	-D337-M
	330	25 × 25	800	640	2,3	1,0	-M337-M
	470	22 × 40	560	450	2,9	1,3	-D477-M
	470	30 × 25	560	450	3,0	1,3	-M477-M
	680	25 × 40	390	310	3,8	1,7	-D687-M
	680	30 × 35	390	310	4,0	1,8	-M687-M
	1 000	30 × 45	260	210	5,3	2,4	-D108-M
	1 000	35 × 40	260	210	5,6	2,5	-E108-M
	1 200	35 × 45	220	180	6,4	2,9	-A128-M
1 500	35 × 50	180	140	7,4	3,3	-A158-M	
250	150	22 × 25	1400	1200	1,4	0,63	-C2157-M
	220	22 × 30	920	740	1,8	0,82	-C2227-M
	220	25 × 25	920	740	1,8	0,84	-L2227-M
	330	22 × 40	620	500	2,5	1,1	-C2337-M
	330	25 × 35	620	500	2,5	1,2	-L2337-M
	470	25 × 40	440	360	3,2	1,4	-C2477-M
	470	30 × 30	440	360	3,1	1,4	-L2477-M
	680	30 × 40	300	240	4,2	1,9	-C2687-M
	1 000	35 × 45	220	170	5,8	2,6	-A2108-M
	1 200	35 × 50	180	150	6,6	3,0	-A2128-M
385	68	22 × 25	2700	2200	1,0	0,45	-H686-M
	100	22 × 30	1800	1500	1,3	0,58	-H107-M
	100	25 × 25	1800	1500	1,3	0,59	-R107-M
	150	22 × 40	1200	940	1,7	0,79	-H157-M
	150	25 × 30	1200	940	1,7	0,77	-R157-M
	220	25 × 40	800	640	2,3	1,0	-H227-M
	220	30 × 35	800	640	2,4	1,1	-P227-M
	330	30 × 45	540	440	3,2	1,4	-H337-M
	470	35 × 40	410	330	4,1	1,8	-E477-M
	560	35 × 45	340	280	4,7	2,1	-A567-M

1) 120 Hz conversion factor of ripple current: $I_{~}(120 \text{ Hz}) = 1,03 \cdot I_{~}(100 \text{ Hz})$

2) To obtain the required ordering code, prefix the type number to the short code. E. g.: B43303-D227-M

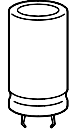
B 41 303
B 43 303
Technical data and ordering codes

U_R	C_R	Case dimensions $d \times l$ mm	$R_{ESR, \max}$ 100 Hz 20 °C mΩ	Z_{\max} 10 kHz 20 °C mΩ	$I_{\sim \max}$ 100 Hz 40 °C A	$I_{\sim R}^{1)}$ 100 Hz 85 °C A	Ordering code ²⁾
V-	μF						Short code

B43303-

400	68	22 × 30	2400	2000	1,0	0,48	-G686-M
	100	22 × 35	1600	1420	1,3	0,61	-G107-M
	100	25 × 30	1600	1420	1,4	0,63	-Q107-M
	120	25 × 30	1350	1180	1,5	0,69	-A9127-M
	150	22 × 40	1100	920	1,7	0,79	-A9157-M
	150	25 × 30	1100	920	1,7	0,77	-B9157-M
	220	25 × 40	700	630	2,2	1,0	-B9227-M
	220	30 × 30	700	630	2,2	1,0	-A9227-M
	270	30 × 35	580	520	2,6	1,2	-A9277-M
	330	30 × 45	450	420	3,2	1,4	-G337-M
	390	30 × 45	400	360	3,5	1,6	-A9397-M
	390	35 × 40	440	350	3,7	1,7	-A397-M
	470	35 × 45	360	290	4,3	1,9	-F477-M
	560	35 × 50	300	240	4,9	2,2	-F567-M
	680	35 × 55	250	200	5,6	2,5	-A687-M

1) 120 Hz conversion factor of ripple current: $I_{\sim} (120 \text{ Hz}) = 1,03 \cdot I_{\sim} (100 \text{ Hz})$

2) To obtain the required ordering code, prefix the type number to the short code. E. g.: B43303-G686-M.



B 41 303

B 43 303

Technical data and ordering codes

U_R	C_R	Case dimensions $d \times l$ mm	$R_{ESR, max}$ 100 Hz 20 °C mΩ	Z_{max} 10 kHz 20 °C mΩ	$I_{~max}$ 100 Hz 40 °C A	$I_{~R}^{1)}$ 100 Hz 85 °C A	Ordering code ²⁾
V-	μF						Short code

B43303-

450	68	22 × 35	3700	3080	1,1	0,50	-A5686-M
	100	22 × 40	2500	2080	1,4	0,64	-B5107-M
	120	25 × 35	2100	1730	1,6	0,72	-A5127-M
	150	30 × 35	1700	1420	1,9	0,88	-A5157-M
	180	30 × 35	1370	1180	2,1	0,97	-A5187-M
	220	30 × 50	1200	1000	2,7	1,2	-A5227-M
	270	30 × 45	910	790	2,9	1,3	-A5277-M
	330	35 × 40	840	670	3,4	1,5	-A5337-M
	390	35 × 45	710	570	3,9	1,8	-A5397-M
470	35 × 50	590	470	4,5	2,0	-A5477-M	
500	22	22 × 25	9200	7700	0,52	0,24	-A6226-M
	33	22 × 30	6200	5200	0,68	0,31	-A6336-M
	47	22 × 40	4400	3700	0,91	0,41	-A6476-M
	68	25 × 40	3000	2500	1,2	0,54	-A6686-M
	100	30 × 40	2100	1800	1,6	0,71	-A6107-M
	150	30 × 50	1400	1200	2,1	0,94	-A6157-M
550	15	22 × 25	14000	12000	0,43	0,20	-A7156-M
	22	22 × 30	9200	7700	0,56	0,25	-A7226-M
	33	22 × 40	6200	5200	0,76	0,35	-A7336-M
	33	25 × 30	6200	5200	0,74	0,34	-J7336-M
	47	25 × 40	4400	3700	0,98	0,45	-A7476-M
	68	30 × 40	3000	2500	1,3	0,58	-A7686-M
	100	30 × 50	2100	1800	1,7	0,77	-A7107-M

1) 120 Hz conversion factor of ripple current: $I_{~(120\text{ Hz})} = 1,03 \cdot I_{~(100\text{ Hz})}$

2) To obtain the required ordering code, prefix the type number to the short code. E. g.: B43303-A5686-M

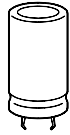

Useful life

versus ambient temperature T_A under ripple current operating conditions ¹⁾

$U_R \leq 100 \text{ V}$ –

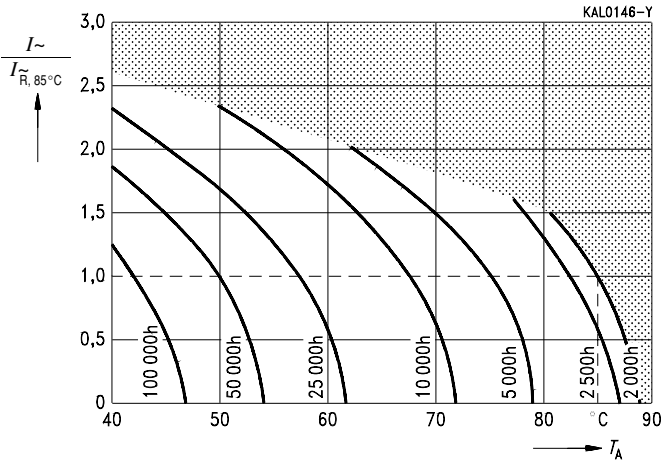

$U_R \geq 200 \text{ V}$ –

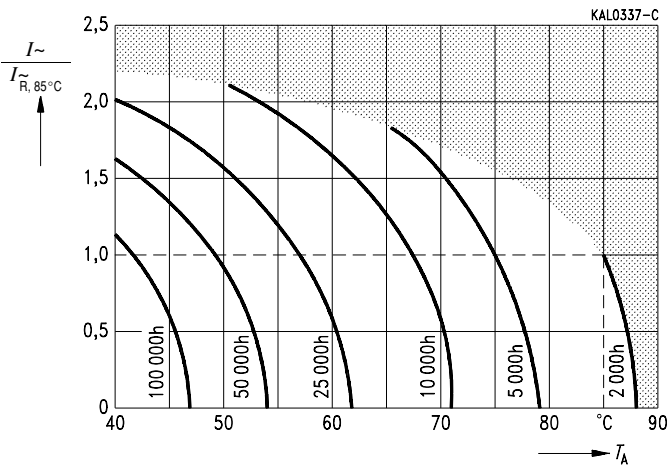

1) Refer to [page 31](#) for an explanation on how to interpret the useful life graphs.

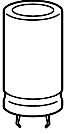

B 41 303

B 43 303

Permissible ripple current I_{\sim}
versus frequency f

$U_R \leq 100 \text{ V-}$

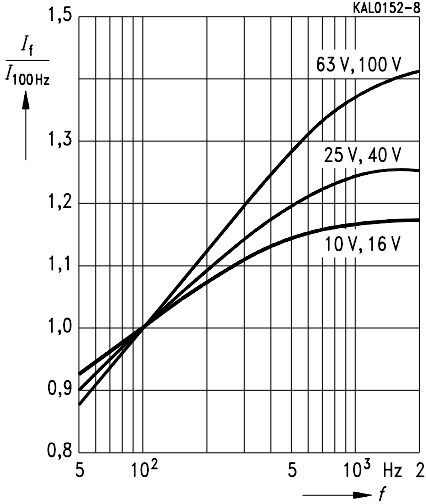

Permissible ripple current I_{\sim}
versus frequency f

$U_R \geq 200 \text{ V-}$

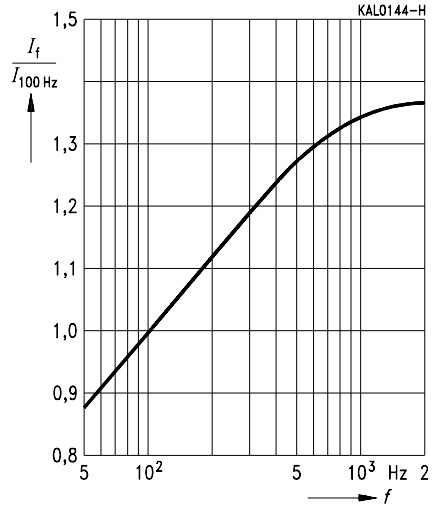

Equivalent series resistance R_{ESR}

versus frequency f

Typical behavior

$U_R \leq 100 \text{ V-}$

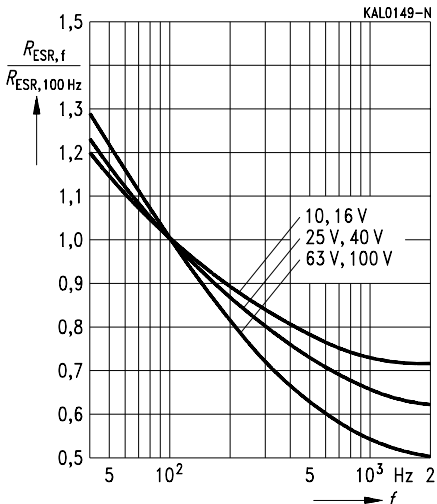

Equivalent series resistance R_{ESR}

versus frequency f

Typical behavior

$U_R \geq 200 \text{ V-}$

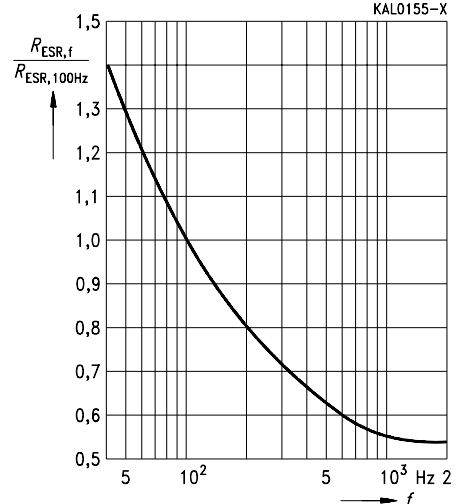

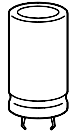

Impedance Z
 versus frequency f
 Typical behavior
 $U_R \leq 100 \text{ V}$

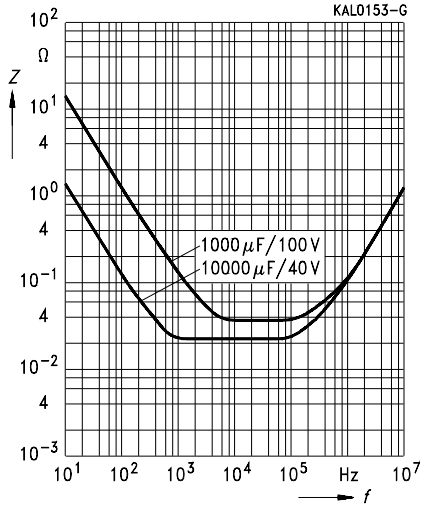

Impedance Z
 versus frequency f
 and temperature T for $100 \mu\text{F}/400 \text{ V}$ –
 Typical behavior

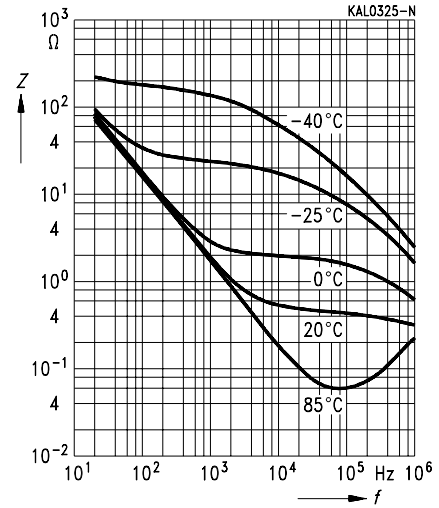

Herausgegeben von EPCOS AG

Marketing Kommunikation, Postfach 80 17 09, 81617 München, DEUTSCHLAND

© EPCOS AG 2000. Alle Rechte vorbehalten. Vervielfältigung, Veröffentlichung, Verbreitung und Verwertung dieser Broschüre und ihres Inhalts ohne ausdrückliche Genehmigung der EPCOS AG nicht gestattet.

Mit den Angaben in dieser Broschüre werden die Bauelemente spezifiziert, keine Eigenschaften zugesichert. Bestellungen unterliegen den vom ZVEI empfohlenen Allgemeinen Lieferbedingungen für Erzeugnisse und Leistungen der Elektroindustrie, soweit nichts anderes vereinbart wird.

Diese Broschüre ersetzt die vorige Ausgabe.

Fragen über Technik, Preise und Liefermöglichkeiten richten Sie bitte an den Ihnen nächstgelegenen Vertrieb der EPCOS AG oder an unsere Vertriebsgesellschaften im Ausland.

Bauelemente können aufgrund technischer Erfordernisse Gefahrstoffe enthalten. Auskünfte darüber bitten wir unter Angabe des betreffenden Typs ebenfalls über die zuständige Vertriebsgesellschaft einzuholen.

Published by EPCOS AG

Marketing Communications, P.O. Box 80 17 09, 81617 Munich, GERMANY

© EPCOS AG 2000. All Rights Reserved. Reproduction, publication and dissemination of this brochure and the information contained therein without EPCOS' prior express consent is prohibited.

The information contained in this brochure describes the type of component and shall not be considered as guaranteed characteristics. Purchase orders are subject to the General Conditions for the Supply of Products and Services of the Electrical and Electronics Industry recommended by the ZVEI (German Electrical and Electronic Manufacturers' Association), unless otherwise agreed.

This brochure replaces the previous edition.

For questions on technology, prices and delivery please contact the Sales Offices of EPCOS AG or the international Representatives.

Due to technical requirements components may contain dangerous substances. For information on the type in question please also contact one of our Sales Offices.