



Aluminum electrolytic capacitors

Snap-in capacitors

Series/Type: B41231

Date: December 2019

General-purpose grade capacitors

Applications

- Professional power supplies
- Not for automotive applications unless otherwise specified

Features

- High ripple current capability
- RoHS-compatible
- Useful life of 2000 h at 85 °C



Construction

- Aluminum case, fully insulated with PET
- Version with PVC insulation available upon request
- Snap-in solder pins to hold component in place on PC-board
- Minus pole marking on the insulating sleeve
- Minus pole not insulated from case
- Overload protection by safety vent on the base

Terminals

- Standard version with 2 terminals,
2 lengths available: 6.0 and 4.5 mm
- 3 terminals to ensure correct insertion: length 4.5 mm

Specifications and characteristics in brief

Rated voltage V_R	10 ... 100 V DC									
Surge voltage V_S	1.15 · V_R (at room temperature)									
Rated capacitance C_R	1200 ... 68000 μ F									
Capacitance tolerance	$\pm 20\%$ \triangleq M									
Dissipation factor (max.) (20 °C, 120 Hz)	V_R (V DC)	10	16	25	35	50	63	80	100	
	$\tan \delta$	0.50	0.50	0.40	0.40	0.30	0.25	0.20	0.15	
Leakage current I_{leak} (20 °C, after 5 minutes)	$I_{leak} \leq 0.02 \mu A \cdot \left(\frac{C_R}{\mu F} \cdot \frac{V_R}{V} \right)$									
Useful life ¹⁾ 85 °C; V_R ; $I_{AC,R}$	> 2000 h	Requirements:								
		$ \Delta C/C \leq 20\%$ of initial value $\tan \delta \leq 2$ times initial specified limit $I_{leak} \leq$ initial specified limit								
Vibration resistance test	To IEC 60068-2-6, test Fc: Frequency range 10 Hz ... 55 Hz, displacement amplitude 0.75 mm, acceleration max. 10 g, duration 3 × 2 h. Capacitor rigidly clamped by the aluminum case.									
Shelf life	After storage for 1000 h at 85 °C, the capacitors shall meet the requirement of load life test after reforming process. After test: V_R to be applied for 30 minutes, 24 to 48 hours before measurement.									
Characteristics at low temperature	Max. impedance ratio at 120 Hz	V_R	10 V			16 ... 100 V				
		$Z_{-25\text{ °C}} / Z_{20\text{ °C}}$	5			4				
		$Z_{-40\text{ °C}} / Z_{20\text{ °C}}$	18			15				
IEC climatic category	To IEC 60068-1: 25/085/56 (–25 °C/+85 °C/56 days damp heat test) The capacitors can be operated in the temperature range of –40 °C to +85 °C but the impedance at –40 °C must be taken into consideration.									
Sectional specification	IEC 60384-4									

1) Refer to chapter "General technical information, 5 Useful life" on how to interpret useful life.

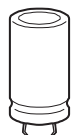

B41231

85 °C

Dimensional drawing

Snap-in capacitors with standard insulation (PET)

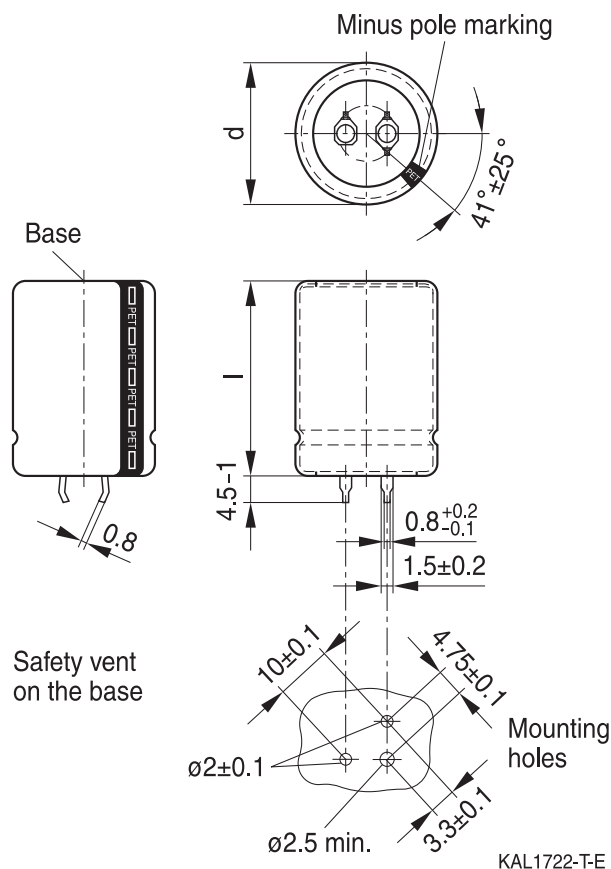
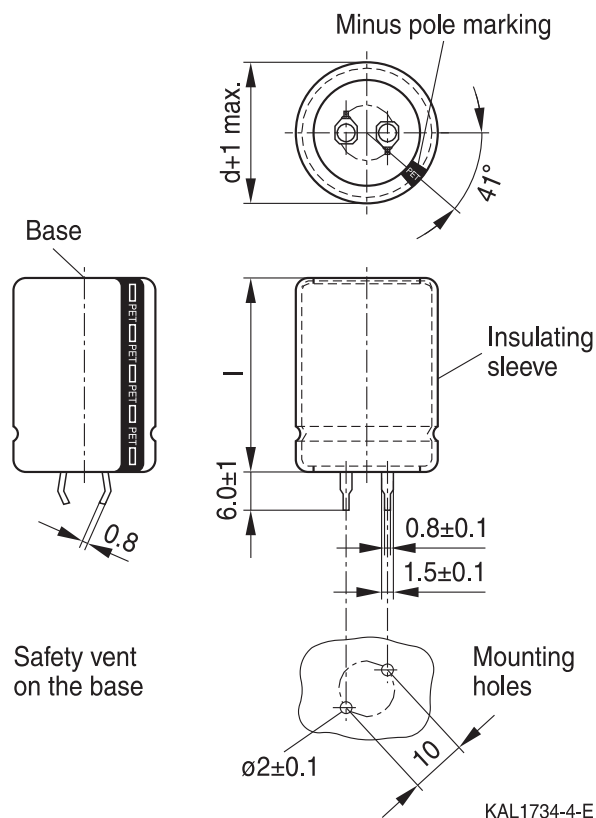

Snap-in terminals, length (6.0 ±1) mm.
Also available in a shorter version with a length of (4.5 – 1) mm. Insulation is marked with "PET" on the sleeve. Safety vent on the base.

Snap-in capacitors are also available with 3 terminals (length (4.5 – 1) mm). Insulation is marked with "PET" on the sleeve. Safety vent on the base.

Dimensions (mm)		Approx. weight (g)	Packing units (pcs.)
d +1	l ±2		
22	25	13.0	160
22	30	15.0	160
22	35	20.5	160
22	40	23.0	160
22	45	25.0	160
22	50	29.5	160
25.4	25	13.5	130
25.4	30	19.5	130
25.4	35	25.0	130
25.4	40	28.0	130
25.4	45	31.0	130
25.4	50	39.0	130

Dimensions (mm)		Approx. weight (g)	Packing units (pcs.)
d +1	l ±2		
30	25	24.5	80
30	30	25.5	80
30	35	32.5	80
30	40	39.0	80
30	45	43.5	80
30	50	55.5	80
35	25	35.0	60
35	30	43.0	60
35	35	50.5	60
35	40	52.0	60
35	45	65.0	60
35	50	70.5	60

B41231

85 °C



Ordering codes for terminal styles and insulation features

Identification in 3rd block of ordering code

Snap-in capacitors

Terminal version	Insulation
	PET
Standard terminals 6.0 mm	M060
Short terminals 4.5 mm	M067
3 terminals 4.5 mm	M062

Ordering examples:

- B41231A9478M067 } snap-in capacitor with short terminals and PET insulation
- B41231A9478M062 } snap-in capacitor with 3 terminals and PET insulation

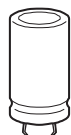

B41231

85 °C

Overview of available types

V_R (V DC)	10	16	25	35	50	63	80	100
	Case dimensions $d \times l$ (mm)							
C_R (μ F)								
1200							22 × 25	22 × 30 25.4 × 25
1500							22 × 30	22 × 35 25.4 × 30 30 × 25
1800						22 × 25	22 × 30 25.4 × 25	22 × 40 25.4 × 35 30 × 30
2200						22 × 30 25.4 × 25	22 × 35 25.4 × 30 30 × 25	22 × 45 25.4 × 40 30 × 30
2700						22 × 35 25.4 × 30	22 × 40 25.4 × 35 30 × 30	25.4 × 45 30 × 35 35 × 30
3300					22 × 30 25.4 × 25	22 × 35 25.4 × 30 30 × 25	22 × 45 25.4 × 40 30 × 30	25.4 × 50 30 × 40 35 × 35
3900						22 × 40 25.4 × 35 30 × 30	22 × 50 25.4 × 45 30 × 35	30 × 45 35 × 35
4700				22 × 30 25.4 × 25	22 × 40 25.4 × 35 30 × 25 35 × 25	22 × 50 25.4 × 40 30 × 35 35 × 30	25.4 × 50 30 × 40 35 × 30	30 × 50 35 × 40
5600			22 × 25	22 × 35 25.4 × 30	22 × 45 25.4 × 40 30 × 30 35 × 25	25.4 × 45 30 × 35 35 × 30	30 × 45 35 × 35	35 × 45
6800			22 × 30 25.4 × 25	22 × 40 25.4 × 30 30 × 25	22 × 50 25.4 × 45 30 × 35 35 × 30	25.4 × 50 30 × 40 35 × 30	35 × 40	
8200			22 × 35 25.4 × 30	22 × 45 25.4 × 35 30 × 30	25.4 × 50 30 × 40 35 × 30	30 × 45 35 × 35	35 × 45	

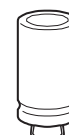
Overview of available types

V_R (V DC)	10	16	25	35	50	63	80	100
	Case dimensions $d \times l$ (mm)							
C_R (μF)								
10000		22 × 25	22 × 40 25.4 × 30	22 × 50 25.4 × 40 30 × 30	30 × 45 35 × 35	30 × 50 35 × 40		
12000	22 × 25	22 × 30 25.4 × 25	22 × 45 25.4 × 35 30 × 25	25.4 × 45 30 × 35 35 × 30	30 × 50 35 × 40	35 × 45		
15000	22 × 30 25.4 × 25	22 × 35 25.4 × 30 30 × 25	22 × 50 25.4 × 40 30 × 30	30 × 40 35 × 35	35 × 45			
18000	22 × 35 25.4 × 25	22 × 40 25.4 × 35 30 × 30	25.4 × 45 30 × 35	30 × 45 35 × 40	35 × 50			
22000	22 × 40 25.4 × 30 30 × 25	22 × 50 25.4 × 40 30 × 30	30 × 35 35 × 30	35 × 45				
27000	22 × 45 25.4 × 35 30 × 30	25.4 × 45 30 × 35 35 × 25	30 × 45 35 × 35					
33000	22 × 50 25.4 × 40 30 × 30 35 × 25	30 × 40 35 × 30	30 × 50 35 × 40					
39000	25.4 × 45 30 × 35 35 × 30	30 × 45 35 × 35	35 × 45					
47000	25.4 × 50 30 × 40 35 × 30	30 × 50 35 × 40						
56000	30 × 45 35 × 35	35 × 45						
68000	35 × 40	35 × 50						

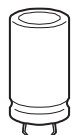

B41231

85 °C

Technical data and ordering codes

C_R 120 Hz 20 °C μF	Case dimensions $d \times l$ mm	$\tan \delta_{\max}$ 120 Hz 20 °C	$I_{AC,\max}$ 120 Hz 60 °C A	$I_{AC,R}$ 120 Hz 85 °C A	Ordering code (composition see below)
$V_R = 10 \text{ V DC}$					
12000	22 × 25	0.50	6.55	3.31	B41231A3129M06#
15000	22 × 30	0.50	7.56	3.82	B41231A3159M06#
15000	25.4 × 25	0.50	6.71	3.39	B41231B3159M06#
18000	22 × 35	0.50	8.47	4.28	B41231A3189M06#
18000	25.4 × 25	0.50	8.26	4.17	B41231B3189M06#
22000	22 × 40	0.50	9.48	4.79	B41231A3229M06#
22000	25.4 × 30	0.50	9.33	4.71	B41231B3229M06#
22000	30 × 25	0.50	9.56	4.83	B41231C3229M06#
27000	22 × 45	0.50	10.5	5.30	B41231A3279M06#
27000	25.4 × 35	0.50	10.4	5.26	B41231B3279M06#
27000	30 × 30	0.50	11.7	5.41	B41231C3279M06#
33000	22 × 50	0.50	11.5	5.82	B41231A3339M06#
33000	25.4 × 40	0.50	11.5	5.81	B41231B3339M06#
33000	30 × 30	0.50	11.2	5.69	B41231C3339M06#
33000	35 × 25	0.50	11.5	5.81	B41231D3339M06#
39000	25.4 × 45	0.50	12.5	6.31	B41231A3399M06#
39000	30 × 35	0.50	12.3	6.22	B41231B3399M06#
39000	35 × 30	0.50	12.6	6.38	B41231C3399M06#
47000	25.4 × 50	0.50	13.5	6.83	B41231A3479M06#
47000	30 × 40	0.50	13.4	6.78	B41231B3479M06#
47000	35 × 30	0.50	13.1	6.62	B41231C3479M06#
56000	30 × 45	0.50	14.4	7.31	B41231A3569M06#
56000	35 × 35	0.50	14.2	7.18	B41231B3569M06#
68000	35 × 40	0.50	15.3	7.76	B41231A3689M06#

Composition of ordering code

= Terminal style

0 = snap-in standard terminals (6.0 mm)

2 = snap-in 3 terminals (4.5 mm)

7 = snap-in short terminals (4.5 mm)

Technical data and ordering codes

C_R 120 Hz 20 °C μF	Case dimensions $d \times l$ mm	$\tan \delta_{\max}$ 120 Hz 20 °C	$I_{AC,\max}$ 120 Hz 60 °C A	$I_{AC,R}$ 120 Hz 85 °C A	Ordering code (composition see below)
$V_R = 16 \text{ V DC}$					
10000	22 × 25	0.50	6.57	3.32	B41231A4109M06#
12000	22 × 30	0.50	7.03	3.55	B41231A4129M06#
12000	25.4 × 25	0.50	7.70	3.89	B41231B4129M06#
15000	22 × 35	0.50	8.49	4.29	B41231A4159M06#
15000	25.4 × 30	0.50	8.81	4.45	B41231B4159M06#
15000	30 × 25	0.50	9.03	4.56	B41231C4159M06#
18000	22 × 40	0.50	9.44	4.77	B41231A4189M06#
18000	25.4 × 35	0.50	9.82	4.96	B41231B4189M06#
18000	30 × 30	0.50	10.1	5.10	B41231C4189M06#
22000	22 × 50	0.50	10.9	5.51	B41231A4229M06#
22000	25.4 × 40	0.50	10.9	5.51	B41231B4229M06#
22000	30 × 30	0.50	10.6	5.39	B41231C4229M06#
27000	25.4 × 45	0.50	12.0	6.06	B41231A4279M06#
27000	30 × 35	0.50	11.8	5.98	B41231B4279M06#
27000	35 × 25	0.50	11.5	5.80	B41231C4279M06#
33000	30 × 40	0.50	13.0	6.56	B41231A4339M06#
33000	35 × 30	0.50	12.7	6.41	B41231B4339M06#
39000	30 × 45	0.50	14.0	7.08	B41231A4399M06#
39000	35 × 35	0.50	13.8	6.96	B41231B4399M06#
47000	30 × 50	0.50	15.1	7.62	B41231A4479M06#
47000	35 × 40	0.50	14.9	7.54	B41231B4479M06#
56000	35 × 45	0.50	16.0	8.08	B41231A4569M06#
68000	35 × 50	0.50	16.9	8.53	B41231A4689M06#

Composition of ordering code

= Terminal style

0 = snap-in standard terminals (6.0 mm)

2 = snap-in 3 terminals (4.5 mm)

7 = snap-in short terminals (4.5 mm)

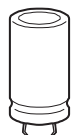
B41231
85 °C
Technical data and ordering codes

C_R 120 Hz 20 °C μF	Case dimensions $d \times l$ mm	$\tan \delta_{\max}$ 120 Hz 20 °C	$I_{AC,\max}$ 120 Hz 60 °C A	$I_{AC,R}$ 120 Hz 85 °C A	Ordering code (composition see below)
$V_R = 25 \text{ V DC}$					
5600	22 × 25	0.40	5.25	2.65	B41231A5568M06#
6800	22 × 30	0.40	6.06	3.06	B41231A5688M06#
6800	25.4 × 25	0.40	6.24	3.15	B41231B5688M06#
8200	22 × 35	0.40	6.83	3.45	B41231A5828M06#
8200	25.4 × 30	0.40	7.07	3.57	B41231B5828M06#
10000	22 × 40	0.40	7.82	3.95	B41231A5109M06#
10000	25.4 × 30	0.40	7.70	3.89	B41231B5109M06#
12000	22 × 45	0.40	8.73	4.41	B41231A5129M06#
12000	25.4 × 35	0.40	8.65	4.37	B41231B5129M06#
12000	30 × 25	0.40	7.90	3.99	B41231C5129M06#
15000	22 × 50	0.40	9.78	4.94	B41231A5159M06#
15000	25.4 × 40	0.40	9.78	4.94	B41231B5159M06#
15000	30 × 30	0.40	8.91	4.50	B41231C5159M06#
18000	25.4 × 45	0.40	10.8	5.45	B41231A5189M06#
18000	30 × 35	0.40	10.1	5.10	B41231B5189M06#
22000	30 × 35	0.40	10.6	5.38	B41231A5229M06#
22000	35 × 30	0.40	10.9	5.51	B41231B5229M06#
27000	30 × 45	0.40	12.3	6.22	B41231A5279M06#
27000	35 × 35	0.40	12.1	6.12	B41231B5279M06#
33000	30 × 50	0.40	13.5	6.82	B41231A5339M06#
33000	35 × 40	0.40	13.3	6.74	B41231B5339M06#
39000	35 × 45	0.40	14.5	7.35	B41231A5399M06#

Composition of ordering code

= Terminal style

0 = snap-in standard terminals (6.0 mm)

2 = snap-in 3 terminals (4.5 mm)

7 = snap-in short terminals (4.5 mm)

Technical data and ordering codes

C_R 120 Hz 20 °C μF	Case dimensions $d \times l$ mm	$\tan \delta_{\max}$ 120 Hz 20 °C	$I_{AC,\max}$ 120 Hz 60 °C A	$I_{AC,R}$ 120 Hz 85 °C A	Ordering code (composition see below)
$V_R = 35 \text{ V DC}$					
4700	22 × 30	0.40	6.06	3.06	B41231A7478M06#
4700	25.4 × 25	0.40	5.90	2.98	B41231B7478M06#
5600	22 × 35	0.40	6.49	3.28	B41231A7568M06#
5600	25.4 × 30	0.40	6.71	3.39	B41231B7568M06#
6800	22 × 40	0.40	7.39	3.73	B41231A7688M06#
6800	25.4 × 30	0.40	7.27	3.67	B41231B7688M06#
6800	30 × 25	0.40	7.44	3.76	B41231C7688M06#
8200	22 × 45	0.40	8.18	4.13	B41231A7828M06#
8200	25.4 × 35	0.40	8.12	4.10	B41231B7828M06#
8200	30 × 30	0.40	8.36	4.22	B41231C7828M06#
10000	22 × 50	0.40	9.27	4.68	B41231A7109M06#
10000	25.4 × 40	0.40	9.27	4.68	B41231B7109M06#
10000	30 × 30	0.40	9.07	4.58	B41231C7109M06#
12000	25.4 × 45	0.40	10.2	5.18	B41231A7129M06#
12000	30 × 35	0.40	10.1	5.11	B41231C7129M06#
12000	35 × 30	0.40	10.4	5.24	B41231D7129M06#
15000	30 × 40	0.40	11.3	5.72	B41231A7159M06#
15000	35 × 35	0.40	11.6	5.88	B41231B7159M06#
18000	30 × 45	0.40	12.4	6.28	B41231A7189M06#
18000	35 × 40	0.40	12.8	6.46	B41231B7189M06#
22000	35 × 45	0.40	14.0	7.07	B41231A7229M06#

Composition of ordering code

= Terminal style

0 = snap-in standard terminals (6.0 mm)

2 = snap-in 3 terminals (4.5 mm)

7 = snap-in short terminals (4.5 mm)

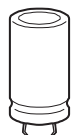
B41231
85 °C
Technical data and ordering codes

C_R 120 Hz 20 °C μF	Case dimensions $d \times l$ mm	$\tan \delta_{\max}$ 120 Hz 20 °C	$I_{AC,\max}$ 120 Hz 60 °C A	$I_{AC,R}$ 120 Hz 85 °C A	Ordering code (composition see below)
$V_R = 50 \text{ V DC}$					
3300	22 × 30	0.30	5.88	2.97	B41231A6338M06#
3300	25.4 × 25	0.30	7.58	3.06	B41231B6338M06#
4700	22 × 40	0.30	7.58	3.83	B41231A6478M06#
4700	25.4 × 35	0.30	7.88	3.98	B41231B6478M06#
4700	30 × 25	0.30	7.64	3.86	B41231C6478M06#
4700	35 × 25	0.30	8.30	4.19	B41231D6478M06#
5600	22 × 45	0.30	8.43	4.26	B41231A6568M06#
5600	25.4 × 40	0.30	8.79	4.44	B41231B6568M06#
5600	30 × 30	0.30	8.61	4.35	B41231C6568M06#
5600	35 × 25	0.30	8.79	4.44	B41231D6568M06#
6800	22 × 50	0.30	9.44	4.77	B41231A6688M06#
6800	25.4 × 45	0.30	9.42	4.76	B41231B6688M06#
6800	30 × 35	0.30	9.74	4.92	B41231C6688M06#
6800	35 × 30	0.30	9.98	5.04	B41231D6688M06#
8200	25.4 × 50	0.30	10.7	5.43	B41231A6828M06#
8200	30 × 40	0.30	10.6	5.38	B41231B6828M06#
8200	35 × 30	0.30	10.4	5.26	B41231C6828M06#
10000	30 × 45	0.30	12.0	6.07	B41231A6109M06#
10000	35 × 35	0.30	11.8	5.97	B41231B6109M06#
12000	30 × 50	0.30	13.1	6.62	B41231A6129M06#
12000	35 × 40	0.30	12.9	6.55	B41231B6129M06#
15000	35 × 45	0.30	14.2	7.20	B41231A6159M06#
18000	35 × 50	0.30	15.3	7.74	B41231A6189M06#

Composition of ordering code

= Terminal style

0 = snap-in standard terminals (6.0 mm)

2 = snap-in 3 terminals (4.5 mm)

7 = snap-in short terminals (4.5 mm)

Technical data and ordering codes

C_R 120 Hz 20 °C μF	Case dimensions $d \times l$ mm	$\tan \delta_{\max}$ 120 Hz 20 °C	$I_{AC,\max}$ 120 Hz 60 °C A	$I_{AC,R}$ 120 Hz 85 °C A	Ordering code (composition see below)
$V_R = 63 \text{ V DC}$					
1800	22 × 25	0.25	4.36	2.20	B41231A8188M06#
2200	22 × 30	0.25	4.95	2.50	B41231A8228M06#
2200	25.4 × 25	0.25	5.11	2.58	B41231B8228M06#
2700	22 × 35	0.25	5.82	2.94	B41231A8278M06#
2700	25.4 × 30	0.25	6.02	3.04	B41231B8278M06#
3300	22 × 35	0.25	6.22	3.14	B41231A8338M06#
3300	25.4 × 30	0.25	6.45	3.26	B41231B8338M06#
3300	30 × 25	0.25	6.61	3.34	B41231C8338M06#
3900	22 × 40	0.25	7.13	3.60	B41231A8398M06#
3900	25.4 × 35	0.25	7.41	3.74	B41231B8398M06#
3900	30 × 30	0.25	7.62	3.85	B41231C8398M06#
4700	22 × 50	0.25	8.30	4.19	B41231A8478M06#
4700	25.4 × 40	0.25	8.30	4.19	B41231B8478M06#
4700	30 × 35	0.25	8.12	4.10	B41231C8478M06#
4700	35 × 30	0.25	8.30	4.19	B41231D8478M06#
5600	25.4 × 45	0.25	9.21	4.65	B41231A8568M06#
5600	30 × 35	0.25	9.07	4.58	B41231B8568M06#
5600	35 × 30	0.25	9.31	4.70	B41231C8568M06#
6800	25.4 × 50	0.25	10.3	5.20	B41231A8688M06#
6800	30 × 40	0.25	10.2	5.16	B41231B8688M06#
6800	35 × 30	0.25	9.98	5.04	B41231C8688M06#
8200	30 × 45	0.25	11.1	5.62	B41231A8828M06#
8200	35 × 35	0.25	10.9	5.53	B41231B8828M06#
10000	30 × 50	0.25	12.5	6.32	B41231A8109M06#
10000	35 × 40	0.25	12.4	6.25	B41231B8109M06#
12000	35 × 45	0.25	13.5	6.83	B41231A8129M06#

Composition of ordering code

= Terminal style

0 = snap-in standard terminals (6.0 mm)

2 = snap-in 3 terminals (4.5 mm)

7 = snap-in short terminals (4.5 mm)

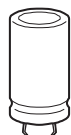
B41231
85 °C
Technical data and ordering codes

C_R 120 Hz 20 °C μF	Case dimensions $d \times l$ mm	$\tan \delta_{\max}$ 120 Hz 20 °C	$I_{AC,\max}$ 120 Hz 60 °C A	$I_{AC,R}$ 120 Hz 85 °C A	Ordering code (composition see below)
$V_R = 80 \text{ V DC}$					
1200	22 × 25	0.20	4.44	2.24	B41231A0128M06#
1500	22 × 30	0.20	5.29	2.67	B41231A0158M06#
1800	22 × 30	0.20	5.78	2.92	B41231A0188M06#
1800	25.4 × 25	0.20	5.96	3.01	B41231B0188M06#
2200	22 × 35	0.25	6.44	3.25	B41231A0228M06#
2200	25.4 × 30	0.20	6.65	3.36	B41231B0228M06#
2200	30 × 25	0.20	6.83	3.45	B41231C0228M06#
2700	22 × 40	0.20	7.50	3.79	B41231A0278M06#
2700	25.4 × 35	0.20	7.80	3.94	B41231B0278M06#
2700	30 × 30	0.20	8.02	4.05	B41231C0278M06#
3300	22 × 45	0.20	8.28	4.18	B41231A0338M06#
3300	25.4 × 40	0.20	8.63	4.36	B41231B0338M06#
3300	30 × 30	0.20	8.45	4.27	B41231C0338M06#
3900	22 × 50	0.25	9.41	4.75	B41231A0398M06#
3900	25.4 × 45	0.20	9.82	4.96	B41231B0398M06#
3900	30 × 35	0.20	9.68	4.89	B41231C0398M06#
4700	25.4 × 50	0.20	10.7	5.44	B41231A0478M06#
4700	30 × 40	0.20	10.6	5.39	B41231B0478M06#
4700	35 × 30	0.20	10.4	5.27	B41231C0478M06#
5600	30 × 45	0.20	11.7	5.91	B41231A0568M06#
5600	35 × 35	0.20	11.5	5.81	B41231B0568M06#
6800	35 × 40	0.20	10.8	5.46	B41231A0688M06#
8200	35 × 45	0.20	13.7	6.91	B41231A0828M06#

Composition of ordering code

= Terminal style

0 = snap-in standard terminals (6.0 mm)

2 = snap-in 3 terminals (4.5 mm)

7 = snap-in short terminals (4.5 mm)

Technical data and ordering codes

C_R 120 Hz 20 °C μF	Case dimensions $d \times l$ mm	$\tan \delta_{\max}$ 120 Hz 20 °C	$I_{AC,\max}$ 120 Hz 60 °C A	$I_{AC,R}$ 120 Hz 85 °C A	Ordering code (composition see below)
$V_R = 100 \text{ V DC}$					
1200	22 × 30	0.15	4.73	2.39	B41231A9128M06#
1200	25.4 × 25	0.15	4.87	2.46	B41231B9128M06#
1500	22 × 35	0.15	5.60	2.83	B41231A9158M06#
1500	25.4 × 30	0.15	5.80	2.93	B41231B9158M06#
1500	30 × 25	0.15	5.94	3.00	B41231C9158M06#
1800	22 × 40	0.15	6.45	3.26	B41231A9188M06#
1800	25.4 × 35	0.15	6.71	3.39	B41231B9188M06#
1800	30 × 30	0.15	6.91	3.49	B41231C9188M06#
2200	22 × 45	0.15	7.09	3.58	B41231A9228M06#
2200	25.4 × 40	0.15	7.41	3.74	B41231B9228M06#
2200	30 × 30	0.15	7.25	3.66	B41231C9228M06#
2700	25.4 × 45	0.15	8.57	4.33	B41231A9278M06#
2700	30 × 35	0.15	8.45	4.27	B41231B9278M06#
2700	35 × 30	0.15	8.65	4.37	B41231C9278M06#
3300	25.4 × 50	0.15	9.42	4.76	B41231A9338M06#
3300	30 × 40	0.15	9.35	4.72	B41231B9338M06#
3300	35 × 35	0.15	9.60	4.85	B41231C9338M06#
3900	30 × 45	0.15	10.6	5.36	B41231A9398M06#
3900	35 × 35	0.15	10.4	5.27	B41231B9398M06#
4700	30 × 50	0.15	11.6	5.86	B41231A9478M06#
4700	35 × 40	0.15	11.5	5.80	B41231B9478M06#
5600	35 × 45	0.15	12.5	6.34	B41231A9568M06#

Composition of ordering code

= Terminal style

0 = snap-in standard terminals (6.0 mm)

2 = snap-in 3 terminals (4.5 mm)

7 = snap-in short terminals (4.5 mm)

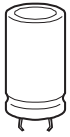

B41231

85 °C

Useful life¹⁾

depending on ambient temperature T_A under ripple current operating conditions

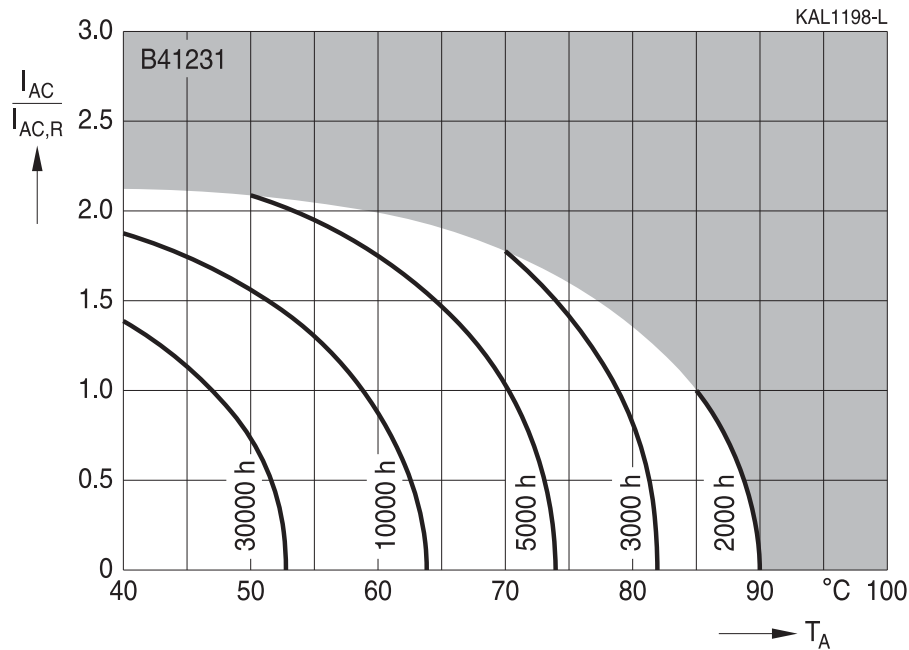

Frequency factor of permissible ripple current I_{AC} versus frequency f

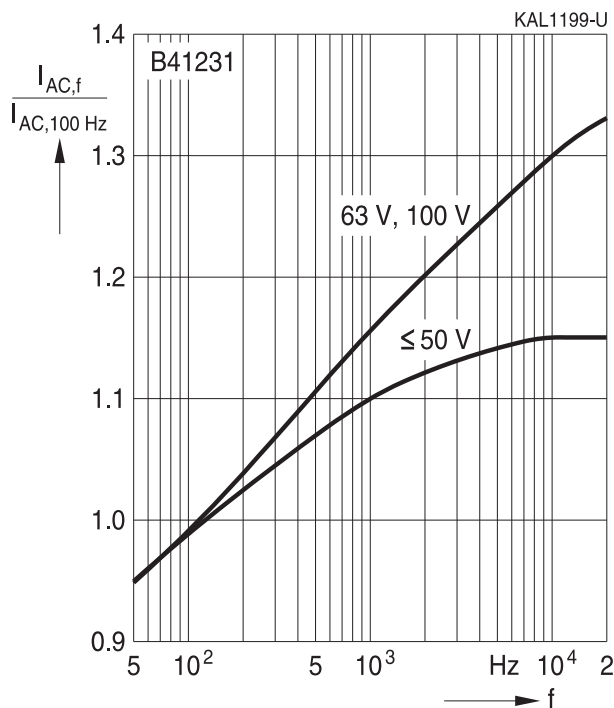

Frequency characteristics of ESR
Typical behavior

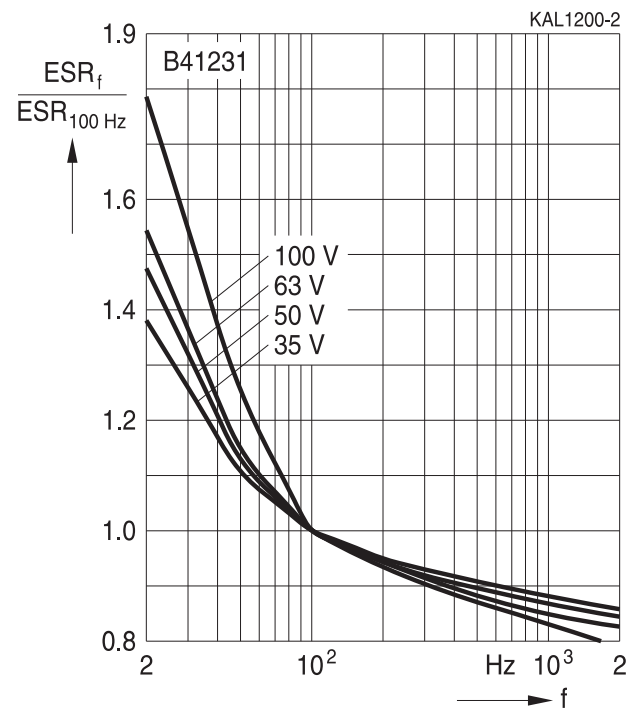

1) Refer to chapter "General technical information, 5 Useful life" on how to interpret useful life.

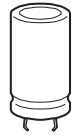

Impedance Z versus frequency f

Typical behavior at 20 °C

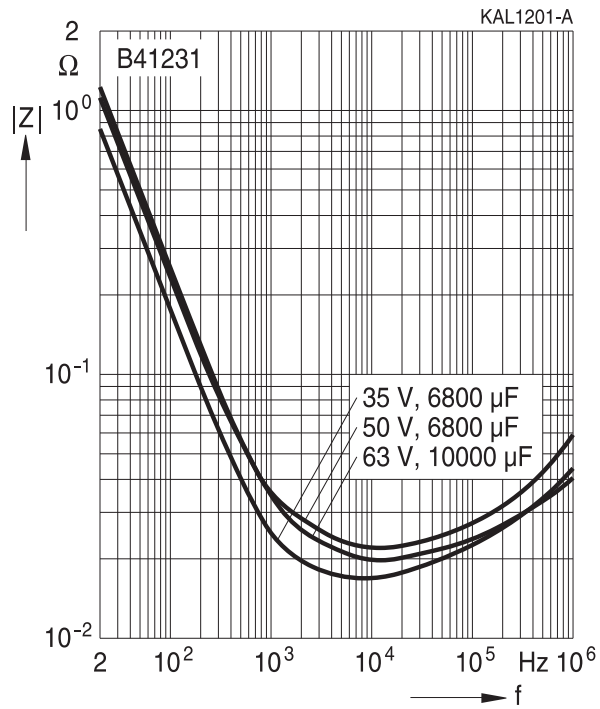

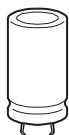

B41231

85 °C

Cautions and warnings

Personal safety

The electrolytes used have been optimized both with a view to the intended application and with regard to health and environmental compatibility. They do not contain any solvents that are detrimental to health, e.g. dimethyl formamide (DMF) or dimethyl acetamide (DMAC). Furthermore, some of the high-voltage electrolytes used are self-extinguishing.

As far as possible, we do not use any dangerous chemicals or compounds to produce operating electrolytes, although in exceptional cases, such materials must be used in order to achieve specific physical and electrical properties because no alternative materials are currently known. We do, however, restrict the amount of dangerous materials used in our products to an absolute minimum.

Materials and chemicals used in our aluminum electrolytic capacitors are continuously adapted in compliance with the TDK Electronics Corporate Environmental Policy and the latest EU regulations and guidelines such as RoHS, REACH/SVHC, GADSL, and ELV.

MDS (Material Data Sheets) are available on our website for all types listed in the data book. MDS for customer specific capacitors are available upon request.

MSDS (Material Safety Data Sheets) are available for our electrolytes upon request.

Nevertheless, the following rules should be observed when handling aluminum electrolytic capacitors: No electrolyte should come into contact with eyes or skin. If electrolyte does come into contact with the skin, wash the affected areas immediately with running water. If the eyes are affected, rinse them for 10 minutes with plenty of water. If symptoms persist, seek medical treatment. Avoid inhaling electrolyte vapor or mists. Workplaces and other affected areas should be well ventilated. Clothing that has been contaminated by electrolyte must be changed and rinsed in water.



Product safety

The table below summarizes the safety instructions that must be observed without fail. A detailed description can be found in the relevant sections of separate file chapter "General technical information".

Topic	Safety information	Reference chapter "General technical information"
Polarity	Make sure that polar capacitors are connected with the right polarity.	1 "Basic construction of aluminum electrolytic capacitors"
Reverse voltage	Voltages of opposite polarity should be prevented by connecting a diode.	3.1.6 "Reverse voltage"
Mounting position of screw-terminal capacitors	Screw terminal capacitors must not be mounted with terminals facing down unless otherwise specified.	11.1. "Mounting positions of capacitors with screw terminals"
Robustness of terminals	The following maximum tightening torques must not be exceeded when connecting screw terminals: M5: 2.5 Nm M6: 4.0 Nm	11.3 "Mounting torques"
Mounting of single-ended capacitors	The internal structure of single-ended capacitors might be damaged if excessive force is applied to the lead wires. Avoid any compressive, tensile or flexural stress. Do not move the capacitor after soldering to PC board. Do not pick up the PC board by the soldered capacitor. Do not insert the capacitor on the PC board with a hole space different to the lead space specified.	11.4 "Mounting considerations for single-ended capacitors"
Soldering	Do not exceed the specified time or temperature limits during soldering.	11.5 "Soldering"
Soldering, cleaning agents	Do not allow halogenated hydrocarbons to come into contact with aluminum electrolytic capacitors.	11.6 "Cleaning agents"
Upper category temperature	Do not exceed the upper category temperature.	7.2 "Maximum permissible operating temperature"
Passive flammability	Avoid external energy, e.g. fire.	8.1 "Passive flammability"

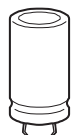

B41231

85 °C

Topic	Safety information	Reference chapter "General technical information"
Active flammability	Avoid overload of the capacitors.	8.2 "Active flammability"
Maintenance	Make periodic inspections of the capacitors. Before the inspection, make sure that the power supply is turned off and carefully discharge the capacitors. Do not apply excessive mechanical stress to the capacitor terminals when mounting.	10 "Maintenance"
Storage	Do not store capacitors at high temperatures or high humidity. Capacitors should be stored at +5 to +35 °C and a relative humidity of ≤ 75%.	7.3 "Shelf life and storage conditions"
		Reference chapter "Capacitors with screw terminals"
Breakdown strength of insulating sleeves	Do not damage the insulating sleeve, especially when ring clips are used for mounting.	"Screw terminals – accessories"

Display of ordering codes for TDK Electronics products

The ordering code for one and the same product can be represented differently in data sheets, data books, other publications, on the company website, or in order-related documents such as shipping notes, order confirmations and product labels. The varying representations of the ordering codes are due to different processes employed and do not affect the specifications of the respective products.

Detailed information can be found on the Internet under www.tdk-electronics.tdk.com/orderingcodes.



Symbols and terms

Symbol	English	German
C	Capacitance	Kapazität
C_R	Rated capacitance	Nennkapazität
C_S	Series capacitance	Serienkapazität
$C_{S,T}$	Series capacitance at temperature T	Serienkapazität bei Temperatur T
C_f	Capacitance at frequency f	Kapazität bei Frequenz f
d	Case diameter, nominal dimension	Gehäusedurchmesser, Nennmaß
d_{max}	Maximum case diameter	Maximaler Gehäusedurchmesser
ESL	Self-inductance	Eigeninduktivität
ESR	Equivalent series resistance	Ersatzserienwiderstand
ESR_f	Equivalent series resistance at frequency f	Ersatzserienwiderstand bei Frequenz f
ESR_T	Equivalent series resistance at temperature T	Ersatzserienwiderstand bei Temperatur T
f	Frequency	Frequenz
I	Current	Strom
I_{AC}	Alternating current (ripple current)	Wechselstrom
$I_{AC,RMS}$	Root-mean-square value of alternating current	Wechselstrom, Effektivwert
$I_{AC,f}$	Ripple current at frequency f	Wechselstrom bei Frequenz f
$I_{AC,max}$	Maximum permissible ripple current	Maximal zulässiger Wechselstrom
$I_{AC,R}$	Rated ripple current	Nennwechselstrom
I_{leak}	Leakage current	Reststrom
$I_{leak,op}$	Operating leakage current	Betriebsreststrom
l	Case length, nominal dimension	Gehäuselänge, Nennmaß
l_{max}	Maximum case length (without terminals and mounting stud)	Maximale Gehäuselänge (ohne Anschlüsse und Gewindebolzen)
R	Resistance	Widerstand
R_{ins}	Insulation resistance	Isolationswiderstand
R_{symm}	Balancing resistance	Symmetrierwiderstand
T	Temperature	Temperatur
ΔT	Temperature difference	Temperaturdifferenz
T_A	Ambient temperature	Umgebungstemperatur
T_C	Case temperature	Gehäusetemperatur
T_B	Capacitor base temperature	Temperatur des Gehäusebodens
t	Time	Zeit
Δt	Period	Zeitraum
t_b	Service life (operating hours)	Brauchbarkeitsdauer (Betriebszeit)

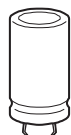

B41231

85 °C

Symbol	English	German
V	Voltage	Spannung
V_F	Forming voltage	Formierspannung
V_{op}	Operating voltage	Betriebsspannung
V_R	Rated voltage, DC voltage	Nennspannung, Gleichspannung
V_S	Surge voltage	Spitzenspannung
X_C	Capacitive reactance	Kapazitiver Blindwiderstand
X_L	Inductive reactance	Induktiver Blindwiderstand
Z	Impedance	Scheinwiderstand
Z_T	Impedance at temperature T	Scheinwiderstand bei Temperatur T
$\tan \delta$	Dissipation factor	Verlustfaktor
λ	Failure rate	Ausfallrate
ϵ_0	Absolute permittivity	Elektrische Feldkonstante
ϵ_r	Relative permittivity	Dielektrizitätszahl
ω	Angular velocity; $2 \cdot \pi \cdot f$	Kreisfrequenz; $2 \cdot \pi \cdot f$

Note

All dimensions are given in mm.

Important notes

The following applies to all products named in this publication:

1. Some parts of this publication contain **statements about the suitability of our products for certain areas of application**. These statements are based on our knowledge of typical requirements that are often placed on our products in the areas of application concerned. We nevertheless expressly point out **that such statements cannot be regarded as binding statements about the suitability of our products for a particular customer application**. As a rule, we are either unfamiliar with individual customer applications or less familiar with them than the customers themselves. For these reasons, it is always ultimately incumbent on the customer to check and decide whether a product with the properties described in the product specification is suitable for use in a particular customer application.
2. We also point out that **in individual cases, a malfunction of electronic components or failure before the end of their usual service life cannot be completely ruled out in the current state of the art, even if they are operated as specified**. In customer applications requiring a very high level of operational safety and especially in customer applications in which the malfunction or failure of an electronic component could endanger human life or health (e.g. in accident prevention or lifesaving systems), it must therefore be ensured by means of suitable design of the customer application or other action taken by the customer (e.g. installation of protective circuitry or redundancy) that no injury or damage is sustained by third parties in the event of malfunction or failure of an electronic component.
3. **The warnings, cautions and product-specific notes must be observed.**
4. In order to satisfy certain technical requirements, **some of the products described in this publication may contain substances subject to restrictions in certain jurisdictions (e.g. because they are classed as hazardous)**. Useful information on this will be found in our Material Data Sheets on the Internet (www.tdk-electronics.tdk.com/material). Should you have any more detailed questions, please contact our sales offices.
5. We constantly strive to improve our products. Consequently, **the products described in this publication may change from time to time**. The same is true of the corresponding product specifications. Please check therefore to what extent product descriptions and specifications contained in this publication are still applicable before or when you place an order. We also **reserve the right to discontinue production and delivery of products**. Consequently, we cannot guarantee that all products named in this publication will always be available. The aforementioned does not apply in the case of individual agreements deviating from the foregoing for customer-specific products.
6. Unless otherwise agreed in individual contracts, **all orders are subject to our General Terms and Conditions of Supply**.

Important notes

7. **Our manufacturing sites serving the automotive business apply the IATF 16949 standard.** The IATF certifications confirm our compliance with requirements regarding the quality management system in the automotive industry. Referring to customer requirements and customer specific requirements (“CSR”) TDK always has and will continue to have the policy of respecting individual agreements. Even if IATF 16949 may appear to support the acceptance of unilateral requirements, we hereby like to emphasize that **only requirements mutually agreed upon can and will be implemented in our Quality Management System.** For clarification purposes we like to point out that obligations from IATF 16949 shall only become legally binding if individually agreed upon.
8. The trade names EPCOS, CeraCharge, CeraDiode, CeraLink, CeraPad, CeraPlas, CSMP, CTVS, DeltaCap, DigiSiMic, ExoCore, FilterCap, FormFit, LeaXield, MiniBlue, MiniCell, MKD, MKK, MotorCap, PCC, PhaseCap, PhaseCube, PhaseMod, PhiCap, PowerHap, PQSine, PQvar, SIFERRIT, SIFI, SIKOREL, SilverCap, SIMDAD, SiMic, SIMID, SineFormer, SIOV, ThermoFuse, WindCap are **trademarks registered or pending** in Europe and in other countries. Further information will be found on the Internet at www.tdk-electronics.tdk.com/trademarks.

Release 2018-10