



Aluminum electrolytic capacitors

SMD capacitors

Series/Type: B41112

Date: November 2008

The following products presented in this data sheet are being withdrawn.

Ordering Code	Substitute Product	Date of Withdrawal	Deadline Last Orders	Last Shipments
B41112B3227M000		2011-06-24	2011-09-30	2011-12-30
B41112B2337M000		2011-06-24	2011-09-30	2011-12-30
B41112C7476M000		2011-06-24	2011-09-30	2011-12-30

© EPCOS AG 2008. Reproduction, publication and dissemination of this publication, enclosures hereto and the information contained therein without EPCOS' prior express consent is prohibited.



Ordering Code	Substitute Product	Date of Withdrawal	Deadline Last Orders	Last Shipments
B41112C7336M000		2011-06-24	2011-09-30	2011-12-30
B41112C6336M000		2011-06-24	2011-09-30	2011-12-30
B41112C6226M000		2011-06-24	2011-09-30	2011-12-30
B41112C5107M000		2011-06-24	2011-09-30	2011-12-30
B41112C4107M000		2011-06-24	2011-09-30	2011-12-30
B41112C2227M000		2011-06-24	2011-09-30	2011-12-30
B41112B9335M000		2011-06-24	2011-09-30	2011-12-30

For further information please contact your nearest EPCOS sales office, which will also support you in selecting a suitable substitute. The addresses of our worldwide sales network are presented at www.epcos.com/sales.

General-purpose grade capacitors
Applications

- General-purpose applications in the entertainment industry

Features

- Miniaturized dimensions
- RoHS compatible
- Load life of 2000 h at 85 °C
- Suitable for reflow soldering, see chapter "SMD capacitors - Mounting instructions"

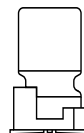
Construction

- Surface mounting device
- Minus pole marking on the case

Delivery mode

- Taped and reeled Refer to chapter "SMD capacitors - Taping and packing" for further details.

Specifications and characteristics in brief

Rated voltage V_R	4 ... 100 V DC									
Operating temperature range	-40 °C ... +85 °C									
Rated capacitance C_R (20 °C, 120 Hz)	0.1 ... 1500 μ F									
Capacitance tolerance	$\pm 20\% \triangleq M$									
Load life (85 °C, V_R)	2000 h	Requirements: $\Delta C/C \leq \pm 20\%$ of initial value (4 V: within $\pm 25\%$ of initial value) $\tan \delta \leq 2$ times initial specified limit $I_{leak} \leq$ initial specified limit								
Leakage current I_{leak} (20 °C, after 2 minutes)	$I_{leak} \leq 0.01 \mu A \cdot \left(\frac{C_R}{\mu F} \cdot \frac{V_R}{V} \right)$ or 3 μA , whichever is greater									
Low temperature stability (impedance ratio) (120 Hz)	V_R (V DC)	4	6.3	10	16	25	35	50	63	100
	$Z(-25\text{ °C})$	$< \emptyset 8$	7	4	3	2	2	2	2	2
	$Z(+20\text{ °C})$	$\geq \emptyset 8$	7	5	4	3	2	2	2	2
	$Z(-40\text{ °C})$	$< \emptyset 8$	15	8	8	4	4	3	3	3
	$Z(+20\text{ °C})$	$\geq \emptyset 8$	15	10	8	6	4	3	3	3
Shelf life	After storage for 1000 h at 85 °C, the capacitors shall meet the requirement of load life test after reforming process. After test: V_R to be applied for 30 minutes, 24 to 48 hours before measurement.									
Frequency multiplier for rated ripple current	50 Hz	120 Hz	300 Hz	1 kHz	≥ 10 kHz					
	0.70	1.00	1.17	1.36	1.50					

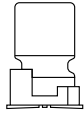
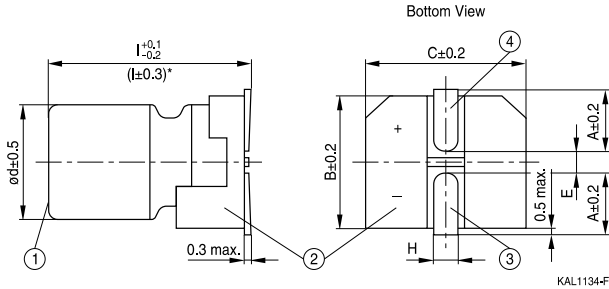

Dimensional drawings
d x l (mm)
4 x 5.4 ... 8 x 6.2:

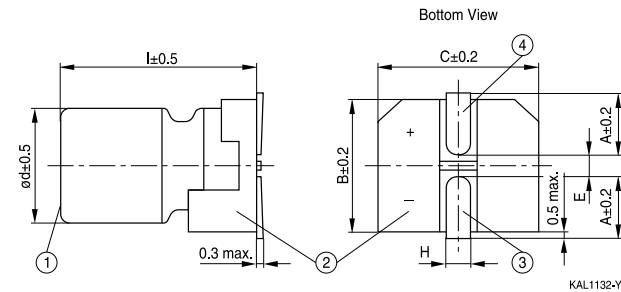
* Applies to 6.3 x 5.8 mm, 6.3 x 7.7 mm and 8 x 6.2 mm

d x l (mm)
8 x 10 ... 10 x 10:

①	Case
②	Terminal base board
③	Minus pole
④	Plus pole

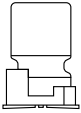
Case dimensions d x l (mm)	4 x 5.4	5 x 5.4	6.3 x 5.4	6.3 x 5.8	6.3 x 7.7	8 x 6.2	8 x 10	10 x 10
A	1.8	2.1	2.4	2.4	2.4	3.3	2.9	3.2
B	4.3	5.3	6.6	6.6	6.6	8.3	8.3	10.3
C	4.3	5.3	6.6	6.6	6.6	8.3	8.3	10.3
E	1.0	1.3	2.2	2.2	2.2	2.3	3.1	4.5
H	0.5 ... 0.8						0.8 ... 1.1	



B41112

Standard series – 85 °C

Layout recommendation

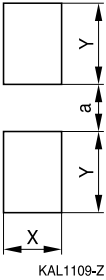

d × l (mm)	X	Y	a
4.0 × 5.4	1.6	2.6	1.0
5.0 × 5.4	1.6	3.0	1.4
6.3 × 5.4	1.6	3.5	2.1
6.3 × 5.8	1.6	3.5	2.1
6.3 × 7.7	1.6	3.5	2.1
8.0 × 6.2	2.5	4.0	2.1
8.0 × 10.0	2.5	3.5	3.0
10.0 × 10.0	2.5	4.0	4.0

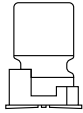

Overview of available types

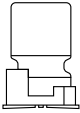
V_R (V DC)	4.0	6.3	10	16	25
	Case dimensions $d \times l$ (mm)				
C_R (μ F)					
4.7					4 × 5.4
10				4 × 5.4	4 × 5.4 5 × 5.4
22		4 × 5.4	4 × 5.4 5 × 5.4	4 × 5.4 5 × 5.4	5 × 5.4 6.3 × 5.4
33	4 × 5.4	4 × 5.4 5 × 5.4	4 × 5.4 5 × 5.4	5 × 5.4 6.3 × 5.4	5 × 5.4 6.3 × 5.4
47	4 × 5.4	4 × 5.4 5 × 5.4	5 × 5.4 6.3 × 5.4	5 × 5.4 6.3 × 5.4	6.3 × 5.4 6.3 × 5.8
56	5 × 5.4	5 × 5.4 6.3 × 5.4	5 × 5.4 6.3 × 5.4	5 × 5.4 6.3 × 5.4	6.3 × 7.7
100	5 × 5.4	5 × 5.4 6.3 × 5.4	5 × 5.4 6.3 × 5.4 6.3 × 5.8	6.3 × 5.4 6.3 × 5.8 8 × 6.2	6.3 × 7.7 8 × 6.2 8 × 10
150	6.3 × 5.4	6.3 × 5.4	6.3 × 7.7	6.3 × 7.7	8 × 10
220	6.3 × 5.4 6.3 × 5.8	6.3 × 5.4 6.3 × 5.8 8 × 6.2	6.3 × 7.7 8 × 6.2	6.3 × 7.7 8 × 10	8 × 10 10 × 10
330	6.3 × 5.4 6.3 × 7.7	6.3 × 7.7 8 × 6.2	8 × 10	8 × 10 10 × 10	8 × 10 10 × 10
470	6.3 × 7.7	8 × 10	8 × 10 10 × 10	8 × 10 10 × 10	10 × 10
680	8 × 10	8 × 10	10 × 10	10 × 10	
1000	8 × 10	8 × 10 10 × 10	10 × 10		
1500	10 × 10	10 × 10			

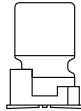

B41112
Standard series – 85 °C

V_R (V DC)	35	50	63	100
	Case dimensions $d \times l$ (mm)			
C_R (μ F)				
0.10		4 × 5.4	4 × 5.4	
0.22		4 × 5.4	4 × 5.4	
0.33		4 × 5.4	4 × 5.4	
0.47		4 × 5.4	4 × 5.4	
1.0		4 × 5.4	4 × 5.4	
2.2		4 × 5.4	4 × 5.4	
3.3		4 × 5.4	4 × 5.4	6.3 × 7.7 8 × 6.2
4.7	4 × 5.4	4 × 5.4 5 × 5.4	4 × 5.4	6.3 × 7.7 8 × 10
10	4 × 5.4 5 × 5.4	5 × 5.4 6.3 × 5.4	6.3 × 5.4 6.3 × 5.8	6.3 × 7.7 8 × 10
22	5 × 5.4 6.3 × 5.4	6.3 × 5.4 6.3 × 5.8 8 × 6.2	6.3 × 7.7 8 × 10	8 × 10 10 × 10
33	6.3 × 5.4 6.3 × 5.8 8 × 6.2	6.3 × 7.7 8 × 6.2 8 × 10	8 × 10	10 × 10
47	6.3 × 5.4 6.3 × 7.7 8 × 6.2	6.3 × 7.7 8 × 10 10 × 10	8 × 10	
56	6.3 × 7.7	8 × 10	8 × 10	
100	6.3 × 7.7 8 × 10 10 × 10	8 × 10 10 × 10	10 × 10	
150	8 × 10	10 × 10		
220	8 × 10 10 × 10	10 × 10		
330	10 × 10			

Other voltage and capacitance ratings are available upon request.

Technical data and ordering codes

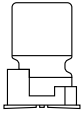
V_R	C_R 120 Hz, 20 °C μF	Case dimensions $d \times l$ mm	$\tan \delta_{\max}$ 120 Hz, 20 °C	$I_{AC,R}$ 120 Hz, 85 °C mA	Ordering code
4	33	4 × 5.4	0.35	28	B41112A1336M000
	47	4 × 5.4	0.35	34	B41112A1476M000
	56	5 × 5.4	0.35	45	B41112A1566M000
	100	5 × 5.4	0.35	61	B41112A1107M000
	150	6.3 × 5.4	0.35	79	B41112A1157M000
	220	6.3 × 5.4	0.35	96	B41112A1227M000
	220	6.3 × 5.8	0.35	99	B41112B1227M000
	330	6.3 × 5.4	0.50	98	B41112A1337M000
	330	6.3 × 7.7	0.35	140	B41112B1337M000
	470	6.3 × 7.7	0.35	200	B41112A1477M000
	680	8 × 10	0.35	284	B41112A1687M000
	1000	8 × 10	0.35	344	B41112A1108M000
	1500	10 × 10	0.35	347	B41112A1158M000
	6.3	22	4 × 5.4	0.26	29
33		4 × 5.4	0.35	34	B41112A2336M000
33		5 × 5.4	0.26	37	B41112B2336M000
47		4 × 5.4	0.35	40	B41112A2476M000
47		5 × 5.4	0.26	46	B41112B2476M000
56		5 × 5.4	0.35	46	B41112A2566M000
56		6.3 × 5.4	0.26	52	B41112B2566M000
100		5 × 5.4	0.35	47	B41112A2107M000
100		6.3 × 5.4	0.26	71	B41112B2107M000
150		6.3 × 5.4	0.35	72	B41112A2157M000
220		6.3 × 5.4	0.35	86	B41112A2227M000
220		6.3 × 5.8	0.35	89	B41112B2227M000
220		8 × 6.2	0.35	103	B41112C2227M000
330		6.3 × 7.7	0.26	188	B41112A2337M000
330		8 × 6.2	0.35	300	B41112B2337M000
470		8 × 10	0.35	380	B41112A2477M000
680		8 × 10	0.35	457	B41112A2687M000
1000		8 × 10	0.35	500	B41112A2108M000
1000		10 × 10	0.35	700	B41112B2108M000
1500		10 × 10	0.35	750	B41112A2158M000

B41112
Standard series – 85 °C
Technical data and ordering codes

V_R	C_R 120 Hz, 20 °C μF	Case dimensions $d \times l$ mm	$\tan \delta_{\text{max}}$ 120 Hz, 20 °C	$I_{\text{AC,R}}$ 120 Hz, 85 °C mA	Ordering code
10	22	4 × 5.4	0.30	30	B41112A3226M000
	22	5 × 5.4	0.20	33	B41112B3226M000
	33	4 × 5.4	0.30	34	B41112A3336M000
	33	5 × 5.4	0.20	43	B41112B3336M000
	47	5 × 5.4	0.30	47	B41112A3476M000
	47	6.3 × 5.4	0.26	52	B41112B3476M000
	56	5 × 5.4	0.30	50	B41112A3566M000
	56	6.3 × 5.4	0.26	57	B41112B3566M000
	100	5 × 5.4	0.30	54	B41112A3107M000
	100	6.3 × 5.4	0.26	76	B41112B3107M000
	100	6.3 × 5.8	0.26	78	B41112C3107M000
	150	6.3 × 7.7	0.26	142	B41112A3157M000
	220	6.3 × 7.7	0.20	173	B41112A3227M000
	220	8 × 6.2	0.26	250	B41112B3227M000
	330	8 × 10	0.26	390	B41112A3337M000
	470	8 × 10	0.26	390	B41112A3477M000
	470	10 × 10	0.26	400	B41112B3477M000
680	10 × 10	0.26	481	B41112A3687M000	
1000	10 × 10	0.26	580	B41112A3108M000	
16	10	4 × 5.4	0.16	28	B41112A4106M000
	22	4 × 5.4	0.26	30	B41112A4226M000
	22	5 × 5.4	0.16	39	B41112B4226M000
	33	5 × 5.4	0.26	44	B41112A4336M000
	33	6.3 × 5.4	0.16	49	B41112B4336M000
	47	5 × 5.4	0.26	52	B41112A4476M000
	47	6.3 × 5.4	0.16	70	B41112B4476M000
	56	5 × 5.4	0.26	57	B41112A4566M000
	56	6.3 × 5.4	0.20	63	B41112B4566M000
	100	6.3 × 5.4	0.26	86	B41112A4107M000
	100	6.3 × 5.8	0.26	89	B41112B4107M000
	100	8 × 6.2	0.20	200	B41112C4107M000
	150	6.3 × 7.7	0.26	135	B41112A4157M000
	220	6.3 × 7.7	0.26	162	B41112B4227M000
	220	8 × 10	0.20	280	B41112A4227M000
	330	8 × 10	0.20	320	B41112A4337M000
	330	10 × 10	0.20	380	B41112B4337M000
	470	8 × 10	0.20	350	B41112A4477M000
	470	10 × 10	0.20	420	B41112B4477M000
	680	10 × 10	0.20	505	B41112A4687M000

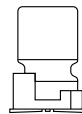
Technical data and ordering codes

V_R	C_R 120 Hz, 20 °C μF	Case dimensions $d \times l$ mm	$\tan \delta_{\text{max}}$ 120 Hz, 20 °C	$I_{\text{AC,R}}$ 120 Hz, 85 °C mA	Ordering code
25	4.7	4 × 5.4	0.14	22	B41112A5475M000
	10	4 × 5.4	0.20	24	B41112A5106M000
	10	5 × 5.4	0.14	28	B41112B5106M000
	22	5 × 5.4	0.20	38	B41112A5226M000
	22	6.3 × 5.4	0.14	55	B41112B5226M000
	33	5 × 5.4	0.20	46	B41112A5336M000
	33	6.3 × 5.4	0.14	65	B41112B5336M000
	47	6.3 × 5.4	0.20	70	B41112A5476M000
	47	6.3 × 5.8	0.20	72	B41112B5476M000
	56	6.3 × 7.7	0.20	107	B41112A5566M000
	100	6.3 × 7.7	0.14	143	B41112B5107M000
	100	8 × 6.2	0.16	145	B41112C5107M000
	100	8 × 10	0.16	180	B41112A5107M000
	150	8 × 10	0.16	192	B41112A5157M000
	220	8 × 10	0.16	232	B41112A5227M000
	220	10 × 10	0.16	310	B41112B5227M000
	330	8 × 10	0.16	284	B41112A5337M000
330	10 × 10	0.16	340	B41112B5337M000	
470	10 × 10	0.16	393	B41112A5477M000	
35	4.7	4 × 5.4	0.12	22	B41112A7475M000
	10	4 × 5.4	0.16	24	B41112A7106M000
	10	5 × 5.4	0.12	30	B41112B7106M000
	22	5 × 5.4	0.16	39	B41112A7226M000
	22	6.3 × 5.4	0.12	60	B41112B7226M000
	33	6.3 × 5.4	0.16	60	B41112A7336M000
	33	6.3 × 5.8	0.16	61	B41112B7336M000
	33	8 × 6.2	0.14	130	B41112C7336M000
	47	6.3 × 5.4	0.16	70	B41112A7476M000
	47	6.3 × 7.7	0.16	77	B41112B7476M000
	47	8 × 6.2	0.14	165	B41112C7476M000
	56	6.3 × 7.7	0.16	98	B41112A7566M000
	100	6.3 × 7.7	0.16	132	B41112C7107M000
	100	8 × 10	0.14	175	B41112A7107M000
	100	10 × 10	0.14	210	B41112B7107M000
	150	8 × 10	0.14	214	B41112A7157M000
	220	8 × 10	0.14	246	B41112A7227M000
	220	10 × 10	0.14	310	B41112B7227M000
	330	10 × 10	0.14	350	B41112A7337M000

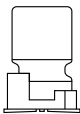
B41112
Standard series – 85 °C
Technical data and ordering codes

V_R	C_R 120 Hz, 20 °C μF	Case dimensions $d \times l$ mm	$\tan \delta_{\text{max}}$ 120 Hz, 20 °C	$I_{\text{AC,R}}$ 120 Hz, 85 °C mA	Ordering code
50	0.1	4 × 5.4	0.12	1	B41112A6104M000
	0.22	4 × 5.4	0.12	2	B41112A6224M000
	0.33	4 × 5.4	0.12	3	B41112A6334M000
	0.47	4 × 5.4	0.12	5	B41112A6474M000
	1.0	4 × 5.4	0.12	10	B41112A6105M000
	2.2	4 × 5.4	0.12	16	B41112A6225M000
	3.3	4 × 5.4	0.12	17	B41112A6335M000
	4.7	4 × 5.4	0.14	18	B41112A6475M000
	4.7	5 × 5.4	0.12	23	B41112B6475M000
	10.0	5 × 5.4	0.14	30	B41112A6106M000
	10.0	6.3 × 5.4	0.12	35	B41112B6106M000
	22	6.3 × 5.4	0.14	43	B41112A6226M000
	22	6.3 × 5.8	0.14	44	B41112B6226M000
	22	8 × 6.2	0.12	120	B41112C6226M000
	33	6.3 × 7.7	0.14	94	B41112B6336M000
	33	8 × 6.2	0.12	95	B41112C6336M000
	33	8 × 10	0.12	110	B41112A6336M000
	47	6.3 × 7.7	0.14	105	B41112C6476M000
	47	8 × 10	0.12	132	B41112A6476M000
	47	10 × 10	0.12	146	B41112B6476M000
	56	8 × 10	0.12	150	B41112A6566M000
	100	8 × 10	0.12	200	B41112A6107M000
100	10 × 10	0.12	250	B41112B6107M000	
150	10 × 10	0.12	247	B41112A6157M000	
220	10 × 10	0.12	300	B41112A6227M000	

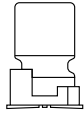
Technical data and ordering codes

V_R	C_R 120 Hz, 20 °C μF	Case dimensions $d \times l$ mm	$\tan \delta_{\max}$ 120 Hz, 20 °C	$I_{AC,R}$ 120 Hz, 85 °C mA	Ordering code
63	0.1	4 × 5.4	0.18	1	B41112A8104M000
	0.22	4 × 5.4	0.18	2.3	B41112A8224M000
	0.33	4 × 5.4	0.18	3.5	B41112A8334M000
	0.47	4 × 5.4	0.18	5	B41112A8474M000
	1.0	4 × 5.4	0.18	10	B41112A8105M000
	2.2	4 × 5.4	0.18	15	B41112A8225M000
	3.3	4 × 5.4	0.18	20	B41112A8335M000
	4.7	4 × 5.4	0.18	23	B41112A8475M000
	10	6.3 × 5.4	0.18	34	B41112A8106M000
	10	6.3 × 5.8	0.18	35	B41112B8106M000
	22	6.3 × 7.7	0.18	70	B41112B8226M000
	22	8 × 10	0.18	78	B41112A8226M000
	33	8 × 10	0.18	160	B41112A8336M000
	47	8 × 10	0.18	170	B41112A8476M000
56	8 × 10	0.18	230	B41112A8566M000	
100	10 × 10	0.18	280	B41112A8107M000	
100	3.3	6.3 × 7.7	0.18	44	B41112A9335M000
	3.3	8 × 6.2	0.18	50	B41112B9335M000
	4.7	6.3 × 7.7	0.18	62	B41112A9475M000
	4.7	8 × 10	0.18	80	B41112B9475M000
	10	6.3 × 7.7	0.18	66	B41112B9106M000
	10	8 × 10	0.18	85	B41112A9106M000
	22	8 × 10	0.18	90	B41112A9226M000
	22	10 × 10	0.18	120	B41112B9226M000
	33	10 × 10	0.18	190	B41112A9336M000

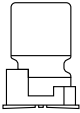

B41112

Standard series – 85 °C

Mounting instructions

Soldering

Recommended conditions

For reflow, use thermal conduction systems such as infrared radiation (IR) or hot blast. Vapor heat transfer systems (VPS) are not recommended.

- Observe proper soldering conditions (temperature, time, etc.).
- Do not exceed the specified limits.
- Temperature measuring method: Measure temperature in assuming quantitative production, by sticking the thermo-couple to the capacitor upper part with epoxy adhesives.
- Consult us for additional reflow restrictions.

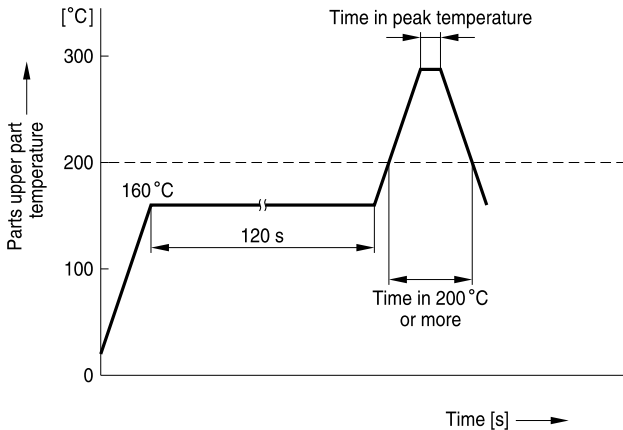

KAL1107-I

Lead-free reflow

d (mm)	4 ... 6.3	8 ... 10
Peak temperature	250 °C	235 °C
Time in peak temperature	5 s	5 s
Time in 200 °C or more	60 s	60 s
Time of reflow	1 time	1 time

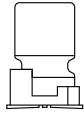
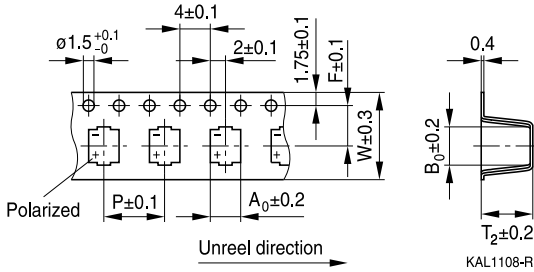
Taping and packing
Taping of SMD capacitors

Case dimensions $d \times l$ (mm)	4 × 5.4	4 × 5.8	5 × 5.4	5 × 5.8	6.3 × 5.4
W	12.0	12.0	12.0	12.0	16.0
P	8.0	8.0	12.0	12.0	12.0
F	5.5	5.5	5.5	5.5	7.5
A_0	5.0	5.0	6.0	6.0	7.0
B_0	5.0	5.0	6.0	6.0	7.0
T_2	5.8	6.3	5.8	6.3	5.8

Case dimensions $d \times l$ (mm)	6.3 × 5.8	6.3 × 7.7	8 × 6.2	8 × 10	10 × 10
W	16.0	16.0	16.0	24.0	24.0
P	12.0	12.0	12.0	16.0	16.0
F	7.5	7.5	7.5	11.5	11.5
A_0	7.0	7.0	8.7	8.7	10.7
B_0	7.0	7.0	8.7	8.7	10.7
T_2	6.3	8.2	6.8	11.0	11.0

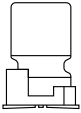

B41112

Standard series – 85 °C

Reel packing

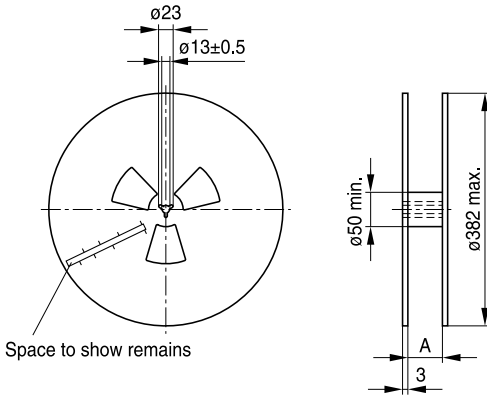

KAL1110-3

Capacitor dimensions d × l (mm)	Quantity per reel pcs.
4 × l	2000 pcs.
5 × l, 6.3 × l, 8 × 6.2	1000 pcs.
8 × 10, 10 × l	500 pcs.

d × l (mm)	4 × l, 5 × l	6.3 × l, 8 × 6.2	8 × 10, 10 × l
A	14	18	26

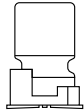

Cautions and warnings

General

- 1 Aluminum electrolytic capacitors have a bi-polar structure. This is marked on the body of the capacitor. A capacitor must not be mounted with reversed polarity. The application of an AC or reverse voltage may cause a short circuit or damage the capacitor. Bi-polar capacitors must not be used in AC applications, where the polarity may be reversed in the circuits or is unknown.
- 2 The DC voltage applied to the capacitor terminal must not exceed its rated operating voltage, as this will result in a rapid increase of the leakage current and may damage the capacitor. It is recommended to operate the capacitor at 70 – 80% of its rated voltage to optimize its service life.
- 3 The ripple current applied to the capacitor must be within the permitted range. An excessive ripple current leads to impaired electrical properties and may damage the capacitor. Note that the sum of the peak values of the ripple voltage and the DC operating voltage must not exceed the rated DC voltage.
- 4 Capacitors must be used within their permitted range of operating temperature. Operation at room temperature optimizes their service life.
- 5 Capacitors with case diameter ≥ 8 mm are equipped with a safety vent. In capacitors fitted with a lead or soldering lug, the safety vent is usually located at the base of the case. It needs sufficient space around it to operate optimally. The following dimensions are recommended: for case diameter $d = 8$ to 16 mm, more than 2 mm; for $d = 18$ to 35 mm, more than 3 mm; and for $d = 42$ mm or more, more than 5 mm.
- 6 Capacitors should not be mounted with the safety vent face down on the board. Do not locate any wire or copper trace near the safety vent. Do not reverse the voltage, as this may result in excess pressure and the leakage of electrolyte.
- 7 Gas is released through the safety vent when the pressure inside the capacitor is too high. A gaseous liquid around the safety vent does not indicate a leakage of electrolyte.
- 8 The capacitor should be stored under conditions of normal temperature and in a non-acid, non-alkali environment of normal humidity. Exposure to high temperatures, for example under direct sunlight, will reduce its operating life. If the capacitor is stored in an environment containing acids or alkalis, the solderability of the leads may be affected.
- 9 containing acids or alkalis, the solderability of the leads may be affected. The leakage current of an aluminum electrolytic capacitor may increase after a long period of storage. After such storage, the capacitor must be aged by applying the rated operating voltage for 6 – 8 hours before use.
- 10 Manual soldering:
 - a Soldering must be performed within the specified conditions.
Bit temperature: 350 °C; application time of soldering iron: 3 seconds.
 - b Ensure that the soldering iron does not touch any part of the capacitor body.

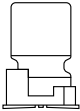

B41112

Standard series – 85 °C

- 11 Do not apply excessive force to the leads and terminals. Do not move the capacitor after soldering it onto the PC board and do not carry the PC board by gripping the capacitor. Observe the following rules to prevent undue stress to the capacitor:
 - a Do not tilt or bend the capacitor after soldering.
 - b Ensure that the terminal spacing matches the corresponding hole spacing on the PC board.
- 12 The aluminum case is not insulated from the cathode. Do not place a conductor under the aluminum capacitors on the PC board as this may cause a short circuit. The case and top of capacitors used in switched mode power supplies have a high-voltage-resistant heat shrink sleeve to ensure safe usage.
- 13 The leads of capacitors with a case diameter exceeding 14 mm cannot be used for fixing.

Important notes

The following applies to all products named in this publication:

1. Some parts of this publication contain **statements about the suitability of our products for certain areas of application**. These statements are based on our knowledge of typical requirements that are often placed on our products in the areas of application concerned. We nevertheless expressly point out **that such statements cannot be regarded as binding statements about the suitability of our products for a particular customer application**. As a rule, EPCOS is either unfamiliar with individual customer applications or less familiar with them than the customers themselves. For these reasons, it is always ultimately incumbent on the customer to check and decide whether an EPCOS product with the properties described in the product specification is suitable for use in a particular customer application.
2. We also point out that **in individual cases, a malfunction of electronic components or failure before the end of their usual service life cannot be completely ruled out in the current state of the art, even if they are operated as specified**. In customer applications requiring a very high level of operational safety and especially in customer applications in which the malfunction or failure of an electronic component could endanger human life or health (e.g. in accident prevention or lifesaving systems), it must therefore be ensured by means of suitable design of the customer application or other action taken by the customer (e.g. installation of protective circuitry or redundancy) that no injury or damage is sustained by third parties in the event of malfunction or failure of an electronic component.
3. **The warnings, cautions and product-specific notes must be observed.**
4. In order to satisfy certain technical requirements, **some of the products described in this publication may contain substances subject to restrictions in certain jurisdictions (e.g. because they are classed as hazardous)**. Useful information on this will be found in our Material Data Sheets on the Internet (www.epcos.com/material). Should you have any more detailed questions, please contact our sales offices.
5. We constantly strive to improve our products. Consequently, **the products described in this publication may change from time to time**. The same is true of the corresponding product specifications. Please check therefore to what extent product descriptions and specifications contained in this publication are still applicable before or when you place an order. We also **reserve the right to discontinue production and delivery of products**. Consequently, we cannot guarantee that all products named in this publication will always be available. The aforementioned does not apply in the case of individual agreements deviating from the foregoing for customer-specific products.
6. Unless otherwise agreed in individual contracts, **all orders are subject to the current version of the "General Terms of Delivery for Products and Services in the Electrical Industry" published by the German Electrical and Electronics Industry Association (ZVEI)**.
7. The trade names EPCOS, BAOKE, Alu-X, CeraDiode, CSSP, CTVS, DSSP, MiniBlue, MKK, MLSC, MotorCap, PCC, PhaseCap, PhaseMod, SIFERRIT, SIFI, SIKOREL, SilverCap, SIMDAD, SIMID, SineFormer, SIOV, SIP5D, SIP5K, ThermoFuse, WindCap are **trademarks registered or pending** in Europe and in other countries. Further information will be found on the Internet at www.epcos.com/trademarks.