

**GP grade**

**Standard type with small dimensions**

**Construction**

- Charge-discharge proof, polar
- Aluminum case with insulating sleeve
- Negative pole connected to case
- Axial leads, welded to ensure perfect electrical contact

**Features**

- Standard type with small dimensions
- Operation at temperatures up to 105 °C<sup>1)</sup>
- Good electrical characteristics
- High ripple current capability

**Applications**

- For general-purpose applications in entertainment electronics
- Semi-professional to professional application range
- For filtering, coupling and pulse circuits

**Tape packaging**

Capacitors with  $d \leq 16$  mm are also available on tape.

Refer to [page 420](#) for information on tapes and examples on how to order them.

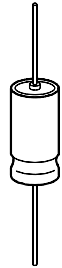

KAL0277-Z

**Specifications and characteristics in brief**

Rated voltage $U_R$	6,3 to 100 V-	
Surge voltage $U_S$	$1,15 \cdot U_R$	
Rated capacitance $C_R$	4,7 to 10 000 $\mu$ F	
Capacitance tolerance	- 10/+ 50 % $\cong$ T	
Useful life	$d \leq 10$ mm	$d \geq 12$ mm
40 °C, $U_R$	> 200 000 h ( $I_{-R,85^\circ C}$ )	> 200 000 h ( $1,4 \cdot I_{-R,85^\circ C}$ )
85 °C, $U_R$ ; $I_{-max}$	> 3 000 h	> 4 000 h
Failure percentage	$\leq 1$ % (during useful life)	
Failure rate (1 fit = $1 \cdot 10^{-9}$ /h)	$d \leq 10$ mm: $\leq 100$ fit $d \geq 12$ mm: $\leq 40$ fit	
Voltage endurance test	2 000 h, 85 °C (at $U_R$ )	
Leakage current $I_{lka}$ (5 min, 20 °C)	$I_{lka} \leq 0,3 \mu A \cdot \left( \frac{C_R}{\mu F} \cdot \frac{U_R}{V} \right)^{0,7} + 4 \mu A$	

1) Operation at 105 °C and 0,6  $I_{-max,85^\circ C}$  permissible for a total of 500 h.

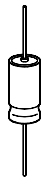

**Specifications and characteristics in brief**

Self-inductance $L_{ESL}$	$d$ (mm)	6,5	8,5	10	12	14	16	18	21	25
	$l$ (mm)	15,5	15,5	25	30	30	30	39,5	40	40
	$L_{ESL}$ approx. (nH)	14	17	35	37	38	45	57	30	34
IEC climatic category	in accordance with IEC 68-1 40/085/56 (−40 °C/+85 °C, 56 days damp heat test)									
Detail specification	similar to CECC 30 301-044									
Sectional specification	IEC 384-4									
Vibration resistance	in accordance with IEC 68-2-6, test Fc: displacement amplitude 0,35 mm, frequency range 10 to 55 Hz, acceleration max. 5 g, duration 3 × 2 h									

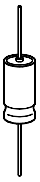

**B 41 010**  
**B 41 283**

**Dimensional drawing**

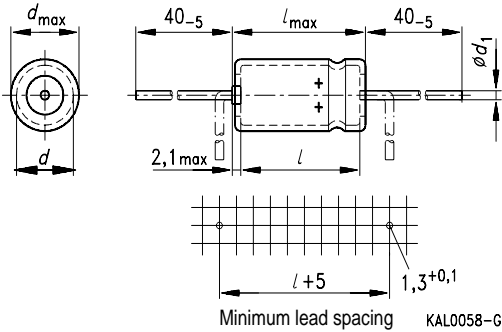

Type	Dimensions (mm)		Lead wire diameter $d_1$	Approximate weight (g)
	$d \times l$	$d_{\max} \times l_{\max}$		
B 41 283	6,5 × 15,5	7 × 17	0,6	1,1
	8,5 × 15,5	9 × 17		1,8
	10 × 25	10,5 × 26,5		3,2
B 41 010	12 × 30	12,5 × 32	0,8	5,4
	14 × 30	14,5 × 32		7,5
	16 × 30	16,5 × 32		9,3
	18 × 39,5	18,5 × 40,3		14
	21 × 40	21,5 × 41,5		18
	25 × 40	25,5 × 41,5		26

**Packing units**

Case dimensions $d \times l$ (mm)	Bulk PU (pcs.)	Reel packing PU (pcs./reel)
6,5 × 15,5	2000	1300
8,5 × 15,5	1500	1000
10 × 25	900	600
12 × 30	600	450
14 × 30	400	350
16 × 30	350	250
18 × 39,5	250	—
21 × 40	200	—
25 × 40	150	—

Not for new design. For new design see types B 41 682, [page 365](#)

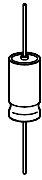

**Overview of available types**

$U_R$ (V-)	6,3	10	16	25	40	63	100
$C_R$ ( $\mu$ F)	Case dimensions $d \times l$ (mm)						
4,7							6,5 × 15,5
10						6,5 × 15,5	8,5 × 15,5
22					6,5 × 15,5	8,5 × 15,5	8,5 × 15,5
47				6,5 × 15,5	8,5 × 15,5	8,5 × 15,5	10 × 25
100		6,5 × 15,5	8,5 × 15,5	8,5 × 15,5	10 × 25	10 × 25	12 × 30
220		8,5 × 15,5	8,5 × 15,5	10 × 25	10 × 25	12 × 30	16 × 30
470	8,5 × 15,5	10 × 25	10 × 25	12 × 30	12 × 30	16 × 30	21 × 40
1 000	10 × 25	12 × 30	12 × 30	14 × 30	16 × 30	21 × 40	
2 200	12 × 30	14 × 30	16 × 30	18 × 39,5	21 × 40		
4 700	16 × 30	18 × 39,5	21 × 40	25 × 40			
10 000		25 × 40					

The above capacitance and voltage ratings are available in different cases upon request. Other voltage and capacitance ratings are also available upon request.

Not for new design. For new design see type B 41 682, [page 365](#)

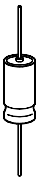

**B 41 010**  
**B 41 283**

**Technical data and ordering codes**

$U_R$	$C_R$	Case dimensions $d \times l$ mm	$R_{ESR, typ}$ 100 Hz 20 °C $\Omega$	$R_{ESR, max}$ 100 Hz 20 °C $\Omega$	$Z_{max}$ 10 kHz 20 °C $\Omega$	$I_{-max}$ 100 Hz 40 °C A	$I_{-R}$ 100 Hz 85 °C A	Ordering code <sup>1)</sup>  Short code
<b>B41010-</b> ( $d \geq 12$ mm), <b>B41283-</b> ( $d \leq 10$ mm)								
6,3	470	8,5 × 15,5	0,44	0,75	0,46	0,73	0,25	-D2477-T90
	1 000	10 × 25	0,24	0,35	0,22	1,2	0,42	-B2108-T90
	2 200	12 × 30	0,12	0,19	0,10	2,1	0,71	-B2228-T
	4 700	16 × 30	0,08	0,11	0,05	3,2	1,1	-E2478-T
10	100	6,5 × 15,5	1,5	3,5	1,7	0,35	0,12	-C3107-T90
	220	8,5 × 15,5	0,65	1,4	0,79	0,61	0,21	-D3227-T90
	470	10 × 25	0,32	0,68	0,37	1,0	0,36	-B3477-T90
	1 000	12 × 30	0,18	0,32	0,16	1,7	0,57	-A3108-T
	2 200	14 × 30	0,19	0,18	0,08	2,3	0,81	-C3228-T
	4 700	18 × 39,5	0,06	0,10	0,05	4,1	1,4	-C3478-T
	10 000	25 × 40	0,05	0,07	0,05	5,5	1,9	-C3109-T
16	100	8,5 × 15,5	1,3	2,8	1,4	0,41	0,14	-C4107-T90
	220	8,5 × 15,5	0,58	1,3	0,65	0,61	0,21	-C4227-T90
	470	10 × 25	0,27	0,60	0,30	1,1	0,39	-B4477-T90
	1 000	12 × 30	0,15	0,28	0,13	1,8	0,63	-B4108-T
	2 200	16 × 30	0,09	0,16	0,06	2,7	0,93	-E4228-T
	4 700	21 × 40	0,06	0,09	0,05	4,4	1,5	-C4478-T
25	47	6,5 × 15,5	2,4	5,3	2,1	0,26	0,09	-C5476-T90
	100	8,5 × 15,5	1,0	2,5	1,0	0,46	0,16	-C5107-T90
	220	10 × 25	0,44	1,1	0,45	0,81	0,28	-C5227-T90
	470	12 × 30	0,21	0,53	0,19	1,5	0,53	-B5477-T
	1 000	14 × 30	0,12	0,25	0,09	2,1	0,74	-C5108-T
	2 200	18 × 39,5	0,07	0,14	0,05	3,8	1,3	-C5228-T
	4 700	25 × 40	0,05	0,09	0,05	5,2	1,8	-C5478-T

Not for new design. For new design see type B 41 682, [page 365](#)

1) To obtain the required ordering code, prefix the type number to the short code. E. g.: B41283-D2477-T90  
B41283-... ( $d \leq 10$  mm)  
B41010-... ( $d \geq 12$  mm)



**Technical data and ordering codes**

$U_R$	$C_R$	Case dimensions $d \times l$ mm	$R_{ESR, typ}$ 100 Hz 20 °C $\Omega$	$R_{ESR, max}$ 100 Hz 20 °C $\Omega$	$Z_{max}$ 10 kHz 20 °C $\Omega$	$I_{-max}$ 100 Hz 40 °C A	$I_{-R}$ 100 Hz 85 °C A	Ordering code <sup>1)</sup>  Short code
<b>B41010-</b> ( $d \geq 12$ mm), <b>B41283-</b> ( $d \leq 10$ mm)								
40	22	6,5 × 15,5	4,0	8,0	3,6	0,20	0,07	-C7226-T90
	47	8,5 × 15,5	1,5	3,8	1,7	0,38	0,13	-E7476-T90
	100	10 × 25	0,70	1,8	0,80	0,64	0,22	-C7107-T90
	220	10 × 25	0,36	0,80	0,36	0,96	0,33	-B7227-T90
	470	12 × 30	0,18	0,38	0,15	1,7	0,57	-B7477-T
	1 000	16 × 30	0,10	0,18	0,08	2,6	0,88	-E7108-T
	2 200	21 × 40	0,07	0,11	0,05	4,1	1,4	-C7228-T
	63	10	6,5 × 15,5	5,0	13	6,0	0,17	0,06
22		8,5 × 15,5	2,5	6,3	2,7	0,29	0,10	-D8226-T90
47		8,5 × 15,5	1,2	3,0	1,2	0,44	0,15	-D8476-T90
100		10 × 25	0,55	1,4	0,60	0,78	0,27	-B8107-T90
220		12 × 30	0,30	0,64	0,25	1,3	0,44	-B8227-T
470		16 × 30	0,14	0,30	0,12	2,1	0,74	-D8477-T
1 000		21 × 40	0,08	0,14	0,06	3,8	1,3	-B8108-T
100		4,7	6,5 × 15,5	9,5	24	10	0,15	0,05
	10	8,5 × 15,5	4,0	10	5,0	0,23	0,08	-L9106-T90
	22	8,5 × 15,5	1,8	4,5	2,2	0,35	0,12	-D9226-T90
	47	10 × 25	0,85	2,1	1,0	0,64	0,22	-B9476-T90
	100	12 × 30	0,40	1,0	0,45	1,1	0,38	-B9107-T
	220	16 × 30	0,22	0,55	0,20	1,7	0,59	-E9227-T
	470	21 × 40	0,12	0,26	0,10	2,9	1,0	-B9477-T

Not for new design. For new design see type B 41 682, [page 365](#)

1) To obtain the required ordering code, prefix the type number to the short code. E. g.: B41283-C7226-T90  
B41283-... ( $d \leq 10$  mm)  
B41010-... ( $d \geq 12$  mm)

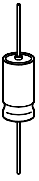

**B 41 010**  
**B 41 283**

**Useful life**

versus ambient temperature  $T_A$  under ripple current operating conditions<sup>1)</sup>

B 41 283 ( $d \leq 10$  mm)

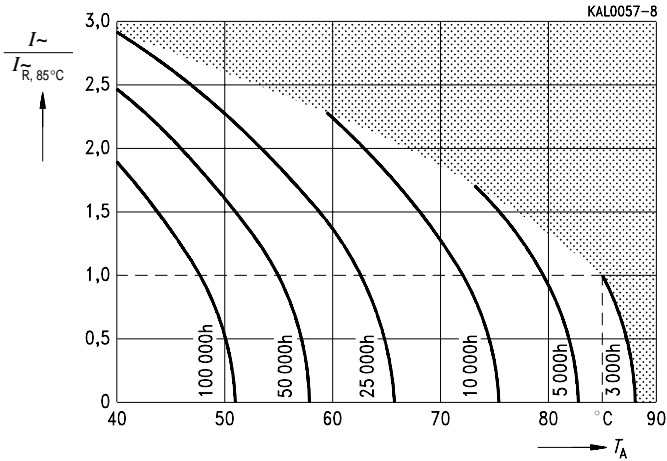

B 41 010 ( $d \geq 12$  mm)

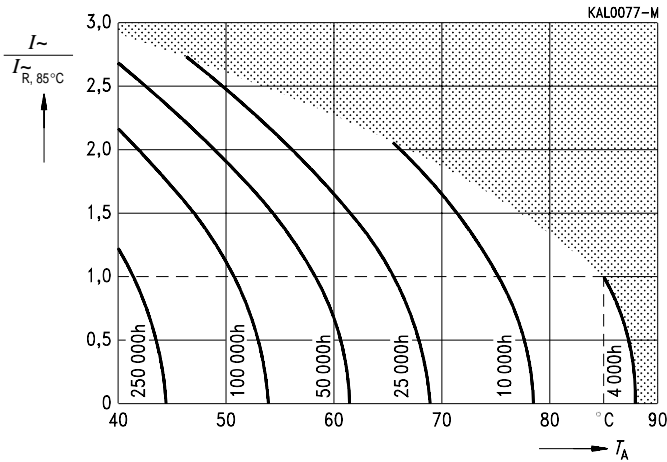

1) Refer to [page 34](#) for an explanation on how to interpret the useful life graphs.

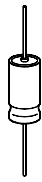

**Permissible ripple current  $I_f$**   
versus frequency  $f$

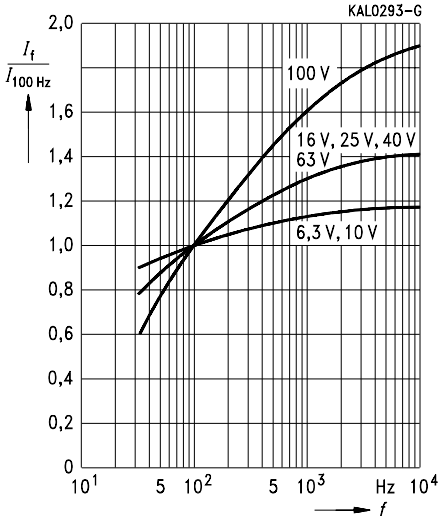

**Series capacitance  $C_s$  at  $f = 100$  Hz**  
versus temperature  $T$   
Typical behavior

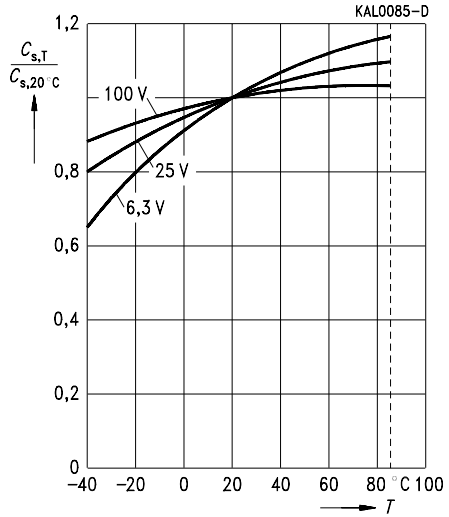

**Equivalent series resistance  $R_{ESR}$**   
at  $f = 100$  Hz  
versus temperature  $T$   
Typical behavior

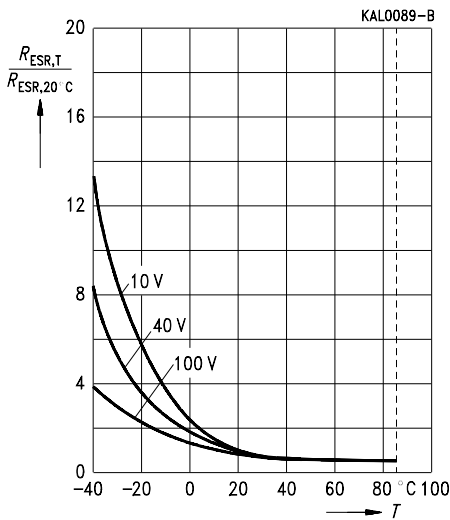

**Impedance  $Z$**   
at  $f = 10$  kHz  
versus temperature  $T$   
Typical behavior

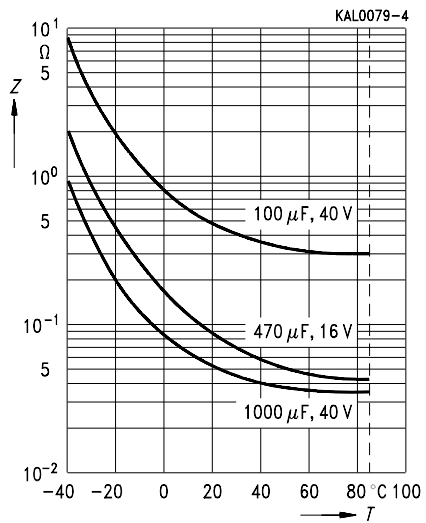



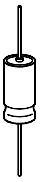

**B 41 010**  
**B 41 283**

**Impedance Z**

versus frequency  $f$   
 and temperature  $T$  for 470  $\mu\text{F}/16\text{ V}$ —  
 Typical behavior

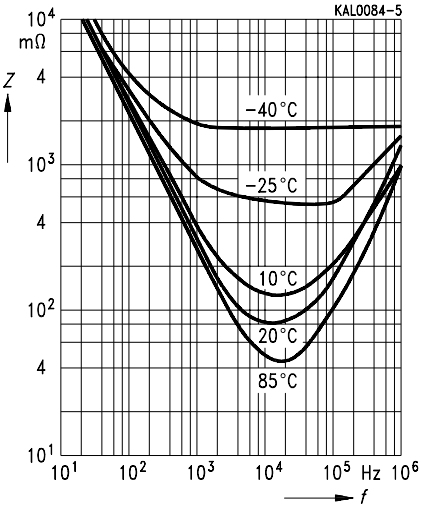

**Impedance Z**

versus frequency  $f$   
 and temperature  $T$  for 1000  $\mu\text{F}/40\text{ V}$ —  
 Typical behavior

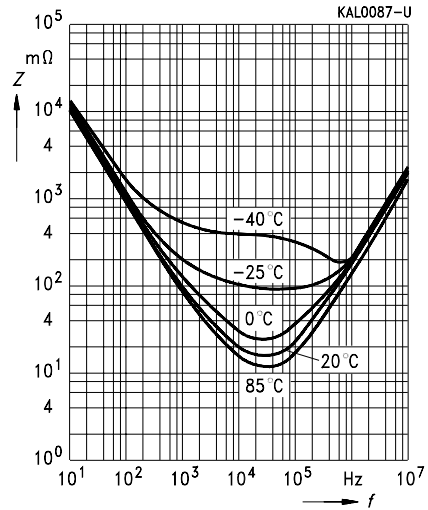

**Impedance Z**

versus frequency  $f$   
 Typical values at 20 °C  
 $U_R \leq 100\text{ V}$ —

